

Tony Ray Cook **FREE ESTIMATES**
Tree Service

- Tree Work with Bucket Truck
- Stump Grinding
- Backhoe Service
- Bobcat Work

(434) 489-2886
(434) 793-3665

www.a1economyglass.com
434-792-GLAS (4527)

www.a1customwindowtinting.com
434-822-TINT (8468)

2450 Riverside Dr., Danville VA 24540

A1 Custom Window Tinting
Economy Glass, Inc.

LLumar **SELECTPRO**
EXCLUSIVE WINDOW TINT DEALER OF **FORMULAONE**

DANVILLE'S ONLY TRANSFERABLE WARRANTY

FULL SERVICE GLASS & TINTING FOR

- Auto
- Residential
- Commercial
- Automotive Glass Replacement

INSURANCE CLAIMS WELCOME

R&D CONSTRUCTION

- Roofing • Small Repairs • Seamless Gutters
- Remodeling • Vinyl Siding • Insulation
- Foundation Inspections • Gutter Cleaning

Over 30 Years Experience

ROB TURNER **Free Estimates**
434-728-2723

Licensed & Insured • Serving VA & NC
Frankie Turner • 434-429-3790

BATHROOMS Remodeled

- Tub/shower conversions
- Partial or full remodel

(434) 724-1026

www.bathrem.com Over 30 years exp.

BERNARD & SONS
Tree & Lawn Care

- Tree Removal/Trimming
- Stump Grinding
- Lawn Care / Maintenance
- Mulch Delivery & Spreading

434-770-3244
FREE ESTIMATES!

Insured

“Your hometown paper by hometown people”

Piedmont Shopper

C&D FAMILY PAWN SHOP
Where everyone is treated like family!

650 Piney Forest Rd. Danville, VA
434.791.2366

Riverside Pawn

Stop by Danville's #1 Pawn Shop Today
Home of TOP DOLLAR Loans!!

2384 Riverside Drive, Danville, VA
434-792-7296

1380 Piney Forest Road, Danville, VA
4003 Halifax Road, South Boston, VA
1601 Virginia Avenue, Martinsville, VA

2020 READERS' CHOICE AWARDS
Danville Register & Bee

showcase magazine
RAVE
bavonix

MUSIC ON MAIN
DANVILLE VA

AUGUST 27
JUS' CAUZ BAND

DUE TO SOCIAL DISTANCING RESTRICTIONS, THERE IS A CHANGE IN LOCATION FOR 2020 SHOWS. ALL CONCERTS WILL BE HELD AT THE CROSSING AT THE DAN COMPLEX. 629 CRAGHEAD STREET. AT 7 P.M. THERE IS NO FEE. BRING A LAWN CHAIR OR BLANKET AND A PICNIC BASKET! CALL 434.793.4636

DANVILLE HARVEST JUBILEE

YOUR HEALTH AND SAFETY REMAIN OUR #1 PRIORITY

We are taking the extra steps to ensure a safe environment when you come for care. Our team of healthcare heroes is here for you today and always. Here are a few of the steps we are taking:

Enhanced Cleaning And Stocked With Supplies

Our team performs extensive disinfecting procedures throughout the day, and we are constantly monitoring supplies and staffing to make sure we have what we need to care for you.

Face Mask Requirement

We require everyone who walks into our facility to wear a mask. And all our staff wear masks, for your protection and theirs.

Safe Social Distancing

Areas such as waiting rooms have been adjusted for six-foot social distancing.

Ready For You

Whether it's a routine appointment, cancer screening or surgery, don't delay care that is important to your health.

Learn more about the safety steps we've taken at **SovahHealth.com**



Don't let COVID-19 interrupt your degree plans.

Affordable, local learning: online.

DANVILLE.EDU/NEXTSTEPS

JOIN THE DCC FAMILY!

DCC Danville Community College

FOLLOW @DCCPR | WWW.DANVILLE.EDU

Who do you want to be tomorrow?

This facility and its affiliates comply with applicable Federal civil rights laws and does not discriminate on the basis of race, color, national origin, age, disability, or sex. ATENCIÓN: si habla español, tiene a su disposición servicios gratuitos de asistencia lingüística. Llame al 1-434-799-2100 (TTY: 1-800-828-1120). 주의: 한국어를 사용하시는 경우, 언어 지원 서비스를 무료로 이용하실 수 있습니다. 1-434-799-2100 (TTY: 1-800-828-1120)번으로 전화해 주십시오.

MAGIC MAZE ● **THINGS WITH ELECTRIC MOTORS**

O P N K I G R D B Z X V S Q O
 M G K R I G E E C A Y T R W U
 S A Q P E N L J X H R F E E C
 A R Y X V W S L L I R D D W U
 S A Q P N M O K M J M H D A F
 E G C L O C O M O T I V E S S
 H E A T E R E D N E L B R D P
 B D R Y E R Z Y X W V U H N M
 C O M P U T E R T C A R S A U
 R O S S E R P M O C R L Q B P
 P R E N O I T I D N O C R I A

Find the listed words in the diagram. They run in all directions forward, backward, up, down and diagonally
 Unlisted clue hint: WASHER AND —

- | | | | |
|-----------------|-------------|-------------|----------|
| Air conditioner | Compressor | Heater | Pumps |
| Band saw | Computer | Lawn mower | Shredder |
| Blender | Drills | Locomotives | Trimmer |
| Cars | Garage door | Mixer | |

©2020 King Features Syndicate, Inc. All rights reserved.

BIBLE TRIVIA
 by Wilson Casey

1. Is the book of Isaiah in the Old or New Testament or neither?
2. A number of herbs and spices are mentioned in the Bible (KJV). Which one is mentioned the most? Salt, Pepper, Sage, Thyme
3. Whose first chapter begins, "The former treatise have I made, O Theophilus"? Matthew, Luke, John, Acts
4. In 2 Kings 1, what Philistine city worshiped Baal-zebub? Ekron, Succoth, Gomorrah, Antipatris
5. From Acts 9, where did Peter cure Aeneas? Tyre, Neapolis, Lydda, Gibeon
6. In Numbers 20, where did Aaron die? Mount of Olives, Pisgah, Mount Hor, Gilboa

ANSWERS: 1) Old; 2) Salt; 3) Acts; 4) Ekron; 5) Lydda; 6) Mount Hor

Hardcore trivia fan? Visit Wilson Casey's subscriber site at www.patreon.com/triviaguy.

top ten
 Most Crowded U.S. Islands

1. Manhattan
2. Roosevelt Island (NYC)
3. Balboa Island (Newport Beach)
4. City Island (NYC)
5. Long Beach Island (NY)
6. Staten Island
7. Long Island
8. Lido Isle (Newport Beach)
9. Oahu
10. Key West

Source: Wikipedia
 © 2020 by King Features Syndicate, Inc. World rights reserved.

Relax, we'll do the housework.

- Daily • Weekly
- Bi-Weekly
- Monthly Services

• COMMERCIAL
 • RESIDENTIAL
 • INDUSTRIAL

We Also Buff & Wax Floors

A HELPING HAND CLEANING SERVICE
 FREE ESTIMATES • LICENSED • BONDED • INSURED
 Shannon Blachura (434) 548-9911

Purchase tickets online at www.bluegrassbytheriver.com or ...
 in person at 2 Witches Winery & Brewery Co. 209 Trade Street, Danville, VA

Lonesome River



With Special Guest...
Grammy Winner and former guitarist for Merle Haggard
Redd Volkaert

SHELTON & WILLIAMS



JAY SHELTON JEANETTE WILLIAMS JOHNNY WILLIAMS

\$15 IN ADVANCE **GATES OPEN 5:00**
NO TICKETS SOLD AT GATE **CONCERT STARTS 6:00**

RAIN OR SHINE **BRING LAWN CHAIR**
NO REFUNDS

SPONSORS *Proceeds go to local chapter of Project Lifesaver*



Sept 12th
2020 6 pm

TICKETS **\$15** IN ADVANCE **\$20** DAY OF

BLUEGRASS by the RIVER
CONCERT

LOCATION
 2 Witches Winery & Brewery Co
 209 Trade Street
 Danville, VA 24541

We will be following the current CDC & VDH guidelines

Concessions available from
Soul Food Express

@bluegrassbytheriver

Junior Whirl
 by Charles Barry Townsend



WHILE TIMMY IS COOLING OFF with a Clam Spritzer, see if you can count how many shells are in the picture. We found more than 30.

SEE IF YOU CAN make this math expression correct by adding four plus signs between certain numbers:
1 2 3 4 5 6 7 = 100
 Answer: 1 + 2 + 3 + 4 + 5 + 6 + 7 = 100.

FIND-A-WORD! On the top line is our mystery word. You need to fill in the missing letters. Clue words (smaller words contained in the letter-by-letter order within the mystery word) are defined below.

1. To load up.
2. A drink ending.
3. Very willing.
4. A young man.

Answers: 1. Load; 2. Ade (lemonade, orangeade, etc.); 3. Glad; 4. Lad. Mystery word: Glade

ANOTHER TYPE OF TEA PARTY!
 A good way to end the day is with a nice cup of tea. It's also a good way to end the following 14 words. We give you hints for each. (For example: Great speed equals velocity.)

1. Methuselah had it.
2. Type of drink or snowman.
3. Made to look foolish.
4. The spice of life.
5. The soul of wit.
6. Used in quiet cars.
7. Cordial reception of guests.
8. The best policy.
9. A criminal's dread.
10. A skill with hands.
11. Everlasting.
12. A sailor's song.
13. Can keep you down.
14. A stale odor.

Answers: 1. Longevity; 2. Frosty; 3. Indignity; 4. Variety; 5. Bravely; 6. Electricity; 7. Hospitality; 8. Honesty; 9. Cavalry; 10. Dexterity; 11. Eternity; 12. Chaney; 13. Granity; 14. Stale odor.

Piedmont Shopper
 2804 Westover Drive • Danville, VA 24541

Mail Us Your Ad On This Form

FREE Ad? PAID Ad?

FREE ADS 25 Words Or Less. 25 Cent Per Word After That.
 Please Include Payment For PAID ADS & Special Additions. Make Checks Or Money Orders Payable To The Piedmont Shopper

Special Ad Additions:
 Photo \$5 Reverse Print \$2 Boxed Ad \$2

Category: _____
 AD Info: _____

NAME: _____
 ADDRESS: _____
 PHONE: _____

MANY WAYS to get a classified ad in the Piedmont Shopper:

- 1 Go to www.piedmontshopper.com
- 2 Email to: ads@piedmontshopper.com
- 3 Mail Using form on left
- 4 Call or text Ads Hotline 434.822.1111
- 5 Call office 434.822.1800

Samantha Worley
 Classified Ad Sales

Piedmont Publishing INCORPORATED
 Established 2001

Piedmont Shopper
 www.piedmontshopper.com

Advertise YOUR business in the Piedmont Shopper, in print and online!

For Display Ads (boxed ads) from business card size up to full page...

Call Now!

Lesley Norton
 Display Ad Sales
 Danville/Pitts. County
 434.489.1382
 Email: lesley@piedmontshopper.com

Stephanie Hyatt
 Display Ad Sales
 Roxboro/Person County
 South Boston/Halifax
 434.250.5272
 Email: stephanie@piedmontshopper.com

2804 Westover Dr Danville, VA 24541
 Office 434.822.1800 Fax 434.822.2400
 New Office Hours: Monday - Thursday 9 - 5
 Email: info@piedmontshopper.com

Kathy Crumpton Owner/ Publisher
 Joey Van Pelt Graphic Design

AIRPARK STORAGE



- 24 Hour Electronic Access & Video Surveillance
- Units 5x10 to 10x30 (Large Enough For Boats & RV's)
- Commercial & Residential
- Monthly Rental Available
- U-Haul & Storage Supplies Available
- Office Hours: Mon.-Fri. 8-5 • Sat. 9-1
- Fenced & Lit at Night For Added Security

822-4160
www.selfstorage.com/airparkstorage

Route 58 East Across From Airport Behind Sleep In
Bring in this ad for 1 FREE month rental
New Tenants with Free First Month. Not Valid With Any Other Offer. Expires 12.31.20. Discount Does Not Apply to Climate Control Units.



1. LITERATURE: What was the name of Hermione's pet cat in the "Harry Potter" series?
2. GENERAL KNOWLEDGE: What is the name of the metal band that attaches a pencil and an eraser?
3. ANIMAL KINGDOM: What is a group of giraffes called?
4. GEOGRAPHY: Which state claims Mackinac Island in Lake Huron?
5. TELEVISION: What was the name of the coffeehouse in the "Friends" sitcom?
6. U.S. PRESIDENTS: How many presidents have died in office?
7. MEDICAL: What is the common name for lachrymation?
8. LANGUAGE: What is the American English version of a British flannel?
9. HISTORY: Who was the last czar of Russia?
10. MUSIC: What was the original name of the pop rock group Maroon 5?

Answers

1. Crookshanks
2. A ferrule
3. A tower
4. Michigan
5. Central Perk
6. Eight
7. Flow of tears
8. A washcloth
9. Nicholas II
10. Kara's Flowers

(c) 2020 King Features Synd., Inc.

Duck

A kindergarten teacher handed out a coloring page to her class. On it was a picture of a duck holding an umbrella.

The teacher told her class to color the duck in yellow and the umbrella green. However, Rian, who always does things HIS way, colored the duck in a bright fire truck red.

After seeing this, the teacher asked him: "Rian, how many times have you seen a red duck?"

Young Rian replied with "The same number of times I've seen a duck holding an umbrella."



www.bandproofing.com
434-429-7108

Community Calendar AUGUST

S	M	T	W	T	F	S
-	-	-	-	-	-	1
2	3	4	5	6	7	8
9	10	11	12	13	14	15
16	17	18	19	20	21	22
23	24	25	26	27	28	29
30	31	-	-	-	-	-

Community Events

Adventist Community Service is NOW OPEN for Free Food, Clothes and Furniture. Donation Sale for the Whole Month of August. Tuesdays, Wednesdays and Thursdays from 11:00AM-3:00PM. Located at 212 Ingram Rd, Danville. Call 434-710-1216.



ARIES (March 21 to April 19) A relaxed mood early in the week could give way to high-temperature disputes. The Aries Lamb should resist being pulled into heated quarrels that could really singe your wool.

TAURUS (April 20 to May 20) Satisfy that practical obligation first, then you can feel free to indulge in your creative endeavors. Also, check for hidden or overlooked areas where repairs might be long overdue.

GEMINI (May 21 to June 20) Home is still the Twins' major focus this week. But outside matters begin to take on added importance, especially those involving possible career moves. Stay alert for signs of change.

CANCER (June 21 to July 22) A travel plan might need to undergo some considerable adjustment because of unexpected changes. Keep an open mind and let the facts guide you on how you want to handle this.

LEO (July 23 to August 22) Playing cat and mouse with a matter you don't really want to tackle wastes time, energy and, most important, an opportunity. Ask someone with experience to help you get started.

VIRGO (August 23 to September 22) A shift in policy might not please you, but before you put up a "no go" wall of resistance, examine the circumstances. You might be quite pleasantly surprised by what you find.

LIBRA (September 23 to October 22) Yesterday's critiques about your methods might have already evolved into today's praise for your achievements. Good for you. Now go on and continue to build on your credibility.

SCORPIO (October 23 to November 21) An occasional temperamental flare-up might occur as you continue to help get things back to normal. Stay with it. You should soon get some idea of where to take things next.

SAGITTARIUS (November 22 to December 21) A negative reaction to what you believe was a well-deserved request might mean that you need to reconsider your position and make changes accordingly.

CAPRICORN (December 22 to January 19) There's always room for someone new at the Sea Goat's table. And the someone new this week could bring a message you've been waiting a long time to hear.

AQUARIUS (January 20 to February 18) A pile-on of personal matters this week might seem too overwhelming to deal with. But handling them on a one-by-one basis could have you out from under it by the weekend.

PISCES (February 19 to March 20) A friend might need your good advice regarding a matter. Be supportive. But unless you can be absolutely sure you have all the facts, be careful about any suggestions you might be asked to offer.

BORN THIS WEEK: Few things make you happier than bringing people together and helping to forge new friendships.

The Spats

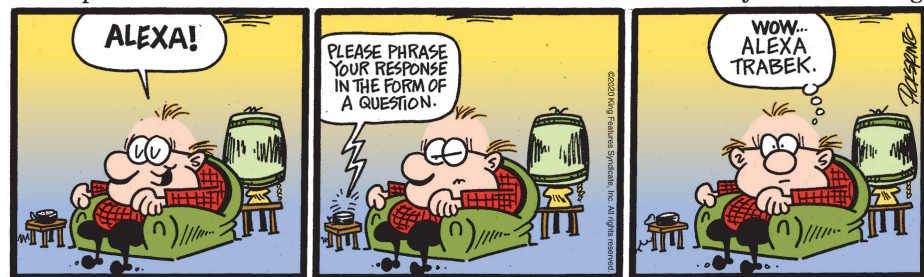

by Jeff Pickering

NOW OPEN!



Discover timeless treasures from several unique dealers!

Vintage & Antique Marketplace

- Art Deco Design • Modern Furniture
- Retro Kitchenware • Glass & Dishware
- Estate Jewelry • Vintage Clothing
- Collectibles & More

Dan River
ANTIQUES

530 Monroe Street | Danville, VA 24541
434-791-4020 | www.danriverantiques.com

Shop Tues - Fri 12 - 5 • Sat 10 - 2

Stay connected on social media for new merchandise arrivals

HOCUS-FOCUS

BY HENRY BOLTIHOFF



Find at least six differences in details between panels.

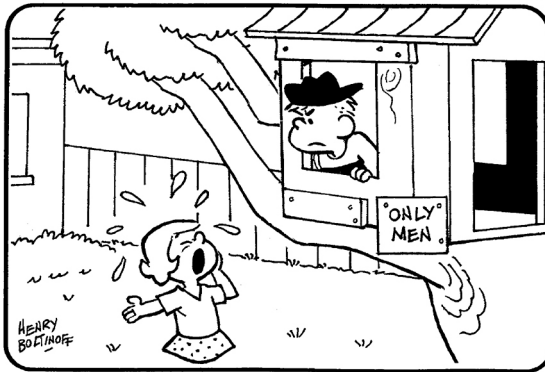

Differences: 1. Girl's bow is missing. 2. Tree limb has been added. 3. Boy's shirt has stripe. 4. Sign is different. 5. Treehouse roof is different. 6. Tree steps are gone.

**Dear Lord,
Please don't let Brussel Sprouts
be a part of the cure of Covid-19 Virus.**



Weekly SUDOKU

by Linda Thistle

		1		9	5	7		
6				7			3	
	4		1					2
	5				1	4	7	
9				6				3
2	7	8				9		
	9		3	2			6	
1			4					8
		6		8		2		

Place a number in the empty boxes in such a way that each row across, each column down and each small 9-box square contains all of the numbers from one to nine.

DIFFICULTY THIS WEEK: ◆

- ◆ Moderate ◆◆ Challenging
- ◆◆◆ HOO BOY!

© 2020 King Features Synd., Inc.

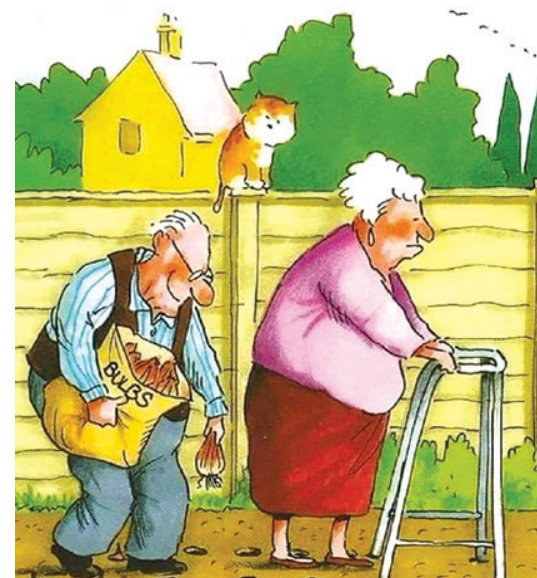

Need Fast Cash?

Come see us at:



CD FAMILY PAWN SHOP
"There's always a market for your things"

today for loans!

We pay cash on the spot for valuable items!

650 Piney Forest Rd., Danville, VA
434.791.2366 • Find us on Facebook

HOLBROOK TREE EXPERT, CO.

42 Years Experience
FREE ESTIMATES!
Insured

FIREWOOD FOR SALE!
We Do Heavy Duty Bushhogging!
We Have A 75 Foot Bucket Truck!

336-459-6035
440 Poole Road, Pelham, NC

COMFORT COOLING HEATING & AIR

"Where Quality Matters"

Expert fast and reliable installation, maintenance & repair for all your heating, cooling, and plumbing needs!

Locally Owned & Operated
434-791-2051 • www.orangevans.com

We are a family oriented establishment. Serving homecooked meals to you daily.



Westside Diner
HOME COOKING • DAILY LUNCH SPECIALS • HOMEMADE DESSERTS

1555 Meadowview Dr. • Danville, VA • 434-685-3075

DINING ROOM NOW OPEN!
Tues - Thurs 11a - 8p | Lunch & Dinner
Fri - Sat 7a - 8p | Breakfast, Lunch, Dinner
Sun 7a - 2p | Breakfast & Lunch | Mon CLOSED

Animal Medical Center Pet Grooming! Certified Master Groomer with 35 Years of Experience. Call 434-793-6477. By Appointment Monday-Friday. groomingatamc.com

FREE Kittens!! For More Information, Call BEFORE 10:00PM, 434-709-1173.

Large Puppy Pads, 15 Count. Asking \$3 a Pack. Call 336-694-3523.

Cats/Kittens Need a Forever/Loving Home: They are Beautiful, Sweet, and Litter Box Trained. Call 434-251-5377. If No Answer, Please Leave a Name and Number.

Happy Birthday David Moore August 25th. You are 74 Now. Love Mary Ann.

Looking for a Roommate in the South Boston Area, \$300 a Month. For More Information, Call 434-476-1580.

Happy 58th Birthday to My Mother, Teresa Hudson!! From, Frankie and Family

Looking for Someone that does Calligraphy by Hand. Call 434-429-6585.

Handmade Face Masks: All Colors and Patterns. Asking \$8 Each. Call Judy at 434-793-5013 or 434-688-9063.

SINGLE MOMS SUPPORT GROUP: Starts 9/2 at 6:30PM. Group Meets 1st and 3rd Wednesdays of Each Month at 1543 Piney Forest Rd, Danville. **FREE Dinner and Childcare is Provided.** For More Information, Call Brenda at 434-203-9106.

DAN RIVER HIGH SCHOOL REUNION! DAN RIVER HIGH SCHOOL 1970 CLASS 50TH YEAR REUNION! Sat 9/19 from 4:00PM-Dusk. ANGLER'S PARK, 350 Northside Dr, Danville. \$10.00 Per Person. Call 434-728-2355.

Outdoor Hot Dog Supper Sunday August 30th, 5pm at Woodlawn Baptist Church. 2500 Westover Dr. Danville, Va. With special guest speaker Bob Good. We will be encouraging social distancing for this event.

Looking for the Buyer of the 2000 Toyota Tacoma SR5, Tan Color. Bought last year by a man from Appomattox. Please Call 434-799-5430.

We Buy Junk Vehicles: Inoperable, and Tagged by the City. Same Day Pickup and Payment. Call 434-489-8440.



Students Improve through Tutoring: If you are in Danville or the Surrounding Areas and are Looking for a Tutor for Your Child, I am a Retired School Teacher with Over 40 Years Experience- Grades K-5. I Love Helping Children Achieve their Highest Potential! I am available Immediately and through the Upcoming School Year. You can reach me on my Cell Phone at 678-761-3553. I Look Forward to Working with many Wonderful Children and their Parents!

Antiques

Zenith Radio Phonograph Combination with papers. Asking \$50.

Hanes, Voice Magazines, Bits, Halters: Large Amount of Horse Related Items. Different Prices. Going Out of Business. Over 50 Years. Call 434-429-9781. (434) 429-9781 green6594@hotmail.com

Animals & Accessories

Wanted to Buy Labrador or Golden Retriever mix puppy. Call 434-792-2066

Wire Horse Fencing For Sale 4x100 wire rolls. \$90 per roll. Call 434-441-8702.

Electric Dog Feeder \$20.00 Brand new, never used, still in box & cover (276) 618-1829 ccat4904@yahoo.com

Dog crates 3 metal dog crates, 2 larger with 2 doors, 1 small \$20-\$25.00 (276) 618-1829 ccat4904@yahoo.com



Bonz -N- Bubbles: Self Service Dog Wash and Spa. Making Pets Feel Right at Home With a Low Stress Environment. No Need to Subject Your Dog to Cages or Strangers. You Wash Option Keeps Your Pet Calm and In Your Care. We Wash, and Our Grooming Services are Staffed by Knowledgeable, Courteous, and Certified Professionals, using State-of-the-Art Equipment, and All Natural Products. 2018 Riverside Drive (Paw) Danville, Va (Paw). 434-857-5057, www.BonzNBubbles.com

Wanting 2 Female Kittens, Small. Call 434-425-2048 or 434-709-6929.



Grooming, Boarding and Daycare! Full Service All Breed Grooming for Comfort and Style! Full Indoor/Outdoor Kennel with Climate Controlled Runs and Large Outdoor Play Area. Boarders Allowed to Join in Daycare at No Extra Charge! Daily, Weekly and Monthly Doggie Daycare to Fit All Budgets! Best Deals in Town! Call for Pricing, 434-836-2801, or Visit: www.mthermon-petgrooming.com

FREE PICK 3 SPA PACKAGE! For New Clients on their First Visit Only. Not Valid with Any Other Offers. Danville Family Vet, 280 Piney Forest Rd. Call 434-836-2499.



FREE VET EXAM AND 5% CASH REWARDS ON ALL PURCHASES FOR 1 YEAR. For New Clients on their First Visit Only. Not Valid with Any Other Offer. Mention this Ad at: DANVILLE FAMILY VET, 280 Piney Forest Rd. 434-836-2499.



Announcements

The Stone and Fitts Family Thanks each one for their kindness during the Bereavement of Antonio "Tony" Fitts.

HAPPY BIRTHDAY TO MY BROTHER JIMMY CRAFT AUGUST 23rd!!! HAVE A GOOD ONE! WANDA

Happy Birthday Uncle Jimmy on August 23rd!!! Love ya! Sam.

PIEDMONT PETS

August 20, 2020
By Paulette Dean

My 16 year-old cat, Becky, has pain in her knees due to severe arthritis. She has been getting shots every 4-6 weeks for almost a year. The relief from pain does not last as long as it used to and there are no permanent solutions to this.

The morning of August 17th, her veterinarian since she was four months old and I had a difficult conversation. We agreed upon a new medicine regimen for ten days and then will re-evaluate.

I knew that the conversation would be a difficult one and I knew I would trust the opinion. Why? Her veterinarian knows that I do not want my beloved cat to be in pain. She knows Becky very well; she spayed Becky at four months, and has also performed four additional surgeries throughout her life.

This is the value of having a relationship with a veterinarian that comes from regular veterinary visits.

One of the best things that a pet owner or guardian can do for their animal friend is to have such a relationship with a veterinarian. Whether people adopt, buy, or are given a pet, the safest action is always to take that animal to a clinic for an examination, updated vaccinations (if needed) and any preventive care that will help that animal lead a long, happy life.



996 South Boston Rd., Danville, VA 24540
Phone: (434) 799-0843

I know that when the time comes, Becky's vet and I will talk and I will cry; she probably will, too.

However, we have a level of trust and that leads to the best decisions for beloved pets.

We urge anyone with a pet to establish a relationship of trust with a veterinary clinic. Visit different clinics and ask questions. Then, make sure that you maintain that relationship through routine visits and annual check-ups.

Years later (hopefully), when the time comes to make a difficult decision, you can be comforted by the fact that two people who love your pet weighed the pros and cons of every avenue of treatment and made the best decision.

THOUSANDS IN SAVINGS



 2011 Toyota Tacoma SR5 White, Crew Cab, 4WD, V6, Towing Package 152k Miles \$16,999	 2009 GMC Denali Black, AWD, V8, 204k Miles • Lowes Dr. Branch \$14,999	 2011 Mitsubishi Outlander SE White, AWD, 293k miles • Lowes Dr. Branch \$4,999
 2014 Sea-Doo RXT-X 260 50 Hours, Price Includes a 2020 Yacht Club Trailer \$11,074	 2014 Buick Enclave Tan, 2WD, V6, Leather, Bose Stereo, Navi, Sunroof 46k Miles \$18,999	 2019 Chevrolet Spark Gray, Manuel Transmission, Hatchback 8k Miles \$12,999
 2007 Honda Element Red, 4WD, 2.4L, 206k miles • Lowes Dr. Branch \$6,599	 2010 Toyota 4 Runner Silver, 2WD, V6, Leather, SR, Towing pkg. 198k Miles • Lowes Dr. Branch \$15,499	 2015 Jeep Renegade Latitude Gray, 2wd, Bluetooth, Back up camera, Power Seat 64k miles • Lowes Dr. Branch \$13,499
 2008 Chevrolet Suburban Z-71 Burgundy, 4WD, V8, Towing Pkg. Rear Entertainment, Sunroof 193k Miles	 2012 Chevrolet Camaro Red, AT, 2 DR, SR, Back Up Cam, remote Start. 84k Miles. • Lowes Dr. \$12,199	 2017 Chevrolet Camaro Gray, AT, 2DR, Convertible 40k miles • Lowes Dr. Branch \$25,999
 2014 Nissan Altima S Silver, AT, 4DR, 63k Miles • Lowes Dr. Branch \$9,699	 2010 BMW 7 Series Silver, AT, Sport Pkg, Rear Ent., Driver Assist. 138k Miles • Lowes Dr. Branch \$13,099	

Call today 434-799-1279 to schedule a test drive!

Financing Available with rates as low as 2.99%

Vehicles can be seen at Lowes Drive or Arnett Blvd locations - see description or call for more info. Financing is available at low APR for qualified buyers. Extended Warranty and GAP also available for purchase. Please see a loan officer for complete details. All vehicles are sold "AS IS" condition. We do not know anything regarding the mechanical condition of these vehicles. *With approved credit. See loan officer to see if you qualify and for complete details. There is no warranty expressed or implied. Other vehicles may be available and will be priced as they become available for sale.

Financing available with approved credit.
Call today to schedule an appointment to see vehicles and meet with a loan officer

314 Lowes Drive, Danville VA
Hours: 9am - 5pm Monday - Friday • www.urwfcu.org • 434.793.1278

S & B Motor Co.

2012 SUBARU IMPREZA 2.0I LIMITED



AWD, Pearl White, Only 58k miles, AT, Leather, Very Clean & Nice!! Stk# P5614A

2331 Riverside Drive, Danville VA
434-793-1511 • Hrs: Mon-Fri 8am-5pm • Sat 9am-1pm

View more photos of this vehicle plus search our entire inventory online at www.sandbmotorsco.com

AUTO VILLA PRE-OWNED SUPERCENTER

434-791-4000

Offering Low Interest Rates!

"WE FINANCE"
Cash Offers "Welcome"
RIDE TODAY!
Bad Credit, No Credit
NO PROBLEM
With Approved
Down Payment.

Car Fax Vehicle History Reports **928 Riverside Drive Danville, VA 24540** View Vehicles www.autovillaofdanville.com

 <p>2012 Dodge Grand Caravan Black, AT, AC, 7 Passenger</p>	 <p>2014 Dodge Ram 4Dr, 4x4, Gray, Hemi 2013 Dodge Ram 1500 Burgundy, AT, AC, 92k Miles</p>	 <p>2019 Chevrolet Equinox White, AT, AC, 4DR, 3k Miles 2018 Chevrolet Equinox LT Green, AT, AC, 4Dr, 25k miles</p>	 <p>2014 Chevy Camaro Yellow, V6, 6 speed, AC, loaded 30k miles</p>
 <p>1998 Toyota Tacoma - Xtra Cab 4x4, Green, AT, AC, 4cyl. 2000 & 2003 Toyota Tacoma Reg Cab - 2wd</p>	 <p>2014-2018 Altimas, Sentras. 2010 370z in Stock.</p>	 <p>2016 Kia Soul Green, AT, AC 59k Miles, AT, AC</p>	 <p>2006-2019 Honda Accords & Civics, several in stock.</p>
 <p>2014 - 2018 Chevy Impala's, Malibu's & Cruze. Several in stock.</p>	 <p>2017 Mazda 3 Touring Blue, AT, AC, 4 Door, Low Miles</p>	 <p>2014 Nissan Pathfinder SL Silver, AT, AC, Loaded 2014 Nissan Rogue Burgundy, AT, AC, AWD</p>	 <p>2016 Jeep Renegade Green, AT, AC, 4 Door, 21k Miles</p>
 <p>2015 Nissan Titan S White, Xtra Cab, 4 Door, AT, AC, 2WD.</p>	 <p>2015-2017 Kia Fortes and Rios AT, AC, Low Miles</p>	 <p>2011-2016 Toyota Camrys, Corollas, Avalons 4 Door. AT, AC, Great on Gas</p>	 <p>2004 BMW 330i Black, AT, AC, Sunroof, Loaded.</p>

Kristy's AUTO SALES

Need Help Selling Your Vehicle?
Contact Us about Consignment Options

VADLR #053420 • 434-799-4610
4756 Mount Cross Rd • Danville, Va. 24540

Daisy 70th Anniversary BB Gun: Red Ryder in Original Box, in Excellent Condition. The Stock and Forearm are Solid Wood. Lever Action 650 Shots, 350 FPS, 195 Yards, 2.2 LBS, 35" Long, 177 Caliber. Asking \$100. Call 434-429-9781. (434) 429-9781 green6594@hotmail.com

Large Green Egg Grill, Brand New, on Roller Stand. Includes Side Shelves, Cover and Cookbook. Asking \$800 OBO. Call 434-203-7684.

Looking to Buy Top Load Washer, and a Chest Style Freezer, in Good Working Condition. Also, Need Refrigerator. Less than 10 Years Old. Call 434-228-5669.

Gas Kitchen Range, Washer and Dryer, and Large Window AC. Asking \$300 for All. Call 434-713-4952.

Wood Range Hood Cover: Never Used or Finished. Asking \$50. Call 434-429-0786.

GE Stackable Washer/Dryer: White with Stainless Drums. 2 Years Old, Used Very Little. In Mint Condition. Paid \$1,495. Asking \$850. Text for Pictures and Information, 434-250-7383.

GE Gas Stove, with Broiler Oven. Black and Stainless. If Used, Very Little. \$850 New, Asking \$400. Text for Pictures and Information, 434-250-7383.

Whirlpool Washer/Dryer Combo: Cabrio Model, Like New. Used Very Little. Both Works Great. White, Purchased New. Call for Price, 434-425-3871.

Looking to Buy a Refrigerator, Used, in Good Shape, and a Chest Type Freezer, in Good Shape. Both Must Work. Call 434-432-1416.

Larry's Appliance Doctor: Repairs for Washers, Dryers, Refrigerators, Dishwashers and Stoves. All Brands, US and Foreign. Call 434-548-7771.

Antique chairs/settees wanted \$1 Looking to buy any old antique/vintage/Victorian chairs or settees! (540) 355-8360 jhamm3101@gmail.com

Antique Solid Cherry China Cabinet \$250.00 (276) 632-0886 fcorbin1604@gmail.com

We Buy Antiques, Furniture, Glassware, and More. Call 434-251-6323.

2 Gone With The Wind lamps for sale. Call 434-770-2502 for price and more details.

Antique Furniture Cheap 9 Piece chimney liner. \$75. Call 434-421-2233

Apparel, Jewelry, Clothes

Womens Bandolina Jean's 7 pair Womens size 18 short jeans for sale. Asking \$7 each. Call 434-770-6757 (434) 770-6757

Boots \$25 New boots not worn at all size 5 (434) 770-1109 pauline.b1@mail.com

Ladies boots \$25 just like new size 9 (434) 770-1109 pauline.b1@mail.com

Poncho \$5 (434) 770-1109 pauline.b1@mail.com

Women's Plus Sizes: 1X to 5X, 14W to 32W. Many New With Tags! Also, Shoes, Purses and Jewelry. Your Stuff Consignment Boutique, 434-836-1450.

Alterations: Alterations Starting at \$3.00 and Up. Hemming of Pants, Skirts, Shirts. General Mending and Repairs. Call Barbara at 434-799-2594.

Summer Shirts for Sale: Different Sizes. For More Information, Call 434-836-3615.

Handmade Face Masks: Fabric Face Masks. Asking \$3 for Adults, kids 2/\$5.00. Various patterns and solid colors available. Call Barbara for Details at 434-799-2594.

Guys AE Jeans, Size 32: 2 Pair, in Great Condition. \$15 a Pair, or \$30 for Both. Call or Text 434-713-2734.

Selling Crocheted Baby Outfits: New Assorted. Starting at \$40. For More Information, Call 267-304-6062.

Appliances

Looking to Buy a Dryer, in Good Condition. Call 434-792-5273.

2017 Refrigerator/Freezer 2017 Kenmore Refrigerator/Freezer off white, 18.5 cubic ft. (434) 770-2509 bitspieces2@gmail.com

Audio/ Video

Assortment of VHS Movies: For More Information, Call 434-575-0999.

Cordless Telephone/Answering System AT&T TL96456, Bluetooth Wireless: 1 Base, 1 Handset, 1 Power Adapter. (User's Manual is Online). New. Asking \$10. Call 434-792-7405.

Cordless Telephone/Answering System: AT&T TL96456, Bluetooth Wireless: 1 Base, 4 Handsets, 3 Cradle/Chargers, 4 Power Adapters, User's Manual. Like New. Asking \$30. Call 434-792-7405.

2 Sony VCR Players with Remotes, Asking \$30 Each. 2-13" Color TV's with Remotes, Asking \$20 Each. Not Flat Screen. Call 434-429-7658.

Auto

Auto Cars

2007 Dodge Charger Red, New Paint and Transmission, Good Strong Car. For More Information and Price, Call 434-575-0999.

2008 Chevrolet Impala Super Sport; Fully Loaded, V8, Black. Call for Price, 434-575-0999.

1999 Chrysler Concorde 128K Miles, New State Inspection. Asking \$1,500 OBO. Call 434-476-1580.

1966 Ford Custom MT, Blue with Blue Interior, 50K Miles, Off Frame Restoration. \$6,000 in Receipts for New Parts, Original Parts Sandblasted and Powder Coated. Asking \$8,000 OBO. Call 336-309-3856.

1965 Ford Mustang: PARTS CAR. 6 Cyl Engine. Asking \$1,200. Call 434-203-1176.

2002 Honda Accord Sdn 5 Spd, Leather Interior, Sunroof, New Tires. Needs Front Clip. Asking \$700, Negotiable. Call 903-519-1569.

1999 Nissan Altima in Good Condition. Asking \$1,000. Call 336-234-8518.

2002 Toyota Corolla Gray, AT, AC, 4 Door, 122K Miles. Asking \$3,995. VADLR. For More Information, Call 434-791-4610.

2008 Mercedes-Benz E-Class E350 Series: Silver, AT, AC, Loaded. 53K Miles. Call for Price. VADLR 434-791-4000

2017 Kia Rio Red, 4 Door, AT, AC, Great on Gas. 26K Miles. Call for Price. VADLR 434-791-4000

2011 Toyota Camry Gold, 4 Door, 6 Speed, AC, Low Miles. VADLR 434-791-4000

2016 BMW 2 Series 2 Door 228i, 4 Cyl Turbo, AT, Silver with Black Interior, 55,862 Miles. Great Sporty Car and Fun to Drive! Asking \$17,000. Call 434-441-6766.

2008 Honda Accord Sdn 172,300 Miles, 4 Door, 4 Cyl, 5 Speed MT Combo, Silver with Grey Interior, 34 MPG HWY, Power Windows, Locks, Drivers Seat, Keyless Entry, Alloy Wheels. Drives Well. Asking \$5,800 OBO. Call 434-250-9847.

2002 Lincoln Continental 4 Door, 8 Cyl, AT, Pearl White with Beige Leather Interior, Sunroof, New Tires. 114K Miles. Asking \$4,000 OBO. Call 434-429-5305.

1992 Oldsmobile Cutlass Supreme V6, AT. Will sell whole car or for parts. Call 434-517-1087

1994 Oldsmobile Cutlass Ciera/Cruiser Extra clean, very good condition, 72k original miles. \$1500. Call 434-710-9789

2017 Toyota Prius 4 Cyl, AT, Seal Foam Light Green with Beige Interior, 35,165 Miles. Asking \$20,000. Call 434-793-4641.

2005 Nissan Altima 4 Door, 4 Cyl, AT, Silver with Black Interior, Only 103,200 Miles. Asking \$4,999. For More Details, Call 434-799-4610. VADLR

2013 Ford Fiesta 4 Door, 4 Cyl, MT, Plum with Gray/Black Interior, FWD, 38-41 MPG, 13K Miles on Tires, 1 Owner, Runs Great, Strong A/C, 129K Miles. Asking \$4,500. Call 540-488-2663.

2009 Hyundai Elantra 4 Door, 4 Cyl, AT, Blue with Grey Interior, 138,151 Miles. Asking \$4,000 OBO. Call 434-709-9024.

Auto Parts & Accessories

MICHELIN PILOT SPORT CUP 2-TIRES: 4-P305/30 ZR19. New Take Offs, 26 Miles. Track Tires Perfect for VIR. Asking \$1,200. Call 434-822-2126. (434) 822-2126

Parts for 1964 Oldsmobile Dynamic Front and back windshield, 4 Doors, hood, 394 head and block, 4 hub caps. Call for prices. 434-251-3890

King Crossword

ACROSS

- 1 Homer's cry
- 4 Commotion
- 7 Couturier Bill
- 12 — out a living
- 13 America's uncle
- 14 They're usually covered in white
- 15 Auto
- 16 Cartoon canary
- 18 Suitable
- 19 Point of view
- 20 Effervescence
- 22 Squirrel's home
- 23 Mediocre
- 27 Samovar
- 29 Sister of Venus
- 31 Kin of "Abra-cadabra!"
- 34 Crucifixes
- 35 Sufficient
- 37 "Brady Bunch" girl
- 38 Cash-drawer compartment
- 39 Swelled head
- 41 Marvel Comics group
- 45 Clutch
- 47 Anger
- 48 16-Across' pursuer
- 52 Legislation
- 53 Praiseful rendition
- 54 Clean Air Act org.

1	2	3	4	5	6	7	8	9	10	11	
12			13			14					
15			16			17					
18			19								
20			21		22			23	24	25	26
			27	28			29	30			
31	32	33					34				
35					36	37					
38				39	40			41	42	43	44
				45				46		47	
48	49	50	51							52	
53						54				55	
56						57				58	

- 55 Consumed
- 56 "Excavating for —"
- 57 Bashful
- 58 Neither partner
- 8 Myrna of Hollywood
- 9 Matterhorn, e.g.
- 10 Tackle moguls
- 11 Away from NNW
- 17 Reindeer kin
- 21 Boer fighters
- 23 Cheer-ful part of NYC?
- 24 Zodiac feline
- 25 Moreover
- 26 Owns
- 28 Tatter
- 30 Detergent brand
- 31 Dog's doc
- 32 Individual
- 33 Tiny particle
- 36 Towel word
- 37 Andrew Lloyd Webber title role
- 40 Microsoft big-wig
- 42 Where to see "The Last Supper"
- 43 Poets' Muse
- 44 More recent
- 45 Hackman or Wilder
- 46 Beseech
- 48 Masseur's workplace
- 49 Sweet potato
- 50 Mainlander's memento
- 51 U-Haul rental



HELP WANTED

REMEDICATION TECHNICIANS

Dependable individuals with experience in construction or demolition.

Must be willing to wear protective equipment.

For More Information Call 434-483-3189

Employment Help Wanted

Maintenance Helper Needed: Local rental property business needs helper to cut grass, clean up, paint, and minor repairs 3 to 6 days a week. Must have valid drivers license and good driving record. Must have own transportation and be able to pass a drug test. Starting pay \$12 to \$14 hr.. Call 434-792-8305 Monday thru Friday only and leave a message or send resume to Ellis Real Estate 619 Holbrook Ave. Danville, VA 24541. (434) 792-6603

Help Wanted! Part-Time to Full-Time, Must Have Painting and Carpentry Experience. Must Have Transportation. Call 434-251-1434.

Hiring experienced Auto Body Technicians Immediate opening for experienced automotive body technicians at Joe Hudson's Collision Center! Competitive pay, paid holidays, paid vacation, 401k, company matched insurance plan and paid I-car training. Apply in person or call 434-728-6770. All phone calls to this number are confidential. Let's talk today! (434) 728-6770

NOW HIRING PCA/CNAS Angel Wings Home Care is looking for caring, hard-working CNAS and PCAS! Day-time cases available in Danville and surrounding areas. Please call or come by today! (434) 836-8711

EMPLOYMENT OPPORTUNITY NEW, INCREASED WAGE RATES

Have you been looking for a job opportunity that offers flexible shift times, great benefits or to supplement your income? Consider driving for Danville Transit. The transit system's *new* starting wage rate for full and part-time drivers with a CDL is **\$15.11** per hour and **\$14.00** per hour for drivers without a CDL. Full and part-time driver's positions are presently available. For more information about how to apply for a driver's position, please contact the City of Danville Human Resource's office at (434) 799-5241.



Danville Transit System

Home Remodeling Experienced Help Needed Salary and benefits depending on experience!! Send Resumes to haymoregardencenter.com (434) 250-9853 haymore@haymoregardencenter.com

Remodeling Contractor Needs Part-Time Helper. Must have Car, License and Insurance. Must Pass Background and Drug Test. Call Joe at 434-250-4139.

Mobile Home Removal: Need a Demolished/Unlivable Mobile Home Completely Removed in the Pelham, NC Area. Call 336-388-9533.

Cabinet Shop Seeks Experienced Cabinet Makers and Helpers. Apply at Custom Wood Works, 1603 Halifax Road. Call 434-489-6991 for Appt.



Piedmont Shopper
In Print & Online
434.822.1111
www.piedmontshopper.com

Cook, Dietary Aide and Utility Worker

Career opportunity for individual with culinary skills. Must be able to complete job tasks on a timely basis and comprehend written information efficiently. Position requires performing variety of duties including preparing food items and beverages, serving on the trayline, and general cleaning. Preferably ServSafe Certified.

No wonder we're attracting and inspiring some of the area's top nursing professionals and staff.

Excellent pay and benefits including health, life, dental and 401(K) investment plan. Criminal history check and drug screening required. Please apply by contacting Human Resources via email at tweaver@romaneagle.org



ROMAN EAGLE
Rehabilitation & Health Care Center
www.romaneagle.org

RN's, LPN's and CNA's

Roman Eagle Rehabilitation & Health Care Center has Full Time 3-11 and Full Time 11-7 positions available for RN's, LPN's and CNA's, with a Hiring Bonus of \$500 for full-time and \$250 for part-time employees.

At Roman Eagle, we've always made caring the top priority and that means also caring about our employees. We offer competitive salary and benefits including health, dental, life insurance, paid holidays, vacation, sick pay and 401K. Apply with our Human Resources Office at 2526 N. Main St., Danville VA EOE



ROMAN EAGLE
Rehabilitation & Health Care Center
www.romaneagle.org



Class A CDL Driver Needed: Greenbriar Transport LLC, Locally Owned. We specialize in Portable Storage Building Delivery and Setup. Our Drivers are Home Every Night. Also, Guaranteed \$750 Weekly Salary, Plus Commission. EXCELLENT INCOME OPPORTUNITY! Immediate Opening. Please Call for an Application. Former Applicants Need Not Apply. 336-388-5063.

General Labor: Door Builder Needed for Manufacturing Company. Paid Training, Production Based Pay After Training. Apply in Person at: 1228 Carroll Road, Providence, NC 27315.

REEFER OWNER OPERATOR: RS Transport, Located in AXTON, VA. Dedicated Runs. Weekly Settlement. Direct Deposit. Call NOW: 540-632-3671

Regional CDL Class A Drivers: Driver Late Model and Clean Equipment. 2 Years of Experience, 23 Years Clean MVR and DOT. Home Weekends. Call 540-314-5556 or 540-632-3671.

See it...

Hear it... Say it...



Buy it...

Rent it...

Sell it...

Learn it...

List it...

Tell it...

Fetch it...

Smell it...

Trade it...

Hire it...

Get it!...

...in the **CLASSIFIEDS!**

Bumpers for Dodge Ram 1500 Call for price. 434-738-6554

Chevrolet Truck Rally Wheels: 8", Beauty Bands Included, No Centers. Asking \$300. Call 434-203-4538.

Set of Chevrolet Rims/Tires, for a 1992 Silverado. Aluminum Wheels. 50-60% Tread on Tires. Asking \$100 for All 4. Call 434-203-4538.

Used Tires for Sale 17-215-60. Decent shape. \$50 for all 4.

1992-1995 Thunderbird Tail Light: Passenger Side Trunk Mount with Emblem. Lights Up. In Good Condition. Asking \$50. Call 434-713-1877.

Looking to Buy 1964-1966 Chevy Truck Bench Seat, in Good Condition, at a Fair Price. Call 434-656-6563.



Honda Ridgeline Silver Side Steps Get in and out of your Ridgeline with ease and style. These 2014 tube-style silver side steps are made of lightweight aluminum, heat treated for superior strength and corrosion resistance—fit 2006 thru 2014 Ridgelines. Embossed step pad for traction, with the vehicle's logo for that custom feel. Honda Part #08L33-SJC-100E Owner has installation instructions and source for "rivnuts" for frame. Price new \$300+ (434) 822-0755 su_and_du@gamewood.net

4 Tires for Sale, Size 225/6517. Call for Price, 434-432-9122.

2 Michelin Harmony Tires, in Very Good Condition, with Very Good Tread Left. Size 225/60R17. Asking \$25. Call 434-797-5604.

55-57 Chevy 3 NOS: AC, GM, GF48 Gasoline Filter Housing, Glass Bowl and Element. 2 in Box, and 1 Out. Asking \$120. Call 434-822-1383.

NOS 55-57 Chevy AC GM: Gasoline Filter Element GF 124, New in Box. Asking \$30; AC-Delco Radiator Pressure Cap RC1-7lbs, Asking \$12. Call 434-822-1383.

'57 Chevy Wiper Motor: 12 Volt Electric. Asking \$100. Call 434-822-1383.

1970-81 Camaro Interior Parts: All Black and Original GM Parts; Dash Panels, Rear Side Panels, Kick Panels, Interior Trim and More. Call or Text 434-489-1252.

HR-78-15 Tire and Wheel: Reynolds 5-Hole Steel Wheel, 2" Offset (Needs Some Paint). Tubeless Tire: 6-Ply Tread (9/32" Tread Depth of 10 or 11/32 Original), 4-Ply Sidewalls, 1,770 lb. Max Load and has been Stored in Garage, so No Sun Damage. Perfect for your Trailer as a Running or Spare Tire. Call 434-713-4185.

Chevrolet Pickup Electric Outside Mirrors: 1 Left and 1 Right. Fits 2015 Chevrolet 2500 HD Pickup Truck. Brown in Color, Like New. Asking \$125. Call 434-203-2275.

Goose Neck Adapter for Sale: Good 2 Go Camo Goose Neck Adapter, 7,500lb Vertical Load, Like New. Paid \$530, Asking \$300. Call 434-203-2275.

94 OLDSMOBILE FOR PARTS: Rear Collision, 3.1 Motor and Trans. Runs Good, Trans Works Great. Must Take All. Asking \$400 Call 434-713-4091.

1972 Chevrolet C10 350 Motor 350 Motor. Factory air, new bumpers, new grill, new interior, new steering. Runs great. Primed and ready for paint. Call for price. 336-613-4961.

1982 Chevrolet Rear Bumper with trailer hitch. \$90. Call 336-613-4961

Tools for Sale 4 Way lug wrench's, tools boxes, tools and used tires. Cheap prices! Make an offer!! Call 336-514-8319

VA and NC License Plates: For More Information and Prices, Call 434-228-3121.

Auto SUVs

2003 Nissan Pathfinder 4WD 2003 Nissan Pathfinder. Runs and in good condition. Rear main seal leak. Asking \$3800 obo. Call or text 434-579-7944. (434) 579-7944

2003 Nissan Pathfinder 4WD 2003 Nissan Pathfinder. Runs and in good condition. Rear main seal leak. Asking \$3200 obo. Call or text 434-579-7944. (434) 579-7944

1998 S10 Chevrolet Truck 2 Door, 5 Speed, Nice Interior, Looks and Runs Good. No title. Asking \$1,800. Call 434-250-7743.

2018 Toyota Highlander LE: 23K Miles. Asking \$29,700. For More Information, Call 434-203-0190 or 434-251-4557.

2006 Honda Pilot EX 4x4: 154K Miles. Asking \$5,000 OBO. For More Information, Call 434-203-0190 or 434-251-4557.

2003 Lincoln Navigator, 200K Plus Miles. Motor and Transmission Good, Needs Minor Cosmetic Work and Possibly a Starter. Asking \$1,600 Firm. Call 903-519-1569.

2002 Ford Escape: 31K Miles, 1 Owner, Every Option Ford Offers, Black on Black, in Excellent Condition. Asking \$10,000. Call 540-890-3824.

2016 Jeep Patriot: Gray, AT, AC, 4 Door, 25K Miles. VADLR. 434-791-4000

2014 Nissan Pathfinder Platinum Edition: 75K Miles, 1 Owner, Garage Kept, Tires New in Jan 2019, Battery New in Jan 2020. All Electronics Work Properly. Asking \$14,900, Negotiable. Call Jason at 434-728-0909.

Auto Trucks

2011 Chevrolet Silverado: LOW MILES, Ext Cab, 59K Miles, PW, Remote Entry, Tow Pkg, Cruise, 2WD, White. Clean, Nice Truck. Asking \$15,500 OBO. Call 434-250-2432.

1990 Chevrolet Truck Long bed, 3.4 motor. Single Cab, 5 Speed, Looks and Runs Great. Asking \$1,800. Call 250-7743

2004 Chevrolet Truck Extended cab, new tires, rebuilt engine with 55k miles, 5cyl, 2 toned Burgundy, clean inside and out. Call for price. 434-250-8616 or 434-483-7035

Sleeper Tractor Trailer Intl Cab-Over Cummings, 400 BC, III Factory Recon Engine. Buy Complete or Parting out. \$6,000. Call 434-203-1723.

2003 Ford Ranger Super Cab: AT, AC, 4x4, V6, 176K Miles, Good Condition. Asking \$4,500 OBO. Call 434-710-0104.

2012 Chevrolet Silverado Crew Cab, in Excellent Condition. Asking \$10,500. For More Information, Call 434-728-9582.

What's Going on in Shopperland



Shopperland is Danville, Pittsylvania County, & Caswell County

Please email community news to: info@piedmontshopper.com

Jail-A-Thon Fundraiser

2019 Kiwanis Citizen of the Year Androniki "Niki" Fallis gets "jailed" during the Danville Kiwanis-Alpha Upsilon Lambda Professional Chapter fundraiser held July 30th at the James F. Ingram Justice Center. According to project coordinator and President-elect John Wilt, the Jail-A-Thon event raised \$2,060.00 which will be used to support Kiwanis special projects and youth programs.



NEED A NEW ROOF?
 Call **DICKENS & SONS**
 today at **434-251-2968**
 Over 30 Years Experience • Locally Owned & Operated
 Residential & Commercial Roofing
 Military & First Responder Discount Available
 Licensed | Bonded | Insured
 Dickie Dickens, Owner

\$1 Million Investment Enhances Early Childhood Education at DCC, State

Danville, Va., August 12, 2020 — The Davenport Institute, a three-year, \$1 million grant program at Danville Community College (DCC), concluded this summer on July 31. A total of 174 students completed the program during that time, with 35 graduates coming directly from DCC.

"I am so proud of what the Davenport Institute has accomplished," said Traci Daniel, DCC assistant professor and director of early childhood education. "It has been amazing to see all the support and excitement from everyone involved: Students, providers, stakeholders, community members, and college faculty and staff. A major goal of this program was to increase the quality of care our young children receive and I do believe that was definitely achieved. Students in the program received access to the community college, one-on-one mentoring, direct classroom support, and knowledge to improve their practice. I am excited to see what else is in store for early childhood locally and at the state level."

The Davenport Institute for Early Childhood Development was created in partnership with Virginia's Community Colleges (VCCS) and The Virginia Foundation for Community College Education.



Pictured, from left, are Davenport Institute Director Kim Gregory, Chief School Readiness Officer Jenna Conway, Danville Community College Davenport Fellow Pamela Bucchi, and DCC Assistant Professor of Early Childhood Education Traci Daniel at the annual Virginia Association for the Education of Young Children (VA-AEYC) Conference in early March 2020

Riverside Cleaners is saying...
Thanks to Our Community's
HEALTHCARE PROFESSIONALS
 All Cleaning/Sanitizing Services on Scrubs are now **50% off per set!**
 We also provide laundry bags & **FREE** pickup and drop off service!!
 Take advantage of not having to take your scrubs home to your family by calling us today to set up service!
(434)203-9591
 Riverside Cleaners Locations
 Chatham on Main St. • 1370 Piney Forest Rd. Riverside Shopping Center (Beside Subway)
 434.792.9567

Marathon Man

With the August 2nd "Festival of Running" in Wilmington, DE cancelled, there was only one alternative for John Wilt: RUN VIRTUALLY! Southwyck Farms and several Danville city streets and Goodyear Blvd. served up a respectable marathon course for 26.2 miles on Sunday, August 2nd. You can see John's finishing time in the pic and ultimately DE is now wiped from his list of states! What you don't see in the pic is the temp on August 2nd: 92 degrees! Next marathon--#90--will be Billings, MT (35th state) on September 20th. John is hoping that Billings, MT in late September will be on the cool side!



1975 Ford F-600 Flatbed Dump Truck. In Excellent Condition, Shed Kept, Metal Sides and Tailgate. Call 252-814-7155 or 252-814-8451.

1982 Chevrolet Custom Deluxe Truck: 6 Cyl, 51K Miles on Motor and Truck. Never Been On Road. 3 on the Column. Needs Some Repairs. Runs Great. Asking \$2,000. Call 336-613-4961.

2016 Chevrolet Silverado Long Bed: 2WD, AT, AC. 11K Miles. Call for Price. VADLR. 434-791-4000

Wanted to Buy 2005-2014 Toyota Tacoma, 2 or 4WD, at a Reasonable Price. Call 434-579-8952

Wanted to Buy 1987-1996 Dodge Dakota Pick Up. 2 or 4 WD at Reasonable Price. Call 434-579-8952

Baby & Children Items

Children's VHS Movies, Asking \$3 Each. Call 434-836-3615.

Name Brand Girl's Clothing, Sizes XS and Small. For 14-16 Years Old. Good Variety, Like New. Call for Prices, 434-822-0684.

Nice Crib and Changing Table: Crib Comes With Mattress and Bumper. Been used Just a Few Times and is in Great Condition. Changing Table is Very Sturdy and Comes With Changing Pad. Asking \$70. Call 540-488-5507.

Playground Items For Sale Swing set, sliding board and merry go round. \$1350 Firm. Call 434-441-1364.

Boats

Boat, Motor and Trailer: 14' Boat, 9.9 Engine and Electric Engine, Trailer with New Tires. Depth Finder. Asking \$1,695. Call 434-685-3255.

2009 1448 G3 Jon Boat, with 2000 40HP Jet Drive. Asking \$6,000 OBO. Text 434-709-4296.

14' V Bottom Boat, 40 Mariner Drive on Trailer. Asking \$1,500. Call 434-724-2161.

Books

Over 200 Assorted Cook Books for sale. Will sell individually or all for \$50. Call 434-709-1106

Danville Public Library: Bargain BOOK SALES have Returned! The FRIENDS Sale Area is Now Located on the Main Floor at the Front of the Library. Books and Media Items are Available by Category for Easy Shopping. Prices Remain \$1 or Less. Many Donated Books Available. Sales Support Numerous Library Literacy Projects.

Building Supplies

BLACK METAL PIPE NO RUST 3", 2.5" Bk Pipes 12ft, 2-6x6-9ft I beams. 2" angle iron, 6"9ft channel iron, Van ladder racks \$100. call/text 434-770-8102 (434) 770-8102

50 12" Cinderblocks \$2 each. Call 434-421-2233

OBITUARIES

"For whether we live, we live unto the Lord; and whether we die, we die unto the Lord: whether we live therefore, or die, we are the Lord's." - Romans 14:8

Arthur D. Mullins

July 21, 1925 ~ August 15, 2020 (age 95)



Mr. Arthur D. Mullins, age 95, of Danville, VA, went to his heavenly home on Saturday, August 15, 2020, at SOVAH Health in Danville.

Mr. Mullins was born in Jewell Ridge, VA on July 21, 1925, to the late Edward Mullins and

Nancy Van Dyke Mullins. He had worked as an IRS agent before his retirement. He served his country in the United States Army and received a Purple Heart and a Bronze Star. He was a member of North Main Baptist Church and also a member of the Roanoke Masonic Lodge. He was married to Nancy Damron Mullins who predeceased him.

Mr. Mullins is survived by his daughter, Katrina Searcey; grandchildren, Christine and Brandon Searcey; great-grandchildren, Ella and Gavin Searcey, and sisters, Helen Blevins and Rita Chambers. In addition to his wife and parents, he was predeceased by two children, Arthur D. Mullins, Jr. and Benita Mullins; his sisters, Carol Ann Davis and Kathleen Casey; and his brother, Herman Mullins.

Funeral services for Mr. Mullins will be held at 2:00 P.M. on Saturday, August 22, 2020 at Barker Funeral Home with the Rev. Daryl Joyce officiating. Interment will follow in Highland Burial Park with military honors conducted by the US Army. The family will receive friends at Barker Funeral Home on Friday, August 21, 2020 from 6:00 until 7:00 P.M. At other times, the family will be at the residence, 414 Brentwood Drive, Danville, VA, 24540.

Barker Funeral Home is respectfully serving the Mullins family.

Frances J. Warren

August 28, 1930 ~ August 15, 2020 (age 89)



Mrs. Frances J. Warren, age 89, of Danville went to meet her Lord and savior on Saturday, August 15, 2020 at Martinsville Health & Rehab Center. She was born in Danville on August 28, 1930 to the late Kersey Cockran and Annie Maude Cockran. Before her retirement,

Mrs. Warren had worked as an inspector for Dan River, Inc. She was married to Robert L. Warren who predeceased her, and she was a member of Schoolfield Pentecostal Holiness Church. In addition to her husband and parents, she was predeceased by two sons, Larry Warren and Steve Warren, three brothers, and eight sisters. Left to cherish her memory is two sons, David Warren and Dennis Warren (Lynette); grandchildren, Dennis Warren, Jr., Andrew Warren and Angela Musick; and great-grandchildren, Kayla Musick and Michelle Musick.

Graveside services for Mrs. Warren will be held at 2:00 p.m. on Thursday, August 21, 2020 at Danville Memorial Gardens with Dr. Charles Scarce officiating.

Barker Funeral Home is respectfully serving the Warren family.

Bobbie Eugene Mitchell



Mitchell Stewart.

Bobbie Eugene Mitchell, 88, of Danville went to his Heavenly Home on Friday, August 14, 2020.

Bobbie was born in Danville, on April 17, 1932 a son of the late John Willie Mitchell and Rosa Canupp

Bobbie served in the US Army during the Korean Conflict and was the owner operator of Danville Wrought Iron and Steel Company. He was a member of Third Avenue Congregational Christian Church for over 50 years where he served as a deacon and a member of the choir.

On April 25, 1958, he married the love of his life, Betty Niday Mitchell, who survives.

Survivors also include a son, Kevin Mitchell (Shawna), a daughter, Kim M. Sakellaris, a brother, Russell Mitchell, a sister, Naomi Marshall, eight grandchildren, Kasey (Joe), Emily (Jeff), Kelsey (Tony), Caitlyn, Patrick, Sean, Jordan, Arianna, two-great-grandchildren, Delanie and Dawson. He is also survived by a special daughter-in-law, Jeanne Mitchell, a special son-in-law, Harry Sakellaris, a special friend, Penny Bailey, and a special niece, Lori France, and a number of nieces and nephews.

In addition to his parents he was predeceased by three brothers, Homer, John, and Ronnie Mitchell and a sister, Shirley Von Eime.

A memorial service will be held on Thursday, August 27, 2020 at 6:00 PM at the Wrenn-Yeatts Westover Chapel conducted by the Rev. Frederick J. Vicks and the Rev. Shevi Sloane.

In lieu of flowers, the family suggests that memorial donations be made to God's Pit Crew 2499 North Main St Danville, VA 24540.

Wrenn-Yeatts Westover Chapel is serving the Mitchell family.



Remembrances and Obituaries From
The Piedmont Shopper
\$75.00

434.822.1800
www.piedmontshopper.com
Email: info@piedmontshopper.com

These free obituaries are sponsored by Swicegood-Barker Funeral Services as a service to their clients/families and Piedmont Shopper readers. Please let them know we appreciate their continued support.



Swicegood-Barker
Funeral Services
Swicegood Funeral Home (434) 792-5611
Barker Funeral Home (434) 792-7211
www.swicegood-barker.com

Janice Compton Hardy



It is with broken hearts and profound sorrow that we say goodbye to Janice Compton Hardy, age 66, of Chatham, VA, who went to be with her Lord and Savior on Tuesday, August 11, 2020, after a

courageous battle with ALS. Mrs. Hardy was born on June 24, 1954, to the late Grover and Essie Compton and grew up in Danville, VA. She was predeceased by her brother, Jerome Compton and her sister, Jeanne Hall, and her grandson Lucas Francis.

Janice was married to the love of her life, Irving "Red" Hardy, who survives. In addition to her husband, those left to cherish her memory are her children, Jennifer, Robert (Gracie) and Tim Francis, Alyson Brown (Ryan), Ashley Cline (Joey) and Adam Hardy, step-daughters, Robyn and Maria Hardy, 10 grandchildren, and her forever friends, Joy Marshall and Bettie Collins.

Mrs. Hardy was a homemaker and caregiver to all she met in need. She took pride in her family, her home and her home cooking. Her gracious, giving spirit will truly be missed by everyone she touched and loved, especially by her family and her friends. Mrs. Hardy loved God and was a Christian. She attended Tree of Life Ministries prior to her declining health.

Funeral services will be held at 2:00PM on Friday, August 14, 2020, at Norris Funeral Services' Mt Hermon Chapel with Pastor Greg Cobbs officiating. Interment will follow at the Hardy Family Cemetery, 2388 Green Pond Rd., Chatham, VA. There will be a Celebration of Life following the services. Online condolences may be made at www.norrisfuneral.com.

Business Opportunities

Regional CDL Class A Drivers Late Model and Clean Equipment. 2 Years of Experience, 23 Years Clean MVR and DOT. Home Weekends. Call 540-632-3671

Business Services

Adult/Child Care Services

Offering Private In Home Sitting: 15 Years Experience, Excellent References, Have Taken CNA Classes. Offering Weekend Hours Only. Call 434-483-8692

Home Improvement

Power Washing: At BPW Power Washing, we can basically make just about everything Shine and Look New Again! Please Give Us A Call at 434-728-5364. (434) 728-5364



Miracle Home Improvements *ROOM ADDITIONS *Garages *Screen Rooms *Replacement Doors *Storm Doors *Decks *Vinyl Porch Rails *Garage Doors *Basement Conversions CALL ON US FOR YOUR NEXT PROJECT! Licensed, Insured & Serving Danville & Piittsylvania Co. for over 25 Years (434) 724-2173

BATHROOMS REMODEL

Is your BATHROOM old & ugly? Loose TILES? TUB stained? Floor coming up? TOILET leaking? How would you like a Brand-New BATHROOM? We can install a new TUB or SHOWER, And new fixtures in no time at all!!! Call RICH for a FREE ESTIMATE. (434) 724-1026

Comfort Cooling Heating & Air {Service} {System Changouts} (New Installations) {Free Estimates} Where Quality Matters, Licensed and Insured. Financing Available. Call 434-791-2051 or 434-250-8530.

Old Fashioned Construction Replacement Windows, Decks, Remodeling, Painting, Doors, Tile, Flooring, Pressure Washing. 33 Years Hand On. Excellent References. Call Tim White at 434-334-4878.



ROOFS ANY TYPE: ANY ROOF, Asphalt, Metal, Wood. We do them all! Skylights and Fix Leaks, too. We Beat most Estimates. JUST CALL CHUCK, 434-483-7055.

Denture EXPRESS
 Dentures • Partials • Extractions • All Done on Site
1.888.806.0467 • 276.632.1565
 5 Dudley Street, Martinsville, VA



Dentures and Partials STARTING AT \$495⁰⁰
Upper & Lower Full Set \$990⁰⁰

GEORGE A. STERMER, JR. • DDS
CHRISTOPHER ALLAMAN • DDS
 An Affordable, Quality, Full Service Dental Practice
 Accepting New Patients! Please call today to make an appointment
276.638.3265
 We Accept Wells Fargo, CareCredit and Citi Health



Pincrest Assisted Living
 434-685-1620

Providing Love & Care for YOU or your LOVED one!
More than 30 years of Assisted Care Experience!
 Comprehensive Care in an Assisted Living Facility

709 River Ridge Road, Danville VA
434-685-1620 • 434-728-0597

Furr's Heating and Air Electrical & Plumbing

"We install the best, and service the rest."

Over 40 Years Experience!
 Licensed, Bonded, & Insured
 *Financing Available

434-728-0597

BBB Accredited Business
 10% Senior Discount on Labor!

MasterCard VISA DISCOVER

Danville Memorial Gardens: 1 Burial Plot, Located in the Garden of Rest. Asking \$2,500. For More Information, Call 440-759-1994.

Collectibles

WENDELL SCOTT DANVILLE NATIVE SET: Uncut Sheet Set; Danville Native Hall of Famer 30 Card RACE SET, Asking \$25. Call 434-713-0988.

Computers, Games & Systems

Wireless stereo headphones \$35.00 Brand new, never used. (276) 618-1829 cecat4904@yahoo.com

Farm Equipment

1952 30 Ferguson Tractor: delivered New Battery, Tires, Fuel System, Tune Up, and Excellent Paint. Asking \$3,200. Delivered with a cover. (434) 251-8317 wstarkey17@yahoo.com

Farm Tractor Implements: 3 Pt, 5' Disc, Asking \$275; Ford 3 Pt 2 Bottom Plow with Disc on Rear. Asking \$175. Call 434-203-1723.

Hay for Sale! MIX Hay-Clover, Orchard, Timothy, Fescue. Kept in Barn on Pallets, No Rain! Great for Horses. Asking \$45. Call 434-251-8787

Hay for Sale: Shed Kept. Asking \$30 a Roll. Call 252-814-8451.

Slabs for Sale: Asking \$25 for Pickup Load. Call 252-814-8451.

Portable Grain Bin: Call for Price, 434-710-8779.

Livestock Trailer: Call for Price, 434-710-8779.

International Farmall 140: Includes Front Riser Box. Call for Price, 434-710-8779.

Looking to Buy a Good Manifold and Radiator for a TO-20 Ferguson Tractor. Call 434-250-3730.

Wanting to Buy: Service Station and Farm Gas Pumps. Call 434-728-2960.

550 Heston Round Baler, Asking \$3,900. Call 434-770-8322.

Quality Hay: Grass or Oat Horse Hay 4x5 Rolls, Horse Tested, Horse Approved. Guaranteed! Asking \$45. Call 434-250-5063.

HONEYBEE STARTER HIVES (NUCS): To Get Started in Beekeeping, Call or Text Old Dan at 434-770-8102. Help Save the BEES!

Ford Tractor Front Wheels for 9N or 2N Ford Tractor. Tire Size 4 x 19; Will Not Fit 8N. Asking \$100. Call 434-386-7777.

Looking for Hunting Land: Looking for Hunting Land to Lease, in Pittsylvania County, for 2020 to May 31, 2021. Please Call 434-429-4195.

285 Massy Ferguson: Needs Radiator Repair. Asking \$3,000. Call 434-770-8322.

Fitness, Exercise, Sport

Pedego Interceptor Classic Electric Bike: 26" with Pedal Assist. Needs New Battery. Asking \$500 OBO. Call 434-799-6272.

Schwinn Unicycle, Barely Used. Asking \$100 OBO. Call 434-799-6272.

Folding Bicycle, in New Condition. Asking \$170. Call 434-203-2840.

Exercise Bike for Sale, Older Model. Call for Price, 434-728-2046.

Pro Form Crosswalk 405 Treadmill, Like New. Asking \$150. Call 434-797-9307.

Treadmill for Sale, Like New. Asking \$100. Call 336-613-4961.

Women's Roadmaster Mountain Climber, 26" 10 Speed, Purple. Asking \$65. Call 434-548-8206.

Women's Roadmaster Mountain Sport Bicycle, 26", 18 Speed Twist Shifters, with Shocks. Asking \$90. Call 434-548-8206.

Girls 20" Mountain Bike: Roadmaster 20" Girl's 18 Speed Bike. Asking \$60. Call 434-835-0215.

Diamondback Mountain Bike: 20" Diamondback Response XE. 26" Tires Plus Extra Set. Bike Hitch. Asking \$125; Plus, Hanging Bike Rack, Asking \$50. Call 434-710-0052.

Schwinn Hybrid Mountain Bike 26" Highplane. \$100. Call 434-489-4529

Furniture & Accessories

Vintage Metal Kitchen Tables. 2 Gray tables, one with 6 chairs and one with 6 chairs and leaves. 1 metal yellow table with 1 leaf. \$300 for all. Call 434-489-3915

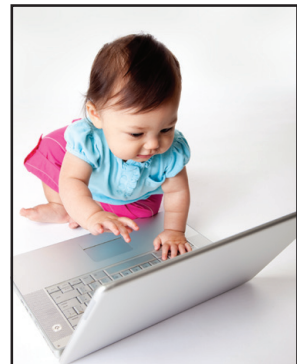

Piedmont Shopper
 In Print & Online
434.822.1111
 www.piedmontshopper.com

State Farm

13995 U S Highway 29, Suite 700
 Chatham, VA 24531

Bus 434.432.5461 Fax 434.432.8159

todd@toddbreaux.com
 toddbreaux.com • Find us on Facebook
 http://www.facebook.com/pages/Todd-Breaux-State-Farm-Agent



Todd Breaux, Agent



Bookcase with Bottom Drawers: Call for Price, 434-728-2046.

4 Piece Wrought Iron Porch Set. Call for Price, 434-728-2046.

Desk Chair on Wheels, in Good Condition. Asking \$7. Call 434-797-9307.

Matching Sofa and Chair: Asking \$250 for Sofa, and Asking \$100 for Chair. Call 434-822-0684.

Antique Wardrobe: Dresser with Large Mirror, and 8 Drawers. Call for Price, 434-483-3014.

Pine Wood Hutch, 76" H x 17.5" D x 51 1/4" W. 3 Drawers. Walnut Color Stain. Asking \$375. Pictures Upon Request. Call 434-250-1942.

2 Small Wrought Iron Chairs, Ice Cream Type, with Padded Seats. Asking \$15 for Both. Call 336-388-0505.

4 School Desks for Sale: 2 Big and 2 Small, in Good Shape. Call for Prices, 434-822-5516.

Solid Wood 5 Piece bedroom set. Call for more information. \$650. Call 434-441-1364

Hutch/Microwave Cart: 72" High x 43" Long. In Excellent Condition. Smoke Free Home. Asking \$100 OBO. Call 434-753-2305.

Health & Beauty

Beautiful hair \$20 has been shampoo'd and set. Was worn twice or three times. Light brown with slight highlights (434) 770-1109 brucepaline@yahoo.com

Wolf Suntan Bed, Model CSP7, In Excellent Condition. Asking \$500. Contact: junematherly@gmail.com

All Home Services
 Call 434-483-7055

ALL HOME SERVICES: Additions, Renovations, Roofing, Painting, Doors, Windows, Finish Basements, Decks. Just Call Chuck, 434-483-7055.

B & W Home Improvements LLC: Licensed, Bonded and Insured. 20 Years of Experience. Roofing, Seamless Gutters, Decks, Bathroom Remodeling, Painting, Replacement Windows, Landscaping, Power Washing, Tree Work and Much More! Caleb Basham, Owner and Operator. For Free Estimates, Call 434-228-2512.

EZ JOB CONCRETE LLC: Driveways, Sidewalks, Slabs, Poured Walls and Anything involving Concrete. Quality Work. Calls, Texts or Messages will be returned by Andrew Tickle. 434-548-5869

Lawncare

R&D Tree Service, Inc Professional Tree Care. Over 35 Years Experience. Proof of insurance, BBB Accredited Business. Full Service Tree Care Company with Largest Stump Grinder in Area. Call 434-822-6010.



A1 Lawncare LLC
434 334 8026

A1 Lawncare LLC: Residential and Commercial Lawn Care and Property Maintenance: Mowing, Property Cleaning, Tree and Brush Cutting and Clearing, and Outside Water and Property Issues. Free Estimates! 434-334-8026.

Gibbs Lawncare and Landscaping: Offering Mowing, Trimming, Shrub Trimming, Mulching, Clean Ups, Pressure Washing and More. Call Gibbs at 434-250-1686.

Tony Ray Cook Tree Service with Bucket Truck, Stump Grinding, Backhoe Service and Bobcat Work. Free Estimates! Call 434-489-2886 or 434-793-3665.

Billy's Stump Grinding LLC: Stump Grinding, Brush Removal, and Bobcat Work. Licensed and Insured. Free Estimates! Call 434-334-9347 or 336-514-2746.

Miscellaneous



Henderson's Cleaning Service: Licensed, Bonded and Insured. Serving Danville and Surrounding Areas. Regular Routine Cleaning: Weekly, Bi-Weekly and Monthly. Residential, Commercial and Small Business Services. Move-In, Move-Out, Organizing, Spring, Holiday and Deep Cleaning, and Carpet Cleaning. We also offer Painting, Pressure Washing, Disinfecting Services and General Home Repairs. References Available. Call Lena Today for a FREE Estimate! 804-878-9672. Check out our Website @ www.Hendersonscleaning.com

Sitter for Alzheimer's and Elderly: 15 Years of Experience, Excellent References. 1st, 2nd, and 3rd Shift. Please Call 434-709-4714.



Concrete Slabs/Sidewalks/Driveways: We Can Do Any Concrete Work. 10' x 20' x 4", \$1,000 (Concrete, and Labor). Free Estimate. Call 434-203-5443.

Bald Buffers LLC: Intense Floor Cleaning: Hardwood, Laminate, Linoleum, Stripping and Waxing; Tile and Grout Cleaning; Free Estimates. Bald Shine is the Best Shine! Call 434-835-2809 or baldbuffersllc@gmail.com

Cemetery Plots

Cemetery Plots \$13500, Danville Memorial Gardens, Garden of Devotions, 2 plots 34 Lot 323 1 and 2, 2 vaults, and a companion marker. (803) 760-8093 franbarr48@gmail.com

Oak Ridge Cemetery, South Boston: 3 Burial Plots, Located in Section 3. Asking \$3,000. Call 434-250-8543.

Please Join Us in Welcoming Three New Providers to the PATHS Family!



Elizabeth Harris, ANP-BC
 Danville Office
 Now Accepting New Patients!

Carley Shelton, FNP-C
 Martinsville Office
 Now Accepting New Patients!

Dr. Pottinger (OB/GYN) - Danville Office
 Accepting New Patients
 Beginning October 1st

Danville Adult Medical - 434-791-4122
Danville Pharmacy - 434-791-4880
Chatham - 434-432-4443 • South Boston - 434-575-1336
Martinsville Medical - 276-632-2966 • Martinsville Pharmacy - 276-670-2207

Find us on Facebook

PATHS
 Live Life. Be Healthy.
 www.pathsinc.org





Shop Our Ever-changing Inventory that includes recently added local artist items, painted furniture & much more!!



100 Commerce Street Danville Va. (just off Riverside Drive) • Tuesday - Saturday 10am - 5pm
434-549-5980 • www.marketonthedan.com • Follow Us on Facebook!

Holiday Items

Used Quart Size Canning Jars, Regular Mouth. Large Quantity. Call for Prices, 336-388-5089.

Household Items

Valspar Stain for Decks and fences. 5 gallons of honey gold color. \$20 each. Call 434-797-1914

Queen Size Comforter Set: Reversible Paris Theme and Black and White. 3 Pillows and 2 Shams. Asking \$35. Call 434-835-0215.

Oneida Porcelain Dishes, "Cherry Valley", 45 Pieces. For More Information and Price, Call 434-548-2978.

4 Pair of White Plantation Blinds: 2", 34 x 64. Purchased at Lowes. Asking \$35 a Piece. Call 434-836-2149 or 434-713-5179.

Lamps for Sale, Asking \$15 Each. Also, Many Household Items for Sale. Call 434-822-0684.

Rainbow Vacuum Cleaners, Good Prices. Call 434-203-3060.

Hitachi Bread Maker, Like New. Has All Books. Asking \$25. Call 434-835-0215.

Brown Hulled Out Dishes Call for price and more details. 434-770-2502

LG 55" Flat Screen TV HD. Call for price and more details. 434-489-4529

King Size Bedding Set: Includes Comforter and Sheets. Asking \$15. Call 434-822-0884.

Mama's ATTIC THRIFT STORE

Nancy Davis
Derek Davis

1066 Riverside Dr.
Danville, Va 24540

434-250-4724
<https://www.facebook.com/mamasatticthriftstore/>



New Inventory Arriving Daily
SPRING/SUMMER HOURS
Tues. - Sat. 10am - 5pm



Health/Medical Supplies

Used Wheelchair, Very Nice. Not Too Heavy, and Foldable. Asking \$75. Call 434-203-1271.

Drive Medical 3 Position Geri Chair Recliner. Only Used Once. Paid Over \$400, Asking \$200. Call 434-432-1413.

Upright Walker, in Good Condition. Reasonably Priced. Call 434-432-0881.

Hoveround for Sale: Call for Price, 434-770-2502.

Disposable Bed Liners, 15 Count. Asking \$3. Call 336-694-3523.

Men's Assurance Underwear, Size Small-Med. 19 Total. Asking \$3. Located in the Mt. Hermon Area. Call 434-728-7700.

Heating & A/C Equipment

Cut All You Want!! Poplar Wood. Located in Danville. You Must Haul. Call 434-489-2652.

Electric Furnace for Mobile Home: Works Good. Asking \$200. Call 434-713-4952.

Complete Central Heat & A/C: 5 Ton Dual Fuel Furnace, Coil, Outdoor Heat Pump and Thermostat. About 15 Years Old. Works Great. Still Installed. Can See Operating. Comfortmaker Brand 13 Seer. Setup for Propane; Could be Converted. Asking \$1,650. Call 434-250-6576.

Fisher Grandma Bear Wood Stove: Double Doors and 8" Rear Flue. Asking \$750. Call 434-251-3375.

Hobby Circle

Singer Slant O Matic 500 sewing machine in cabinet with attachments and instruction book. Has been recently serviced and is in good working condition. Asking \$150. Call 434-797-1425 or 434-489-3915

Telescope on Tripod: 6 Lenses, with Information Book, All Like New. Asking \$40 OBO, Cash Only. Pictures by Request. Call 434-250-1942.

HOME GROWN.

URW Community Federal Credit Union has been serving the people of Danville for 50 years. No one understands the needs of the local community, our community, better than us. And our goal today is the same as it was when we opened our doors five decades ago: to provide you with the very best financial services. Thank you, for supporting us over the last 50 years. As always, we're working for you!



URW
Community Federal Credit Union



Is your bank lobby closed?

If your financial institution isn't helping you, maybe it's time to experience the URW difference!



1092 NC Hwy., 86 Yanceyville
314 Lowes Drive, Danville, VA
539 Arnett Blvd, Danville, VA
142 South Main Street, Danville, VA (SOVAH)
13701 US Hwy 29, Suite 1, Chatham, VA 24531
4018 Halifax Road, South Boston, VA 24592
796 Commonwealth Blvd., Martinsville VA
www.urwfcu.org • 434.793.1278

See Us On Facebook

LATE Summer SAVINGS

Prices good through August 26, 2020

Fresh Chicken Tenders \$1.99 lb.

Boar's Head Naturally Smoked Bacon \$5.99 16 oz.

Fresh Baked Potatoes lb. 69¢

Washington Red or Golden Delicious Apples 3 lb bag \$2.69

Black Canyon Angus Cubed Steaks \$3.99 lb.

Fresh Ground Chuck lb. \$2.99

Daisy Sour Cream 8 oz. 99¢

LOCALLY-GROWN White Corn

Danville's Own PJ's Cakes & Pies
Hall's Pastry Shop Oatmeal Cookies
Martinsville, VA Rising Sun Breads
Homestead Creamery Milk & Ice Creams

MIDTOWN MARKET
7 Chambers Street • Danville, Virginia
434.793.8211 • Mon.-Sat. 9 am - 6 pm

VIRGINIA GROWN



FARMERS MARKET

PITTSYLVANIA COUNTY

FRIDAYS 4 - 6:30PM • SATURDAYS 7:30 - NOON

For more info call:
434-432-8026

Olde Dominion Agricultural Complex
19783 US Hwy 29 S. • Chatham VA



Mobile Homes
1 Acre Lots for Rent and Homes for Rent or Sale. Rolling Hills Mobile Home Park. Owner Financing Available for Homes. Call 336-207-0998.

Real Estate
Land For Sale Kentuck Church Rd. Ringgold Va. 16.9 wooded acres. 173ft. road frontage. Call 434-203-4176

Home For Sale Kentuck Church Road, Ringgold Va. 3BR/2BA. Nice cleared lot. 2 fireplaces. Full basement. Call 434-203-4176.



2 Bedroom Apt North Side \$450 Rental Special! 1st Floor Apartment in quiet secured building. Refrigerator and stove included. New windows to be installed before year out. Don't miss this one! Applications now being accepted. Call 4347974663. (434) 288-0884 eaglemg-mtco@gmail.com

Building Lot for Sale: 100' Road Frontage x 300' Deep. Has Electric, Septic and Well. Located at 2061 Water Oak Rd, Callands. Asking \$18,200. Call 434-724-6862.

Starter Home: 3 BR, 1 Bath, 4.26 Acres, Detached 2 Car Garage. Located in the Tunstall District. Asking \$89,900. Call 434-792-4643.

Adult Male Looking for Lot with Water, Septic and Electric. Call 434-432-2766.



REGIONS PREMIERE MODULAR OUTLET OFFERING QUALITY 2 STORY, CAPE COD AND RANCH HOMES ON DISPLAY. CUSTOMIZATION IS OUR SPECIALTY. REPRESENTING CHAMPION, NATIONWIDE, AND HOLMES BUILDING SYSTEMS. OPEN HOUSE SUNDAYS 12 TO 5 www.americanshowcasemodulars.com CALL 855-835-0050 American Showcase Modulares

Double Wide For Sale: 3 BR, 2 Bath, Newly Remodeled. Front Deck, Large Covered Rear Deck, Single Car Garage, Refrigerator, Range and Microwave Furnished. Washer and Dryer Hookup. Large Storage Shed. Located at 3500 Wyatt Farm Rd, Axton. Asking \$84,000. Call 434-724-6862.

GARAGE for RENT

220 Riverside Dr. • Danville Va.
 \$550 Per Month
 1 - 10x10 Garage Door and Entrance Door
 Call 276-226-0108

.88 Lot in Desirable Neighborhood: Build your Dream Home off Golf Club Rd, in Laurel Woods subdivision. Twin Springs/Tunstall School District! Asking \$24,000. Call 434-857-8832.

Commercial Rental Properties: 2 Sites Available on Main St. in Gretna, Va. 1 Small Space, 240 Sq Ft, and 1 Large Space, 772 Sq Ft. For More Information, Call 434-713-4047.

Rental Property

304 Roberts St, Danville: 2 BR Apartment, 1 Bath, Refrigerator and Stove Included. Tenants Responsible for Utilities, Located Near Langston. \$375 a Month. Call 703-851-6786.

Taking Applications for 1 and 2 BR Apartments, Apply at Hauser Realty 220 Old Greensboro Rd. 9:00AM-5:00PM, Monday-Friday. Call 434-791-2521.

2016 Mobile Homes For Rent: Move in Ready! 2016 Mobile Homes for Rent, in an Established Mobile Home Park. Fully Finished, including Stoves, Refrigerator and Microwaves. Water, Sewage and Trash Removal Provided by Owner. Unit 1 has: 2 BR, 1 Bath. Unit 2 has: 3 BR, 2 Bath. Deposit Required. All Units have Carports. Call 434-250-2468.

2 Bedroom Home For Rent Located on Holland Rd in N.C. Newly remodeled. \$400 per month. cAll 434-251-4494



Quaint 2 BR Home: 2 BR, 1 Bath, New Roof, Vinyl Windows, Hardwood Floors, Private Backyard with Parking. Located on Hamlin Ave, Danville. \$500 a Month. Possible Rent to Own. Call 434-421-4053

Mobile Homes: Rent To Own 58E of Danville, Located on Milton Hwy. Pay \$80 a Week and Own Your Mobile Home. No Pets. Call 434-251-3545.

PUBLIC NOTICE

The Danville Redevelopment and Housing Authority will reopen its low-income public housing waiting list for 1, 2, 3, 4, and 5 bedroom apartments located at Cardinal Village, Cedar Terrace, Ingram Heights, and Pleasant View effective August 17, 2020. Rent is based on income. Applications are available on line at danville.housingmanager.com or via the link on DRHA's website, www.drhava.com.

If you have any questions, please contact one of our site offices via phone or email. Due to COVID, our offices are closed to the public.

Cardinal Village, (434) 793-1222, cchapman@drhava.com or carla.harrison@drhava.com
 Cedar Terrace, (434) 793-2516, mjharris@drhava.com or kkelley@drhava.com
 Ingram Heights, (434) 792-0303, aknight@drhava.com or triggins@drhava.com
 Pleasant View, (434) 792-0328, aknight@drhava.com or triggins@drhava.com

NO WALK-INS WILL BE ACCEPTED



EFFICIENT CONSTRUCTION & WATERPROOFING

Do You Have a Damp, Leaky Basement or Crawlspace? Call for your FREE Estimate!

Justin Goodman
 Owner
 434.792.7732

TUFF-N-DRI
 DRY BASEMENTS

We Accept All Major Credit Cards

2 Drip Coffee Pots: 1 Large Coffee Pot, Asking \$10; 1 Small Coffee Pot, Asking \$5. Call 434-822-0884.

5 Florescent Light Fixtures, in Fair Condition. Asking \$80 for All, Negotiable. Call or Text 434-429-1633.

Lawn & Garden

Craftsman Riding Mower Rear Tires on Wheels, Size 23 x 10 x 8. Asking \$30. Call 434-685-5310.

Looking To Buy Mower Would like to buy walk behind 5-8 HP sickle bar mower. Call 276-650-1864

Trees For Sale 3 Poplar Trees. 1 Sweet Gum. Make an offer. Call 336-514-8319

Looking to Buy a Murray 42" Cut, 6 Speed Lawn Mower, Running or Not. Call 434-799-4275.

Craftsman Self Propelled Push Mower, and Weed Eaters. Call for Prices, 434-250-3128.

Riding Lawn Mowers, and Lawn Mower Parts. Call for Prices, 434-250-3128.

2 Tillers for Sale: 1 Rear Tine, and 1 Pull Behind. Call for Prices, 434-250-3128.

Lawn Mower for Sale: Runs Great. Asking \$50, As Is. Call 336-613-4961.

WANTED: GAS LAWN-MOWER Need a Small Push Mower. On a Very Fixed Income. Please Call 434-770-4800.

In Need of Fill Dirt: Trying to Avoid Large Stones and Large Roots. Call BETWEEN 8:00AM-9:00PM, 434-250-6311.

Needing 3 Yards of ORGANIC MULCH or Composted Manure/Straw/Dirt Mix. Must be Reasonable and Delivered. May Buy More than Amount Listed. Call 434-228-5669.

NOS Lawn Mower Parts: 15 Boxes of Small Engine Lawn Mower Parts. Including 2 Oil Filters and 1 Piston Rod. Asking \$10. Call 434-797-5604.

Want to Buy Lawnmowers: Disabled or Broken Lawnmowers: Want to Buy 2-3 Push or Self-Propelled. Price Paid Depends on Condition. Call 434-489-1430.

22" Push Lawnmower: 4.5 B/S. Just Tuned! Light Wheels, New Blade. Looks Good, Easy Start, and Cuts Good. As Seen, Asking \$70. Call 434-489-1430.

Troy-Bilt 50" Zero Turn Mower: Pro-Model Black, Ultra Low 28 Hours, Like New. Easy to Use. Call for Price, 434-425-3871.

Huskavarna Leaf Blower 350 BT Backpack, Like New. Amazon Price, \$327, Asking \$200. Call 434-250-2401.

Craftsman Mower: 42" Industrial Cut, in Great Shape; Heavy Duty Cub Cadet; Push Mowers, in Excellent Condition. Call for Prices, 434-429-8436.

Cub Cadet Rear Tine Tiller, 6.5 HP, Used Very Little. Paid Almost \$1,000, Asking \$500. Call 434-710-0371.

John Deere Mower Deck, 54" with 3 Blades. Fits 530 Model. Excellent Shape. Purchased a Smaller Deck. Just Serviced Before Replacement. Asking \$600. Call 434-251-1340.

Parts for Riding Lawnmowers: Tires, Decks, Starters and Grass Catchers. All in Excellent Condition. For More Information and Prices, Call 434-429-8436.

Simplicity Deck 44, Complete. In Great Shape. Asking \$100. Call 434-713-4091.

Troy Built 21" Lawnmower Self propelled. Extra nice. \$125. Call 434-791-3215

HONEYBEE STARTER HIVES (NUCS): To Get Started in Bee Keeping, Call or Text Old Dan at 434-770-8102. HELP Save the BEES!

Livestock

Looking to Buy a Few Young Banty Hens and Rooster. Call 434-203-2840.

Square Bale Hay: Fescue and Fescue Lespedeza Mix Square Bale Hay. Baled This Spring. Call AFTER 3:00PM, 434-250-5530.

Miscellaneous

Canning Jars For Sale Pints, quarts, and half gallon. All clean and sterilized. In excellent condition. Call for more info. 434-797-1425 or 434-489-3915

2 Metal 50 Gallon Drums No dents, painted black on inside. \$30 each. Call 434-728-3881

Vintage T-SHIRTS: Ford, Harley-Davidson, Superman, Turkey, Horses, Wrestling, etc. Prices Vary. Call (434) 429-9781. (434) 429-9781 green6594@hotmail.com

Kohler Twin Motor 20 HP. \$75. Call 434-685-5310

Mirror & Lamp Cash Only Mahogany Mirror 46.5"x 30.5" \$45. Wrought Iron Adj. Floor Lamp. Ball at Base 56"H \$55. Pics by request. (434) 250-1942

Homemade Butterbean Sheller: Asking \$80. Call 434-724-6862.

Working From Home? Need Office Supplies like Paper, Bins, Folders, Mats, Signholders, Binders, Electric Stapler, Etc.? Call for Prices, 434-441-3090. (434) 441-3090 di33sel@yahoo.com

Round Hay Bales: 4 x 5 MIX - Clover, Orchard, Timothy, Fescue. Kept in Barn on Pallets, No Rain! Sisel Wrap/750 lbs 434-579-5734.

Frigidifier Dehumidifier, Like New. Asking \$75. Call 434-770-1695.

Collectible Hot Wheels and Cases: Asking \$150 Firm. Call 434-822-3615.

Nascar and Jeff Gordan Items: Call for Prices, 434-432-2766.

Cigarette Loading Machine: Call for Price, 434-713-8249.

Police Scanner for Sale: Call for Price, 434-713-8249.

Air Compressor for Sale: Call for Price, 434-713-8249.

Quart Size Canning Jars, Asking \$.50 Each. Call 434-797-9307.

Upright Bissell Vacuum Cleaner, in Good Condition. Asking \$35. Call 336-627-7874.

Metal Wheelbarrow, with New Tire, in Excellent Condition. Asking \$25. Call 336-627-7874.

3 Ivory Warthog Tusks: Call for Prices, 434-432-8128.

4 Arno Bernard Custom Knives: 3 Ivory Handle, and 1 Kudu Bone. Call for Prices, 434-432-8128.

NEW 5500 WATT DUROSTAR GENERATOR Electric Start. Runs on Propane or Gasoline. 120.240V. Asking \$425 Firm. Call 434-709-0241.

Large 5 Arm Chandelier, Nickel Finish. Asking \$85. Call 434-429-0786.

1960's Crystal Chandelier, Asking \$200. Call 434-429-0786.

Canning Jars for Sale: Pints and Quarts. Asking \$3 a Dozen, or \$10 for 4 Dozen. Call 336-388-0505.

Hitachi Bread Maker, Like New. Has All Books. Asking \$25. Call 434-835-0215.

Flea Market/Yard Sale Items: Lots of Nice Things to Sell. 1 Price for Everything. Call 434-489-5927. Leave a Message if No Answer.

Sunrise Spas, Never Been Used or Hooked Up. Asking \$6,500. Contact: junematherly@gmail.com

Unusual Small Filing Cabinet: 30" High, Top Part for Charts and 6 Small Drawers. Asking \$20. Call 434-792-6462.

3 Frying Pans: 2 Small and 1 Large. Very Good Condition. Asking \$7 for All 4. Located in the Mt Hermon Area. Call 434-728-7700.

Bicycle Cable (New): Fits 21 Speed Mongoose. Asking \$15. Located in the Mt. Hermon Area. Call 434-728-7700.

Motorcycles, ATVs, Go Carts, 4x4s

2014 Harley Davidson Heritage Soft Tail. 11K Miles, Like New, Burgundy. Asking \$10,000 OBO. Call 321-303-5460. (321) 303-5460

2012 Adventure Scooter Call for more information and prices. 434-251-7351

Los Tres Maguayes
 Ph: 792-0601 • Fax: 792-1943
 2818 Riverside Dr.
 All ABC Permits
 Eat In or Take Out • Catering
 Mon-Thurs 11am-10pm
 Fri 11am-11pm
 Sat 11:30am-11pm
 Sun 11:30am-9pm

Restaurante Mexicano

WE ARE OPEN FOR DINE-IN OR TAKE OUT!!

Carry-out orders are also still available. Please call 792-0601 to place your order.

11am - 2:30pm Monday through Friday Lunch Special #1-6 only \$5.25 including drink!

Visit online at lostresmaguayes.com Find us on Facebook

2013 Dirt Bike for Sale
 Call for Price and more info. 434-251-7351

3 Piece Leather Saddle Bags for Harley Davidson. Call for Price, 434-836-3297, 434-724-1239 or 434-709-3709.

2005 Harley Davidson Sportster 1200 CC. For More Information, Call 434-836-3297, 434-724-1239 or 434-709-3709.

Motorcycle Helmets for Sale: For More Information, Call 434-483-3014.

Wanting to Buy: Honda SL70, or Any Other Size SL Bike, Running or Not, or Even Parts. Call or Text 434-575-2687.



2013 Harley Davidson 1200 Sportster: 4,379 Miles, Added Comfort on Seat, Easy to Handle. Great for Beginner or Some Who Feel the Need for a Little Speed. Well Kept Covering. Asking \$8,000. Call 434-728-0412.

Musical

Kohler Piano, Very Nice, with Bench. Tuned Yearly. Asking \$500 OBO. Call 434-203-7684.

Tascam 2488 Neo 24 Track Recorder with Vocalist Live Effects Box, 4 Headphones and Mixer. Asking \$400. Call 434-251-1434.

Recreation

Junior Archery Set: Accessories Adjustable Sight, Finger Rollers, Draw 24"-26". Draw 25LBS. 2 Arrows. GenZ Buck Target up to 40LBS. Asking \$25. Call 434-489-1430.

Banshee Junior Archery Set: Accessories Adjustable Sight, Finger Rollers, Draw 24"-26". Draw 25LBS. 2 Arrows. GenZ Buck Target up to 40LBS. Asking \$25. Call 434-489-1430.

Recreational Vehicles

Countryside Service Center Complete RV Service, Roofing and Siding Repairs, Insurance Repairs Welcome. Full Service ONAN Dealer. Call 434-822-6994.

2004 Winnebago Sightseer Motor Home: Like New, 28K Miles, New Leather Seats, 32" Samsung TV, Color Backup Camera, New Mattress and Much More. Call for Price BETWEEN 9:00AM-5:00PM, 434-822-6025.

Reece Camper Hitch, Like New. 2.5/16 Ball All Sway Bars, Complete Hook Up. 15,000lb Weight Capacity. Call 434-713-4091.

Tools & Accessories

Chainsaw and Bench Grinder: Homelite 16" Electric Chainsaw, Asking \$55; Bench Grinder, Mounted on Portable Table, Asking \$75. Used Little. Pictures Online. Text 336-583-4304, or Call 336-503-0423.

Craftsman Tool Box with 12 Drawers with 5 Drawer Chest on Wheels, Side Shelf, with Keys. Paid \$800 New, Asking \$400. Call 434-857-6876.

Metal Brake with Top Lock Handle. Asking \$600 OBO. Call 336-939-0104.

NEW 4850 WATT DUROSTAR GENERATOR NEW 4850 WATT GENERATOR, ELECTRIC START, RUNS ON PROPANE OR GASOLINE, 120/240 VOLT. ASKING \$350 FIRM. CALL 434-709-0241.

WILTON VISE 6" Opening*: HEAVY DUTY SWIVEL VISE, IN GREAT OPERATING CONDITION. Please Bring Your Own Tool to Dismount from Table. Asking \$125. Call 336-514-7520.

Utility Trailers

Wanting to Buy 5x8 Trailer: Call 434-429-8436.

2018 Gatormade 6 x 14: Brand New, Only Used Once. Kept in Garage. Heavy Duty Gate. Asking \$2,500. Call 434-386-7777.

Wanted To Buy

Services of Someone with Flail Mower & plowing/tilling capabilities. Must be reasonably priced & dependable. 434-228-5669

Used Honey Extractor Looking to buy a used honey extractor in good working condition. Call: (434) 728-0363 E-mail: dkeithcollins@gmail.com (434) 728-0363 dkeithcollins@gmail.com

Want to Buy Honey Extractor Looking to buy used honey extractor in good working condition. (434) 728-0363 dkeithcollins@gmail.com

Looking to Buy Coin collections, silver coins, and large amount of sports cards. Call 434-728-3881.

Wanting to Buy: Service Station and Farm Gas Pumps. Call 434-728-2960.

Want to Buy 1969 Chevrolet Chevelle 2 door, with hard top to restore. Call 434-421-0201



Lemon Meringue Bars



CRUST

1 ½ cups all-purpose flour
 ½ cup powdered sugar
 ½ teaspoon salt
 ¾ cup unsalted butter, 11/2 sticks, cubed, room temperature

LEMON FILLING

3 large eggs
 1 egg yolk, reserve white for meringue
 1 cup granulated sugar
 ½ cup lemon juice
 1 tablespoon lemon zest
 ¼ cup all-purpose flour

MERINGUE

1 egg white
 1 pinch salt
 1/3 cup granulated sugar

PREPARATION

Preheat oven to 325°F (170°C). Grease and line a 9-inch (23 cm) square baking dish with parchment paper and place on a baking sheet.

Make the crust: combine the flour, powdered sugar, salt, and butter in a medium bowl, and use your hands to mix until a crumbly dough forms.

Transfer the dough to the prepared pan, and use your hands to press it against the bottom and about 1 inch (2 cm) up the sides. Poke the bottom all over with a fork.

Bake for 20 minutes, until light golden brown.

While the crust is baking, make the lemon filling: In a large bowl, whisk together the eggs and egg yolk. Add the granulated sugar, lemon juice, zest, and a pinch of salt, and whisk to combine. Whisk in the flour until just combined.

When the crust is done baking, remove it from the oven. Pour the lemon filling over the crust and carefully return it to the oven for 25 minutes, until the filling no longer jiggles and the center is mostly set.

While the filling bakes, make the meringue: In a clean, dry medium bowl, use an electric hand mixer to beat the egg white until stiff peaks form. Add about half of the sugar, whip for 30 seconds, then add the rest of the sugar and whip until combined. Transfer the meringue to a pastry bag fitted with a large tip or zip-top bag with a corner snipped off.

Pipe 9 evenly-spaced dollops of meringue on top of the lemon bars.

Return to the oven for 10-12 minutes, until the meringues are lightly browned.

Let cool completely, then refrigerate for 1-2 hours.

Slice into 9 bars. Serve chilled or at room temperature. Enjoy!

Looking to Buy Fall Decor for inside or outside. Call 434-709-2583

Looking to Buy 1964-1966 Chevy Truck Bench Seat, in Good Condition, at a Fair Price. Call 434-656-6563.

Wanted to Buy Double Wide Call 434-724-6862.

Looking to Buy square dog pin wire. 30-35 feet, 3 and a half ft. tall. Full or partial roll. Call 434-572-9377

Wanted to Buy UTV with dump bed. Call 434-792-2066

Looking To Buy Mower Would like to buy walk behind 5-8 HP sickle bar mower. Call 276-650-1864.

Looking to Buy Clear Glass Square Lids to Fit 1 Quart Size Corning Ware Cookware. Call 336-388-5089.

Looking to Buy a Kayak or Canoe. Call 434-203-2840.

Looking to Buy Nintendo, Nintendo 64 Game Systems, Controllers, Hook Ups and Games, in Good Condition. Must Work. Call 434-688-8572.

Looking to Buy Queen Size Box Spring, in A1 Condition. Preferably in Plastic, Reasonably Priced. Call 434-688-8572.

Looking to Buy Children's Metal Swing Set, in Good Condition. No Rust. Call 434-688-8572.



Yard Sales

Multi-Family Yard Sale Tue Aug 18th, 2020 from 08:00 AM - ? Large family yardsale. Womens clothing, shoes, jewelry, pand household items

120 Dual Track Rd. Chatham Fri Aug 21st, Sat Aug 22nd, from 9 AM - 2 PM. Inside Estate Sale. Vintage jewelry, household items, old tools.

416 Edgewood Dr. Sat. Aug 22nd. 8 AM - 12 PM. Remodeling Sunday School Sale. Furniture and More. Please park in the back.

Huge Garage Sale Sat Aug 22nd, 2020 from 08:00 AM - 03:00 PM Antiques-Collectibles Real nice stuff Something for everyone!

MOVING SALE. EVERYTHING'S GOTTA GO! Fri Aug 21st, 2020 from 07:00 AM - 12:00 PM Sat Aug 22nd, 2020 from 07:00 AM - 12:00 PM Dishes, cookware, framed artwork, 2 curio cabinets, kitchen table, lamps, home decor items, ladies jewelry, ladies clothing (most like new). Size range: 10-14: med, large & much, much more.

HUGE GARAGE SALE Sat Aug 22nd, 2020 from 07:00 AM - 12:00 PM. RAIN OR SHINE! LOTS of high-end furniture, decorations, and houseware items. Delivery of furniture must be provided.

Yard Sale Sat Aug 22nd, 2020 from 07:00 AM - 01:00 AM Housewares, craft items, men's & women's clothes, baby and children's items—toys, clothes, and other items. (434) 250-9433

115 Parrish Rd COMPLETE ESTATE LIQUIDATION SALE. Fri Aug 21st, 9 AM - 4 PM. Sat Aug 22nd, 9 AM - 4 PM. Sun Aug 23rd, 1 PM - 4 PM. Selling the estate of Irene Parham, 115 Parrish Rd. Danville. Way too much to list. Visit estate.sales.net for listings and pictures. Please wear a mask. Entrance will be limited and divided between main level and basement.

434 Wyatt Dr, Danville: MULTI-FAMILY HUGE YARD SALE!! Sat 8/22 from 8:00AM-12:00PM.

See you next week!

King Crossword
 Answers

Solution time: 27 mins.

D	O	H	A	D	O	B	L	A	S	S		
E	K	E	S	A	M	Y	O	L	K	S		
C	A	R	T	W	E	E	T	P	I	E		
A	P	T	A	N	G	L	E					
F	I	Z	Z	O	A	K	B	L	A	H		
				U	R	N	S	E	R	E	N	A
V	O	I	L	A			R	O	O	D	S	
E	N	O	U	G	H		J	A	N			
T	E	N	S			E	G	O	X	M	E	N
S	Y	L	V	E	S	T	E	R	L	A	W	
P	A	E	A	N		E	P	A	A	T	E	
A	M	I	N	E		S	H	Y		N	O	R

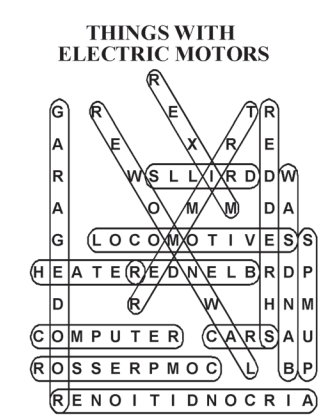

Weekly SUDOKU
 Answer

3	2	1	6	9	5	7	8	4
6	8	5	2	7	4	1	3	9
7	4	9	1	3	8	6	5	2
8	5	3	9	2	1	4	7	6
9	1	4	5	6	7	8	2	3
2	6	7	8	4	3	9	1	5
4	9	8	3	1	2	5	6	7
1	7	2	4	5	6	3	9	8
5	3	6	7	8	9	2	4	1

WANTED: GAS LAWN-MOWER Need a Small Gas Push Mower. On a Very Fixed Income. Please Call 434-770-4800.

Wanting to Buy: Call for Pricing. Junk Cars, Catalytic Converters, Radiators, Aluminum Wheels, Starters, Batteries, Radiators, Alternators and Transmissions. Call 434-250-6243.

Wanting to Buy Metal Porch Gliders and Chairs. Call 434-228-3121.

Want to Buy MILITARIA Civil War, Spanish American, WWI, WWII and Vietnam. Also Danville Military Institute (DMJ) Items, Antique Flintlock and Percussion Guns and Powder Horns. Call Donald Crane at 434-770-9790.

Wanting to Buy: Drip Irrigation Systems or Parts for Same. Water Timer Also Needed. Must be in Good Working Condition. Call 434-228-5669.

WTB: Old Heavy Stereo Equipment, Hifi Amplifiers, Receivers, and Reel-to-Reel Tape Decks. Brands like McIntosh, Pioneer, Sansui, Teac, Keenwood, Marantz. Cash Paid. Call 434-421-7918.

Looking for Old Porch Gliders and Chairs, Heavy. Cash Paid. Call 434-421-7918.

Wanted: 20" Boy's Bike, in Good Condition. Call 434-728-3222.

Looking to Buy Queen size bed, boxspring, mattress and headboard. Call 434-709-2583

Looking to Buy Sectional sofa at reasonable price. Call 434-709-2583

Looking to Buy 2 make up vanities. Call 434-709-2583

Local WTB: Used Vinyl Records, Any Size. Please Call before having Yard Sale. Also Interested in Buying Turntable and Reel to Reel. Call 434-203-9964.

Wanting to Buy: Unexpired Sealed Diabetic Test Strips. \$8 Box Of 50; \$16 Box of 100. Call 276-340-8559.

SUPER HERO 70's Comic Books: Looking for Older Super Hero Comic Books from the 40's-80's. Please call if you have some you are looking to sell. 434-203-5395.