



Elkhart Lake Depot Dispatch

*****ECRWSEDDM*****
Postal Customer

PRESORTED STANDARD
U.S. Postage Paid
Elkhart Lake, WI 53020
Permit No. 14
ECRWSS

January 2022

www.depotdispatch.com

www.elkhartlakechamber.com

FREE

Published by the Elkhart Lake Chamber of Commerce to support and promote its members and provide a service to the community

Christmas in the Square

Elkhart Lake's Christmas the Square event was held Saturday, Nov. 27 and drew large crowds for a variety of activities including a parade, tree lighting, children's games, choirs singing, carriage rides and more, extending into the following weekend when Santa and Mrs. Clause, sponsored by the Elkhart Lake Lion's Club, rode through the streets of the Village on one of the Elkhart Lake fire trucks.



photos by Missy Koehler, Pam Mathes & Rachele Paul



Victory Park

SUBDIVISION

Village of Elkhart Lake

Victory Park is a premier subdivision in Elkhart Lake that is conveniently located within walking distance to downtown and the excellent area schools.

Flat, partial and fully exposed lots to choose from.

Lots starting at \$49,900 • Home & Lot Packages starting at \$319,900

Featured in 2021 Parade of Homes



OPEN HOUSE

WEDNESDAYS 1:30-5:00pm
12/22, 12/29, 1/5, 1/19, 1/26
Or By Appointment

Wilmington Model

230 Victory Lane
5 bedrooms, 3 bathrooms
Finished lower level with walkout patio door
1,893 square feet on main level, with 1,234 square feet on lower level.
3,127 finished square feet total. Show Home-Not for Sale.

WERNER HOMES
(920) 458-4104
www.WernerHomes.com



Kensington Model
\$434,900

345 Victory Lane
4 bedrooms, 3 bathrooms
Finished lower level rec room with lookout windows
1,624 square feet on main level, with 785 square feet on lower level. 2,409 finished square feet total.



Duplex Condos
\$389,900
Model with finished lower level \$435,900

245 Victory Lane
1 unit available now, with more units under construction
2 bedroom, 2 bath.
Optional finished lower level with additional bedroom, bathroom and rec room.
Approx. 1,767 square feet on main level, with approx. 779 optional square feet on lower level.
Approx. 2,546 total finished square feet total available.

FREE Delivery OUR BIGGEST SALE EVER!!!

Over 250 Flexsteel Sofas, Recliners & Sleeper Sofas In Stock & On Sale!



RESTONIC
All components from Wisconsin

OUR BEST MATTRESS OFFER IN 20 YEARS!

ComfortCare®
New 2 sided flipable mattress system to prevent the 1 sided too soft, sinking, sagging mattress.



Save up to 30-75% Off

Entire Selection of Quality Flexsteel Sofas, Sectionals & Recliners in Fabric, Leather and Nuvo Leather

\$500 OFF
All Adjustable Beds

SPECIAL PURCHASE 50% OFF
\$977 *WHILE THEY LAST!*
QUEEN SET Reg. \$1,999
TWIN SET \$649 Reg \$1300
FULL SET \$749 Reg \$1700
KING SET \$1399 Reg \$2800

FLEXSTEEL®

Closed Christmas Day

MEISELWITZ

Where You Buy With Confidence Since 1898 • Downtown Highway 57 in Kiel



Hwy. 57 • Kiel • 894-2250
HOURS: MON. - FRI. 9-6
SAT. 9-3 • SUN. 12-3

Low Price Guarantee in North Eastern Wisconsin
OPEN 7 days a week!

1898 > > MEISELWITZ > > 1908 > > 1928 > > 1948 > > 1968 > > 1998 > > 2021

www.meiselwitzfurniture.com

January mystery photo



Can you identify the photo?

Take a look at the January mystery photo above. Do you know anything about it? Where is/was the location?

If you know, let us know!

To enter the January contest, send an email to depotdispatch@elkhartlake.com or a letter with as many details as you can to the Elkhart Lake Chamber, P.O. Box

425, Elkhart Lake, WI 53020, or drop off at the chamber office, 41 E. Rhine St.

The person with the best submission will receive a finely matted, quality enlarged print of the original, courtesy of Schamberger Gallery in Elkhart Lake.

Please share your guesses and help us keep the contest up to date.

December mystery photo



"This is a photo of the gazebo at Quit Qui Oc Golf Course. It's right next to the practice putting green or between the tee boxes for hole one and the fifth green. The gazebo is the perfect place to watch golfers come into the fifth green while have a cool drink and cheering on the golfers. The gazebo hosted several weddings and lots of photos of the wedding party. The clock was in the right place for all golfers to know when their tee time was." — Don Mersberger, Plymouth

DEPOT DISPATCH

January 2022 - No. 423

Published 12 times yearly by the Elkhart Lake Area Chamber of Commerce, to support and promote its members and provide a service to the community

© 2022 Depot Dispatch
All Rights Reserved

Publisher, **Pam Mathes and the Wisconsin Media Group staff**
Executive Director, **Melissa Koehler**
Membership Representatives,
Rachel Montaba, Branden Boerner and Mark Grasse
Contributor, **Marcia Schamberger**

Accounting, **Megan Martin-Rohr**
Distribution, **Abbey Hau**
and **Wisconsin Media Group**
Contributing Sponsors
Cleveland State Bank,
Friends of the Library,
Sargento
and **Sohn Mfg.**

Subscriptions
\$20.00/year (First Class)

Address correspondence or questions to the
DEPOT DISPATCH, P.O. Box 425, Elkhart Lake, WI
53020, or call (920-876-2922) between
9 a.m. and 4 p.m. For advertising questions, please call
and ask for Pam Mathes (920-894-2828).
E-mail address: depotdispatch@elkhartlake.com

The Depot Dispatch accepts non-member advertisements. It encourages and welcomes story contributions, press releases and event promotions from all members. Materials submitted for consideration will be reviewed by the editor, who reserves the right to adapt, as necessary. Submitted materials will not be returned unless specifically requested at the time of submission and accompanied by a stamped, self-addressed envelope.

Welcome
2022!



ALSO FEATURING

- Fun and casual on one side, fine dining on the other
- Extensive "spirit" selection featuring over 60 vodkas
- Offering over 600 wines, with 40 by the glass
- Outdoor dining available
- Full children's menu
- New Winter Hours: Mon.-Thurs. 4-9pm Fri. & Sat. 11am-9pm



21 S. Lake St. • Elkhart Lake • (920) 876-2142
www.lakestreetcafe.com • John & Lynn Shovan, Owners

WISCONSIN'S
Elkhart Lake
A legendary getaway

We love it here in Elkhart Lake!

Winter Ready?

See us for Winter Service Specials



Vehicle Repair
and Maintenance

- Oil Changes
- Brake Repairs
- Tire Replacements
- Shocks
- Carburetor Work
- Suspension
- Air Conditioning
- Computerized 4-Wheel Alignment
- Computer Diagnostics
- Exhaust Systems
- Transmission Rebuilds
- Engine Rebuilds
- Performance Upgrades
- Restoration
- Road Force Tire Balancing
- And More...

Import & Domestic • Vintage & Classic Cars

- ATVs
- Mopeds
- Snowmobiles
- Computer Shock Dyno
- UTVs
- Motorcycles
- Shock Rebuild
- Jet Skis
- Golf Carts



790 S. Lincoln Street, Elkhart Lake, WI 53020
920-876-4211 • www.wolfmotorsport.com

January 28 & 29, 2022

Priscilla Block



Sawyer Brown



Boots & Boogie

at The Osthoff Resort

Elkhart Lake, WI

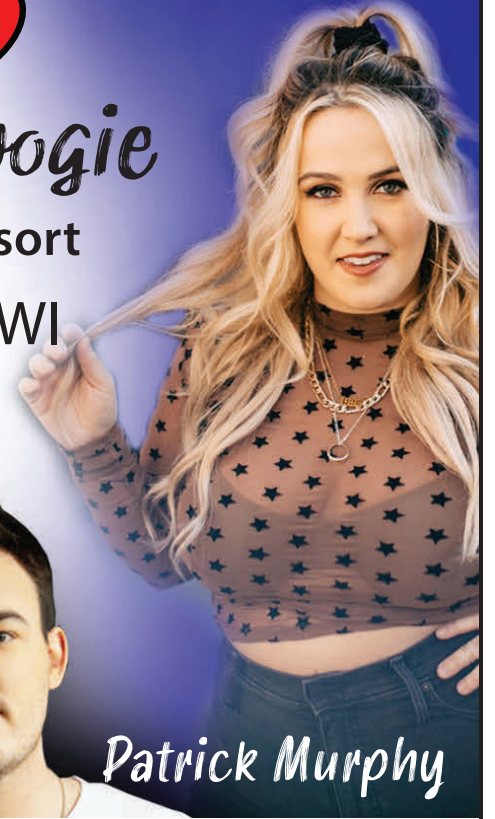

Patrick Murphy



Walker County

CELEBRATE BOOTS & BOOGIE AT THE OSTHOFF RESORT!

JANUARY 28 & 29, 2022, 7:30 PM

Dust off your country hats and shine your boots as you prepare for *Boots & Boogie*, featuring live country performances at The Osthoff Resort. We have an incredible lineup including Sawyer Brown, Priscilla Block, and opening acts Walker County and Patrick Murphy to fill out the two-evening schedule of live music performances!

General admission tickets include two nights of live music with four incredible performances for \$129.

Reserve your tickets now!
Call 920-876-3366 or reserve online
at osthoff.com/bootsandboogie,
or scan the QR code:



Elkhart Lake, WI

2 nursing students earn \$2K scholarships at LTC

Two nursing students at Lakeshore Technical College have been awarded scholarships by the Wisconsin League for Nursing.

Pietje Markus received a \$2,000 Bader Philanthropies, Inc. Gerontology Pre-Licensure Scholarship. Courtney Hunn received a \$1,000 Pre-Licensure Associate Degree Nursing Deaconess Scholarship.

Markus and Hunn are among 19 recipients from around the state. The scholarships were issued based on program of study, interest in gerontology and mental health specialties, future nurse educators and general nursing focus.

Markus is a Nursing-Associate Degree Program student. She earned her Nursing Assistant Technical Diploma at LTC in 2005. She is employed as an emergency department technician at Aurora Sheboygan Memorial Medical Center and expects to graduate from LTC in May 2023.

Hunn, a Whitelaw resident, is also a Nursing-Associate Degree student. She anticipates graduating in May 2023.

"We are very proud of our students and all they achieve. Knowing how competitive these scholarships are, we were especially excited to see that Pietje and Courtney were the only two-year college students selected. They are excellent representations of the high caliber nursing education students receive here at Lakeshore Technical College," said LTC Dean of Nursing Michelle Zautner.

For information on LTC's Nursing-Associate Degree nursing programs, visit gotoltc.edu/programs-and-courses/degree-programs/nursing-associate-degree.

Each year nearly 10,000 people enroll in courses at Lakeshore Technical College. They rely on LTC for job preparation, to earn a degree, upgrade a specialized skill, train as an apprentice, or seek a high school equivalency.

LTC is a nationally recognized technical college. The college was ranked the #2 two-year college in the nation for adult learners by Washington Monthly, #20 in the nation for two-year college educational outcomes by WalletHub.com, a top-150 two-year college by the Aspen Institute, and a top 10 Bellwether Award finalist for the third time in four years.



Courtney Hunns



Pietje Markus

Approximately 800 students graduate from LTC each year, and LTC's associate degree graduates earn a median salary of approximately \$52,000 per year. In addition to the Cleveland campus, LTC serves students in Manitowoc and Sheboygan, and offers classes at additional sites throughout the district. Visit LTC at gotoltc.edu.

A REALTOR® WHO CHECKS ALL THE BOXES!

- ✓ EXPERIENCED + KNOWLEDGEABLE
- ✓ LOCAL MARKET EXPERT
- ✓ COMMUNICATES WELL AND LISTENS
- ✓ USES PROFESSIONAL PHOTOS FOR EVERY LISTING
- ✓ ALWAYS HAS YOUR BEST INTERESTS AT HEART

Todd Smith REALTOR®
(920) 838-1770
Todd@PleasantViewRealty.com

920-894-7713
327 FREMONT STREET | KIEL, WI 53042

PROFESSIONAL PHOTOS INCLUDED WITH ALL LISTINGS

 MATT 207-5450	 KARI 980-0431	 GAIL 946-2693	 JIM 946-2854	 CONNIE 918-0698	 TY 918-0615	 TODD 838-1770	 WAYNE 286-0463
 CLEO 331-3567	 KAREN 207-4041	 KRISTINE 980-5542	 AMANDA 627-4225	 TAYLER 316-0237	 DONNA 980-2623	 JASON 917-0706	 SUE 254-7766
 NIKKI 980-4495	 JOHN 980-2539	 ROBBY 889-9982	 KELLY 980-3067	 RICH 262-573-1078	 DAN 530-9051	 ANNETTE 917-4419	

CALL ONE OF OUR
Pleasant Agents
OR VISIT US ONLINE!

OPEN HOUSE SCHEDULE



SCAN WITH MOST CAMERA PHONES OR A QR APP!

PLEASANTVIEWREALTY.COM

Thanks for reading the Depot Dispatch!

Mark Novitovic
Licensed Massage Therapist
Intuitive Massage, LLC
262-237-4719

Intuitive Massage, LLC
located at:
Charlene's of Elkhart
511 East Rhine
Elkhart Lake, WI 53020

- Highly skilled and compassionate massage therapy in Elkhart Lake since 2008.
- Customized massage using traditional and myofascial release techniques.
- Chair massage for your next event.
- Gift certificates available!

www.massageintuitive.com

OPEN DAILY AT 11 AM

2022 Golf Memberships now available!
Check out our website.

SNOWSHOEING
(Weather Permitting)
RENTALS AVAILABLE
Please call for details or visit our website

A Quit Qui Oc Gift Certificate makes a great gift!

CHRISTMAS SPECIALS

- Buy a \$50 gift certificate and receive \$5 in restaurant credit free. *Limit of \$25 of free credit*
- 18 Holes with cart \$45 *Limit of 5 per household*
- 3-30 Minute Golf Lessons \$120. *SAVE \$15*

SERVING LUNCH
Daily 11am-2pm
FRIDAY NIGHT Fish Fry 4:30-9pm
SUNDAY Breakfast 9am-1pm
RIB NIGHT Thursday, Jan. 20
CLOSED TUESDAYS

500 Quit Qui Oc Lane • Elkhart Lake • 876-2833 • www.quitquiocgolf.com | www.facebook.com/quitquioc



A new esports arena has been created at Lakeshore Technical College in Cleveland.

LTC opens new esports arena

Construction of a new state-of-the-art esports arena is complete and the space is now open to students at Lakeshore Technical College in Cleveland.

Students can play at no cost for fun or try out for competitive teams.

The college is a member of the National Association of Collegiate Esports (NACE), the largest member association of college and university sponsored esports

programs in the country. LTC teams will compete in the National Esports Collegiate Conference (NECC). More than 100 colleges and universities across the country compete in the NECC.

“As a member of the National Association of Collegiate Esports, we are excited to open this new arena and encourage students to visit and play for fun or try out for our competitive teams,” said LTC

President Dr. Paul Carlsen. “We look forward to giving the other teams in our conference some serious competition.”

The new 900-square-foot arena with ultramodern lighting features 11 gaming stations and two gaming consoles, all with hi-tech computers, monitors, headsets, keyboards and mice.

All students are welcome to play a variety of games including League of Legends,

Rocket League, Smash Bros., CS:GO, and Valorant. Competitive student teams will play League of Legends, Rocket League and Smash Bros.

A Smash Bros. tournament is scheduled for Jan. 5 at LTC. Admissions advisors are in attendance of esports events to assist in any details needed regarding LTC.

For more information and specific try-out times, visit gotoltc.edu/esports.

Schwaller's

Painting & Staining

High quality interior & exterior, residential & commercial painting & staining

Serving Elkhart Lake, Crystal Lake and the Surrounding area since 2004

Fully Insured • FREE Estimates

www.schwallerspaining.com • (920) 876-4020

Come join your fellow shutterbugs at the monthly meetings of:

The Elkhart Lake Camera Club

Meeting held 3rd Monday of each month • 7-8:30pm

Cedar Landing Club House
102 Cedar Lane, Elkhart Lake

For more information call 920-781-5004

Submit your news to the Depot Dispatch!

15TH ANNUAL • ONLY IN PLYMOUTH!

New Year's Eve Party & Sartori Big Cheese Drop

Friday, Dec. 31 • 8:30-Midnight

Live Music
8:30-Midnight

Cheese Drop
10pm

FREE Admission

PLYMOUTH ARTS CENTER

Happy New Year in the Cheese Capital of the World!

SARTORI

920.892.8409 • www.plymoutharts.org

Paceline Construction

New Custom Homes
Remodeling & Additions

(920) 876-4020

PacelineConstruction.com

DESIGN SHOWROOM BY APPOINTMENT:
101 N. Lincoln St, Elkhart Lake

Edward Jones

> edwardjones.com | Member SIPC

Transitions happen. Take charge of your future.

Paul Leal
Financial Advisor

110 Carr Rd
Plymouth, WI 53073-9500
920-893-8214

MKT-5894K-A-A1

Lakeland program aids students, employers

When students graduate from high school, they often think they need to choose between work and college.

Lakeland University has created a new program with major local employers that lets students do both.

Lakeland's Learn & Earn Program allows new members at partner companies to complete a full year of college while beginning their career at a company invested in their success. The three initial partner companies are Sargento, Masters Gallery Foods and Johnsonville, LLC.

The program is designed for upcoming or recent high school graduates who may want to earn a four-year degree, but because of a variety of reasons they have decided to enter the local workforce and not continue their education.

Learn & Earn leverages Lakeland's innovative Cooperative Education program, which allows students to earn academic credit for professional work experience along with their academic courses.

Lakeland will work with the student's employer to create a schedule that will allow them to balance their academic and career goals. Students in the Learn & Earn program will join a community of like-minded students who will be on the same academic and career journey.

"We want local high school graduates to understand that they don't have to pick between college or work, they can do both," said Rachel Carlton, dean of Lakeland's Kellett School for Undergraduate & Graduate Studies.

"And when individuals realize how affordable their education can be thanks to this partnership, it will truly open doors. Our Co-Op team is able to help individuals navigate the application process and help determine the types of careers individuals may be best suited for, leading to long-term success."

The program addresses the cost of school, which can be a barrier for many students and their families.

"By pairing Lakeland scholarships with competitive employer wages and tuition



benefits, students can start their career and finding an affordable way to complete a college degree," Carlton said. "Our program puts students in a position to graduate with little to no debt."

For the employers, the program is a new way to recruit members and expand their skill sets.

Johnsonville Owner Ralph Stayer said, "Other companies use their people to build a business, but at Johnsonville, we use our business to build our people."

Lakeland will assist students in choosing an employer partner that will be a match for their career goals. Lakeland's Co-Op team will help students navigate the application and on-boarding process with their chosen employer.

Upon hire, students will have a customized work schedule allowing them to work and take classes with a cohort of students who are on the same academic and career journey. Students will complete a full year of academic coursework, including Cooperative Education courses where students earn credit for their work-based learning.

The program follows a national trend of marrying work and going to school as a way for students to earn a college degree.

"With the cost out of reach for many families, a recent national study found that 74 percent of all parents of K-12 students would consider a route where their child would be hired directly out of high school by an employer that offers a college degree while working," Carlton said.

"One thing that has remained consistent is that college graduates on average earn more money during their lifetime and are less likely to be unemployed than those without a degree."

To learn more, visit the program's website at Lakeland.edu/learn or email getstarted@lakeland.edu.

Your Beautiful Holidays start here!

Wishing everyone a Blessed Christmas and a prosperous New Year!

Millhome
Nursery and Greenhouses, LLC
Landscaping & Garden Center

www.millhomenursery.com
N9469 Rhine Rd. (County E)
Elkhart Lake • (920) 894-7877
M-F 9-5 • Sat 9-4 • Closed Sundays

OPEN UNTIL NOON ON CHRISTMAS EVE

"Key to the Market"

FEATURED PROPERTIES

NEW LISTING

L10 County Road 1S, Newton
Over 150 feet of lake frontage, excellent location and mature foliage on the rolling topography of this parcel! Build here on Lake Michigan!

ACCEPTED OFFER

L10 County Road 1S, Newton
BREATHTAKING LAKE MICHIGAN FRONTAGE! 15.32 rolling acres that lead to spectacular views of Lake Michigan in all its glory. Property is just a short distance from Whistling Straits golf course; you will find it nestled between Sheboygan and Manitowoc just outside of the Town of Newton. Plenty of trees, wildlife, and Lake Michigan sunrises...

2 FAMILY

931 Eastern Ave., Plymouth
This 2-story duplex home is located in the central Plymouth. It has a newer 100 Amp electrical services, one furnace gas, forced air, and no central air. The tenants pay all their utilities and sold as is because seller is in nursing home.

CONDO

930 Blackstone Rd., Kiel
CONDO BUT NO CONDO FEES!! Story Condo offering 2 BRs, breakfast bar in the kitchen, sliding glass door to patio outside, lovely landscaping and first-floor laundry. Lower level is subbed for BA. Attached garage and driveway parking too! Maintenance free exterior! The tenant of this unit will pay for their own utilities. Unit 2 has lease till 10/31/2022, rent is \$860/month.

SOLD

5824 Superior Ave., Sheboygan
Well-maintained Town of Sheboygan home with updated kitchen and BAs. Hrdwd flrs in dining room & BRs. Beautiful deck & large private yard framed with mature arborvitae. Roof was new in 2016.

NEW LISTING

513 Chaplin Ct., Plymouth
Spacious 3 BR ranch with beautiful updates! Living room has plank floor, eat-in kitchen has snackbar area, updated cabinets & cooktop. The den includes a wet bar & French doors, Windows are newer, so are dishwasher & refrigerator. Beautiful deck and grounds in the backyard.

NEW LISTING

828 7th Street, Kiel
Beautiful 2-story 2-family duplex with 2.5-car detached garage. It contains a nice shower over tub and a vanity in each unit. Each unit pays separate utilities, owner does snow removal/lawn mowing. Home has all new vinyl replacement windows. Enclosed rear entry provides access to both units.

Properties are selling in days or hours! Time to cash in?

Cash in for max return on your investment today!

Does it make sense for you to sell? Is it your turn to buy? Upgrade, downsize or cash in and/or exchange an investment?

How much money is in today's market for you? Find out by contacting our team today!

Happy Holidays!

Katy Cain
Katy@AvenueRET.com
920.980.9302

Bill Cain
Bill@AvenueRET.com
920.980.2588

View all properties for sale at AvenueRET.com to receive property updates in minutes!

Donna Krueger
Donna@AvenueRET.com
920.627.1123

April Pirwitz
April@AvenueRET.com
920.917.0629

Jamie Ausloos
Jamie@AvenueRET.com
920.980.9133

Jim Haucke
Jim@AvenueRET.com
920.838.1175

Sue Erdmann
Sue@AvenueRET.com
920.286.2084

Kaise Elmer
Kaise@AvenueRET.com
715.853.4438

410 S Milwaukee St, Plymouth | 99B Lake St, Elkhart Lake
920-893-3001 | www.AvenueRET.com

Follow Elkhart Lake Chamber of Commerce on Social Media

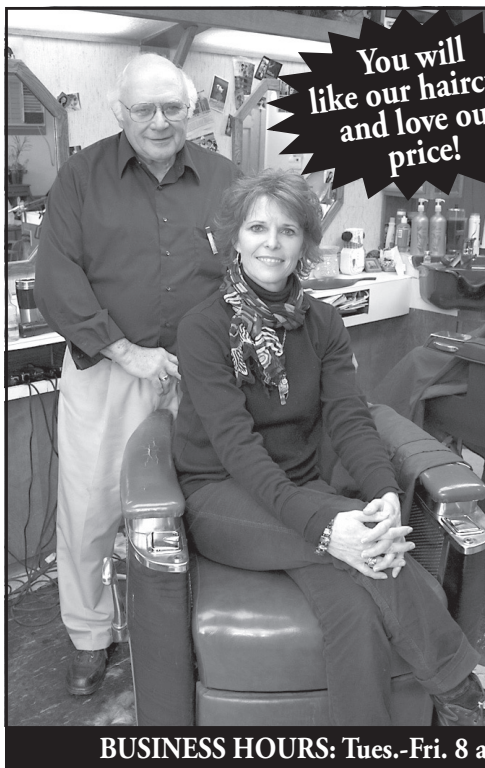

You will like our haircuts and love our price!

Cutting With Style

Dyanna Muldoon and her father Willie Mueller provide haircuts, styles, colors and perms for men and women.

Mueller's
Barber & Styling

325 Fremont St. • Kiel • 894-3939

BUSINESS HOURS: Tues.-Fri. 8 a.m. - 5:30 p.m. • Sat. 8 a.m. - Noon

Van Horn offers hands-on opportunities, career training



Van Horn Automotive Group's High Gear program allows apprentice technicians to work alongside experienced technicians for a period of two weeks.

Van Horn Automotive Group's exclusive in-house, fast-track program, "High Gear," can lead to a career as an auto technician.

Over a two-year period, High Gear apprentice technicians work alongside experienced technician mentors for hands-on training and real-world experience.

Van Horn Automotive Group provides high level training for candidates with two options for completion: (1) "Learn on the Job" while maintaining full-time employment with Van Horn or (2) "School to Work" while maintaining part-time employment with Van Horn while attending technical college. High Gear program benefits include scholarship opportunities, tool allowance, earn while you learn, real-world/hands-on experience, networking and job placement.

During the two-year period and upon completion, many doors open for the apprentices. The candidates will have a career opportunity as a full-time auto technician with Van Horn Automotive Group, participate in all manufacturing specified training and become a technician, complete ASE certifications, achieve

technical proficiency, and the tools purchased through Van Horn Automotive Group become the employee's property.

"In my short time in the High Gear Program at Van Horn I have already learned so many things that would have taken months to learn through an education.

In my opinion, on-the-job training is a fast track to enriching your automotive knowledge," said A. J. Klug, current Van Horn High Gear apprentice

Getting an education and deciding on a career path is not a cookie cutter process. Van Horn Automotive Group's High Gear

program is a master class in a palatable form that offers an opportunity for individuals to grow and gain competency in the workplace, feel good about what has been accomplished, and earn a good living with a great company, officials said.

Siebkens Resort



Join Siebkens Resort at
Nourish Farms
Community Dinner
Thursday, January 20th
5:30-7PM

Tickets & menu at
www.nourishfarms.org

Learn more about Nourish Farms' mission to provide equitable access to hands-on education and connections to local, sustainable food systems, Nourish empowers the community to make more wholesome food choices.

After Christmas Sale All Month!!!

We are here to help you!



- Estate Jewelry
- Unique Clothing S-3X
- Amazing Jewelry
- Men's Ties
- Gift Certificates



Shipping and curbside pick-up available

Alléchant Boutique LLC
217 East Mill St. • Plymouth • 920-893-9888
We Buy Gold & Silver

Open Most Days
10am to 5pm
Extra Hours By Appointment



KRAUS CONSTRUCTION Inc.

- Quality Custom Homes
- Commercial Additions
- Remodeling
- Decks
- Siding
- Roofing



Our
Commitment
to You...

Relationships
Integrity • Trust

510 Belitz Drive • Kiel
920-894-7008
www.krausconstruction.biz

MARSH MADNESS 3 Guys & a Grill at the Marsh

**Open 7 Days
per week!**

Serving Lunch & Dinner

**Serving Breakfast
Sat. & Sun. 8-11am**

*Accepting and fulfilling all
your catering needs!*



At Marsh Lodge
Elkhart Lake, WI

W7039 CO RD S R • ELKHART LAKE • 920.876.2535

Dine in only. No substitutions. No other offers can be combined.

- MONDAYS:**
(We will be closed the 3rd Monday of every month)
Beef Tenderloin Steak, Garlic Red Potatoes, Vegetable & Dinner Roll **\$10.99**
- TUESDAYS:**
3 Beef Tacos **\$4.99**
3 Fish Tacos **\$5.99**
- WEDNESDAYS:**
Burgers **\$2.50**
Rail Old Fashioneds **\$2**
- THURSDAYS:**
1/2 Rack of Baby Back Ribs, French Fries, Coleslaw, Dinner Roll **\$9.99**
- FRIDAYS:**
Fish and Seafood
- SATURDAYS:**
Prime Rib
- SUNDAYS:**
BBQ Pulled Pork Sandwich **\$3.50**

OH DEER!



**WE ARE HERE TO HELP WITH
ANYTHING YOU RUN INTO!!**
ALL INSURANCE COMPANIES WELCOME!

THEEL Auto

*Servicing
All Makes
and Models*

**SALES • SERVICE
AUTO BODY**

920.876.2703 • N8348 CTH J • ELKHART LAKE
Hours: Mon - Fri 8-5 • All Major Credit Cards Welcome

Seasons Greetings from all of us at the Depot Dispatch!

THE *Shore* CLUB
- WISCONSIN -

New Year's Eve Party

Doors open at 9:00
DJ plays 10-1 am



We are offering a...

Holiday Buffet

...PRIOR TO THE PARTY AT

The Cottonwood Social

New Year's Eve 5-10 pm

No reservations needed

11 AM UNTIL IT GETS TOO COLD OUT

TIKI BAR NEW YEAR'S DAY TRADITION

The
Cottonwood
Social
WILL BE OPEN

**POLKA BAND
BURGERS & BRATS
PIZZA BY THE SLICE
HEATERS**

THE *Shore* CLUB
- WISCONSIN -

www.shoreclubwisconsin.com

Family-friendly event held for LTC graduation

Students at Lakeshore Technical College have spoken and got their wish to have their educational accomplishments recognized during more of a family-friendly graduation rather than return to a traditional formal ceremony.

On Saturday, Dec. 18 more than 300 LTC students were recognized during the fall graduation celebration which began at 10 a.m.

Students arrived at Centennial Hall during their program's scheduled time-frame, had their name and degree announced, walked across the stage to receive their diploma, and began celebrating with family, friends and LTC representatives. Photo stations were available around campus and refreshments were served.

Like most colleges, LTC moved away from traditional graduation celebrations when the pandemic hit. Upon collecting feedback from graduates, administrators found it clear that students and their families preferred the most recent celebrations.

"Students deserve to be honored for their success in a manner they will always remember fondly. This graduation event will recognize their significant achievements and provide a celebratory campus environment," said LTC President Dr. Paul Carlsen.

Those wishing to celebrate graduation were welcome on campus. May 2020 graduates, who were provided with a virtual ceremony, were also invited to participate in person. LTC representatives from each division area attended during



A family-friendly graduation ceremony was held on the campus of Lakeshore Technical College on Saturday, Dec. 18. Photos could be taken at various stations, or perhaps on the bridge which is on the campus.

their designated time frames—Business and Technology; Agriculture, Apprenticeship, Automotive, Energy, Manufacturing, Public Safety; Health and Human Services; and May 2020 graduates.

All buildings on Lakeshore's Cleveland campus including the bookstore were open.

For additional details visit gotoltc.edu/graduation.



OPEN 24 HOURS

Full Service Laundromat

- Fluff & Fold
- Commercial Laundry
- Ironing

Imogene's Dry Cleaning Service

Drop off & Pick up done on **WEDNESDAYS**

Sippel's Lost Sock Laundromat

510B East Rhine Street • Elkhart Lake • 920-946-1750

SHOP LOCAL

Buy Elkhart Lake Chamber Cash and help support your community!

Available at the **Elkhart Lake Chamber of Commerce**
41 E. Rhine St., 920-876-2922
www.depotdispatch.com
www.elkhartlakechamber.com

Enjoy, explore, and embrace your best life – your way!



Cedar Community's Elkhart Lake Campus offers independent and assisted living, nestled on 14 acres near the heart of downtown Elkhart Lake. Senior living doesn't mean changing the way you live. It simply offers all the extra amenities and services, so you can focus on what matters most. No more worrying about what might happen next, from home maintenance and repairs, to needing additional care.

Cedar Community Elkhart Lake residents enjoy:

- Opportunities to engage with others in friendship, fellowship, and fun.
- All home maintenance and repairs included.
- No lawn to cut or snow to shovel.
- One campus, two levels of care.
- Peace of mind for yourself and loved ones.
- Private clubhouse.
- Salon and barber services.
- Beautiful surroundings.

cedar community

Elkhart Lake

<p>Independent Living Katelynn Hechel 920.876.4050 khechel@cedarcommunity.org</p>	<p>Assisted Living Rachel Wolfe 920.876.4050 rachel.wolfe@cedarcommunity.org</p>
<p>cedarcommunity.org</p>	



CELEBRATE *New Year's Eve*

AT THE OSTHOFF RESORT!

Kick off New Year's Eve at Concourse Restaurant & Lounge,
with fabulous dinner entrées and live entertainment
by Rosetti & Wigley from 7-10 PM.

Our lovely Elk Room will usher in 2022
with the live music of the Abler Boys from 9 PM-1 AM,
and a complimentary champagne toast at midnight!

For dinner reservations, call 920-876-5840.



www.osthoff.com • Elkhart Lake

Local Community Members...TREAT YOURSELF!

Receive 20% off Spa Services on

Tranquil Tuesdays

Valid on all 50- or 80-minute services.

On the day of your service, enjoy complimentary access to outdoor/indoor whirlpools,
sauna, meditation sanctuary, and locker rooms featuring cascading showers.

Advance reservations are required. Some restrictions apply. Call 920.876.5843.

Gift cards are available!



at The Osthoff Resort • Elkhart Lake

www.AspiraSpa.com

Hours: Thursday-Tuesday, 9AM-5PM



CHAMBER SPOTLIGHT Making Spirits Bright

Our December Chamber Member Spotlight is Making Spirits Bright.

Making Spirits Bright was initiated in 2012 by the Sheboygan County Rotary Clubs to provide a quality, exciting, family event and to collect much needed pantry items. To accomplish that goal, Making Spirits Bright partners annually with the Sheboygan County Food Bank (Food Bank). The pantry donations received at Making Spirits Bright are presented to the Food Bank, thus assisting them with fulfilling their two-fold mission:

- To feed the hungry through supporting and improving the food distribution system in Sheboygan County.
- To guide individuals seeking assistance to appropriate resources to meet their other basic needs.

Donations from Making Spirits Bright are delivered nightly to the warehouse for

storage and later distributed to the ten individual food pantries that comprise the Food Bank as well as 29 other partners throughout Sheboygan County. Each pantry then distributes these goods locally to those who truly need them.

Over 3,500 households are served by the Food Bank and its partners each year. In addition to the dedicated pantry partners, a variety of smaller non-profit service organizations also benefit from donations such as Bridgeway & Beyond, Safe Harbor of Sheboygan, and Nourish Farms.

Making Spirits Bright is open to the public from 5 to 9 p.m. every night from Nov. 26 through Dec. 31 (closed Christmas Eve, Dec. 24). So there are 35 total nights for people to drive the route.

To learn more visit them at www.makingspiritsbright.com.



An explosion of color awaits visitors to the Making Spirits Bright holiday light display in Sheboygan this season.

For all your labeling needs

SOHN
Manufacturing, Inc.

544 Sohn Drive, Elkhart Lake, WI 53020

920-876-3361

email: sohn@sohnmanufacturing.com

www.sohnmanufacturing.com

Submit your news to the Depot Dispatch!



HomeReview
Inspection Services, Inc.
RESIDENTIAL AND COMMERCIAL INSPECTION

SERVICES

- Winter Caretaking Inspections
While you're away, I'll check your home to make sure heat, water, etc. are working. \$50 per visit.
- Residential Inspections
- Commercial Inspections
- New Construction Inspections
- Phase Inspections
- Warranty Inspections
- Radon Screening

Serving Sheboygan, Manitowoc, Ozaukee, Washington and Fond du Lac Counties



Have a Happy & Healthy New Year!

Bob Turicik
920-892-7654

www.HomeReview.biz

www.facebook.com/HomeReviewWI

Have you pushed your cart at Tietz's Yet!



COUPON

PLU 29901

\$10.00 off

Your order totaling \$75 or more (excludes spirits).

With coupon. Good only at Tietz's Piggly Wiggly. One coupon per person. Valid through 1-31-22.

714 S. Wisconsin Dr, Howards Grove • (920) 565-4421

Authorized WIC Vendor



These Elkhart Lake-Glenbeulah students, grades kindergarten through eighth, were winners in the 2021-'22 Fire Safety and Prevention Poster Contest. The contest is sponsored by the Elkhart Lake and Glenbeulah

fire departments. Art teacher Amy Hammes and third-grade teacher Jane Schmidt co-chaired the contest. The first-place winners at ELGS will go on to compete at the state level.

Bob Schoenborn's JEWELRY

DIAMONDS • JEWELRY • WATCHES • CLOCKS • GIFTS

www.bobschoenbornsjewelry.com

307 Fremont Street • Kiel • 920-894-2772

Hours: Mon, Tues, Thurs 9am-5:30pm • Wed & Fri 9am-6pm • Sat 9am-1pm

Give the gift of deliciousness!

Culver's gift cards are available in any amount between \$5 and \$250. Order now online for delivery by mail, or stock up at your neighborhood Culver's.

Culver's BUTTERBURGERS & FROZEN CUSTARD

Culvers - Plymouth
2318 Eastern Ave • Plymouth • 920-893-2663
Open 10 am until 10 pm daily

ROAD AMERICA
N7390 HWY 67 [Gate 6]
920-892-8116

PADDOCK SHOP
shop.roadamerica.com

Last Minute? No Worries!

SHOP IN-STORE through Dec. 23, 10-4
SHOP ONLINE Orders will ship 12/23 and 12/27-30.
ORDER E-GIFT CARDS Online Anytime!

SHOP CLOSED Dec. 24 - Jan. 9
JANUARY HOURS Weekdays 10-4, starting Jan 10

Happy New Year!

YOUR LAKE LIVING CONNECTION!
Best Properties In The Best Locations

Chris Krieg
Elkhart Lake Resident
President's Circle Member
11 years of Client Satisfaction per Milwaukee Magazine 5 Star Award

the Krieg CONNECTION

FIRSTWEBER REALTORS
a Berkshire Hathaway affiliate

414-840-8486 • Ckrieg@Firstweber.com

For Sale in Victorian Village Resort (Shore Club)*

ACCEPTED OFFER!

NEW PRICE!
283 Poets Cove, Elkhart Lake:

- Executive Quality stand alone condo home
- 4400 sq. ft, 4 BR, 3.5 BA, 2.5 car GA
- Cherry millwork, cabinets, floors on all 3 levels!
- 129 ft level waterfront overlooking blue Elkhart Lake!
- Low maintenance, turnkey!

\$1,490,000 MLS #1757122

**Enjoy all resort amenities at "Shore Club" (Victorian Village Resort). Beach, dock, indoor/outdoor pools, Tiki bar, Bistro. Live the small town life! Walk to bars and restaurants!*

THE GREENS

NEW PRICE!

523 Otto Way, Elkhart Lake:

- Generously sized exposed ranch condo overlooks a treed pond teaming with turtles, birds and ducks!
- Well built unit has 3 large bedrooms (as well as 2 LL rooms with closets) and 3 full baths and lots of open space to entertain.
- Open floor plan with lots of natural light.
- Large deck along with LL patio for outdoor enjoyment.

\$539,000 MLS #1765066

Thankful for our wonderful Elkhart Lake!

Elkhart Lake SCHNEE DAYS 2022 Jan. 28, 29, 30

Friday, Jan. 28

10 a.m.—Storywalk at the Village Park (happening throughout the day)

5 to 7 p.m.—Sip N’ Schnee - Vintage Elkhart Lake (advanced tickets required)

5 p.m.—Fish Fries & Fires - Quit Qui Oc Golf Course

6 p.m. to midnight—Schnee Days at The Hard Left Lounge - Siebkens Resort

7:30 p.m.—Boots & Boogie - The Osthoff Resort (must buy one ticket for both Friday and Saturday); Patrick Murphy and Priscila Block

8 p.m. to midnight—Live music at The Shore Club Theatre - Pineapple Hunks (doors open at 7 p.m.)

Saturday, Jan. 29

8:45 to 9:45 a.m.—race day registration opens for the 10 a.m. 2 mile/5K - Run/Walk Schnee Lauf Race Day Quit Qui Oc Golf Club. Register at www.elkhartlake-chamber.com/schnee-days

10 a.m.—Storywalk at the Village Park (happening throughout the day)

10 a.m. to 2 p.m.—Cozy Crafts & Cocoa - Elkhart Lake Library

10 a.m. to 4 p.m.—Disc Golf Challenge at Road America

9 a.m. to 4 p.m.—Sledding at Road America - \$10 per carload

10 a.m.—2 mile/5K - Run/Walk Schnee Lauf Race Start at Quit Qui Oc Golf Club on Golf Course Road.

10 a.m. to 3 p.m.—snow shoeing at Quit Qui Oc Golf Club (snow shoe rental avail-

able at Quit Qui Oc) For more info call: 920-876-2833

10 a.m. to 2 p.m.—Schnee Days Brunch at Lakestreet Cafe

11 a.m.—Schnee Lauf Race Awards Ceremony at Quit Qui Oc Golf Club

11 a.m. to 4 p.m.—Winter Cocktail Classes offered at The Concourse Restaurant & Lounge (advance tickets required)

11 a.m. to 5 p.m.—open ice skating at June Vollrath Park (bring your own skates); sledding at the school hill and other outdoor activities around the village

2 to 6 p.m.—Schnee Days Spirits Stroll at various businesses around the area

2 p.m. to midnight—Schnee Days at The Hard Left Lounge - Siebkens Resort

6 p.m. to midnight—Snowshoe Stroll - Quit Qui Oc Golf Course

7:30 p.m.—Boots & Boogie - The Osthoff Resort (must buy one ticket for both Friday and Saturday); Walker County and Sawyer Brown

8 p.m. to midnight—live music at The Shore Club Theatre - Cold Soda Club (doors open at 7 p.m.)

Sunday, Jan. 30

8:30 to 9:30 a.m.—Chili Cook-Off drop-off at Siebkens Main Dining Room

11 a.m. to 2 p.m.—Chili Cook-Off at Siebkens Resort; grilled cheese and brats by EL-GAA

Noon—children’s games and ice cube hunt on The Shore Club front lawn



Welcome New Chamber Member

WISCONSIN'S **Elkhart Lake**
A legendary getaway

Sheboygan County Conservation Association
PO Box 522 • Sheboygan, WI 53082 • www.sheboyganconservation.org

IMPRESS FLOOR CARE

Fully Insured
Local Family Owned
IICRC Certified Technician

STEAM CLEANING 920.564.4278

◆ Carpet ◆ Tile ◆ Furniture ◆

www.impressfloorcare.com

WISCONSIN'S **Elkhart Lake**
Chamber of Commerce

SCHNEE DAYS
Elkhart Lake | 2022

January 28, 29 & 30, 2022

Scan for the most up-to-date schedule and information



Elkhart Lake Village update

Village tax collection explained

Tax bills were mailed on Dec. 9.

Property taxes may be paid at the Village Offices at 40 Pine St. from 8 a.m. to 4:30 p.m. Mondays to Fridays. We will be closed on Dec. 24 and 27, Dec. 31 and Jan. 3. If the village office is closed, payments can be dropped in the drop box located to the left of the doors at the Pine Street entrance. You can also drop your payment off at National Exchange Bank & Trust or Cleveland State Bank in Elkhart Lake.

If you have any questions, please call the clerk's office at 876-2122. The first installment of taxes is due by Jan. 31. If you want to mail in your tax payment, please mail it to P.O. Box 143, Elkhart Lake, WI 53020. Receipts will not be mailed, unless a self-addressed stamped envelope is included.

Village holiday hours

The village offices will be closed on Dec. 24, 27 and 31 and Jan 3.

Garbage collection schedule

Christmas and New Year will have no effect on garbage collection. Collection will take place as usual during this holiday season.

Spring Election

NOTICE OF SPRING ELECTION
VILLAGE OF ELKHART LAKE
APRIL 5, 2022
STATE OF WISCONSIN
VILLAGE OF ELKHART LAKE
NOTICE IS HEREBY GIVEN that an election will be held in the election district of the Village of Elkhart Lake on Tuesday, April 5th, 2022. The term for the Village President and the Village Trustees begins on April 19th, 2022. All terms are for two years unless otherwise indicated. The following officers are to be elected to succeed the present incumbents listed:

OFFICE	INCUMBENT
Village Trustee	Terri Knowles
Village Trustee	John Schott
Village Trustee	Lynn Shovan

NOTICE IS FURTHER GIVEN, that the first day to circulate nomination papers is Dec. 1 and the final day for filing nomination papers in the office of the Village Clerk is 4 p.m. on Tuesday, Jan. 4.

Candidates must circulate nomination papers that can be obtained at the Village Hall. Twenty valid signatures are required. You can sign three trustee petitions.

Tax rate decreased for 2021

The overall village tax rate decreased by \$.05 per \$1,000 of assessed value. Municipalities, counties and schools continue to do more with less. Over the last 10 years, the village has continued to hold its portion of the property taxes steady. If your house is assessed at \$200,000 your tax bill will decrease by approximately \$10, depending on the lottery credit and first dollar credit, which may mean an even greater decrease in taxes.

Preserve Apartment Development

The Village Board held a public hearing for a rezoning of the property

that would be used for the Preserve Apartment Development. After the public hearing, they approved a rezoning of the property at 604 S. Lincoln St. that would accommodate the apartment development proposal. The board also signed a letter of commitment to the project. These items were necessary for the development to apply for tax credits. General Capital and Danna Capital have applied for the tax credits and should hear back in April 2022 with a decision. The Planning Commission and Village Board will continue to work on this project over the coming months. The proposal is for two apartment buildings with approximately 110 units in total. There will be one building for workforce/affordable housing and one building that is market rate apartments. There are still a lot of pieces to this puzzle that will need to be negotiated and worked through for the project to go ahead. If you have any questions, please contact Jessica Reilly at 920-876-2122.

Mailbox placement and snow plowing

The U.S. Postal Service has guidelines to follow when placing your mailbox at your residence. The mailbox needs to be 41 to 45 inches from the road surface to the bottom of the mailbox or the point of mail entry. The mailbox also needs to be six to eight inches back from the curb or curb line. Below is a drawing with these specifications. If your mailbox is damaged because of snow plowing and it does not meet the U.S. Postal Service guidelines, you will be responsible for any repairs or replacement that is needed.

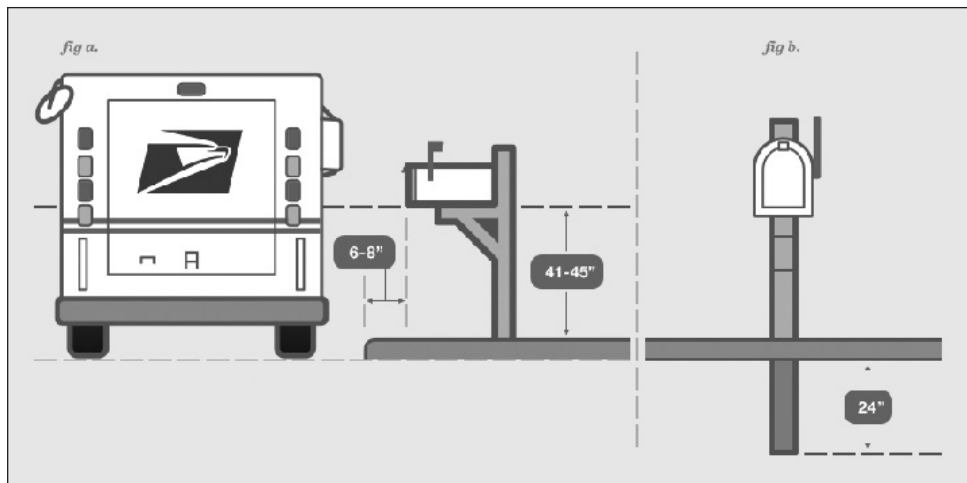

Victory Park Development

Houses continue to go up in the Victory Park subdivision. There are a few models available for viewing in the subdivision. If you are interested in more information on the subdivision or viewing some of the models you can contact Werner Homes at 920-458-4104.

Winter rules began Nov. 15

Winter parking regulations went into effect on Nov. 15. As a reminder, here is the ordinance.
Parking is allowed overnight in the North East Street parking lot overnight until 6 a.m. At that time your vehicle must be moved.

PARKING REGULATIONS

All Night Parking Regulated.
6.04(2) (a) No parking of any motor vehicle shall be permitted on either side

of any village street or in the parking lot north of Square Street between the hours of 2 a.m. and 6 a.m., and no parking in the lot on North East Street from 6 a.m. until 9 a.m. commencing the 15th day of November and ending on the first (1st) day of April of every year.

(b) Any vehicle parked in violation of the provisions of this ordinance shall be removed from the streets and stored, and such removal and storage shall be at the expense of the owner of said vehicle.

Vehicles violating this ordinance will be ticketed.

Snow Removal Warning

As in past years, you will not be notified that snow needs to be removed. If you have not shoveled in the prescribed time, the village will shovel your walk and bill the property owner. Also, the entire width of the sidewalk must be shoveled. A path is not sufficient, and you will be in violation.

Snow Removal

Ordinance 10.03 Removing Snow from Sidewalks: residents must clean snow and ice from sidewalks within 14 hours of any snowfall in a 24-hour period. Also, if you live at a corner intersection, remember you need to clear the sidewalk approaches to the streets.

Snow cannot be blown or plowed onto village streets. Residents must also shovel out any hydrants near their home.

Prescription drug drop-off box

As you do your spring cleaning please make sure you safely dispose of your old prescription drugs. The collection box is located outside the Police Department. Please take your medications out of their containers and just drop the pills in the

Elkhart Lake Village Board Members

If you have concerns or questions call any of our Village Trustees

PRESIDENT: Richard Sadiq, Pres. (POB 188) — (920) 207-4888. Email: rsadiq@elkhartlakewi.gov

TRUSTEE: Geoffrey Bray (POB 736) — (920) 452-5397. Email: gbray@elkhartlakewi.gov

TRUSTEE: Terri Knowles (POB 35) — (920) 876-3448. Email: tknowles@elkhartlakewi.gov

TRUSTEE: John Schott (913 Grasse Lane) — (920) 698-2480. Email: jschott@elkhartlakewi.gov

TRUSTEE: Lynn Shovan (POB 682) — (920) 207-4561. Email: lshovan@elkhartlakewi.gov

TRUSTEE: Paul Rudnick (POB 304) — (920) 946-8644. Email: prudnick@elkhartlakewi.gov

TRUSTEE: Mike Wolf (POB 506) — (920) 876-3100. Email: mwolf@elkhartlakewi.gov

informed of news and changes that may occur on occasion. We would like your email address. These will be kept confidential. We will remind you of changes in the garbage collection schedule and any other things that come up periodically.

Email Jessica Reilly at jreilly@elkhartlakewi.gov to be added to the list.

Happy holidays!



Original Art to Enrich Homes Gardens and Lives

Patrick and Karen Robison
244 E. Rhine Street
Elkhart Lake, WI 53020

January Hours
(excluding Jan. 1)
Saturday 10-5
And by appointment

920-876-3192
www.twofishgallery.net
www.facebook.com/twofishelkhartlake

box. We do not accept liquids.

Drop off anytime Mondays through Fridays from 9 a.m. to 4:30 p.m. For more information contact the Elkhart Lake Police at 920-876-2244 or for information on the Sheboygan County Program contact Elizabeth Ablor, public health nurse, at 920-459-3038.

Auto pay your water bill

The Village of Elkhart Lake accepts Automatic Clearing House (ACH) payments for your water/sewer bills. If you are interested in having your water/sewer bill automatically debited from your bank account, please contact the village at 920-876-2122 or email clerk@elkhartlakewi.gov and we will work to set you up on the program.

Email notification list

The village would like to keep you

Foundation conducts ornament fundraiser

Santa climbing down a chimney with his sack full of goodies will be the featured ornament design for the annual Elkhart Lake-Glenbeulah Education Foundation Ornament Fundraiser.

These commemorative ornaments are available by making a \$20 donation to ELGEF. This is a perfect way to make a contribution in honor or memory of someone special, or to give a collectible stocking stuffer. After the holidays, The ELG School District's newspaper, the Reporter Reporter, will publish an acknowledgement listing those who have contributed and in whose honor or memory the donations have been made.

This year's featured ornament, designed by sixth grade student Alexa Jelenc, is the 17th in a series of ornaments created by students in the ELG District. Alexa is the daughter of Justin and Tatum Jelenc. Her art teacher is Amy Hammes.

Ornaments are available at both school offices and the Elkhart Lake branches of Cleveland State Bank and National Exchange Bank & Trust. If you missed the some of the earlier ornaments in the series, you can round out your collection for an extra \$5 donation for each, while



Alexa Jelenc designed the ornament for this year's ELG Education Foundation Ornament Fundraiser.

photo by LesTension Photo

supplies last. If you have any questions or would like to order an ornament, please contact Ann Buechel Haack at 876-3381 or Debbie Hammann at 876-3307. Add to your collection or start now.

The Elkhart Lake Glenbeulah Education Foundation, a 501(c)(3) tax exempt organization, supports the School District in its mission to provide a caring, innovative learning environment. The

ELGEF provides resources and enhances opportunities not included in the school district's operating budget.

Read the Depot Dispatch online 24/7!
Go to... www.depotdispatch.com

PREPARE YOUR CAR FOR
Winter Driving

THEEL
Auto
SALES • SERVICE
AUTO BODY
SERVICING ALL MAKES AND MODELS

920.876.2703 • N8348 CTH J • ELKHART LAKE
Hours: Mon - Fri 8-5 • All Major Credit Cards Welcome

SteffeS
Builders, Inc.
Full Service General Contractor
Family owned & operated since 1949
810 Church Street, St. Cloud • (920) 999-2091
steffesbuilders@charter.net • www.steffesbuilders.com

over **60** years in the **Printing Industry** for all of your **Labeling Needs**

- custom rotary converting equipment
- flexographic label printing machines
- custom pressure sensitive labels

SOHN MANUFACTURING, INC.
544 Sohn Drive, Elkhart Lake, WI 53020
920-876-3361
www.sohnmanufacturing.com
email: sohn@sohnmanufacturing.com



Elkhart Lake Chamber Calendar

NOVEMBER 26-DECEMBER 30

Sheboygan County Historical Society and Museum-Holiday Memories, www.sheboyganmuseum.org.

NOVEMBER 26 - DECEMBER 31

Making Spirits Bright by the Sheboygan Rotary Clubs; 5 to 9pm; closed Dec. 24; makingspiritsbright.com

DECEMBER 31

Plymouth Arts Center-The 15th Annual Sartori Big Cheese Drop, 8:30pm to 12:30am. The highlight of the event is marked by a countdown and the lowering of a giant wedge of Sartori's world award-winning BellaVitano® Gold Cheese at 10pm

JANUARY 18

Stephanie Weill Center-Stayin Alive, 7:30pm Stayin' Alive is the quintessential tribute band to the Bee Gees, capturing the excitement of live performance and the tender subtleties of the human voice.

JANUARY 19

Stephanie Weill Center—Resurrection-A Journey Tribute, 7:30 pm Considered to be the gold standard by which all Journey tributes are measured, faithfully recreates the experience of a 1980s Journey concert.

JANUARY 22

Stephanie Weill Center-SPAMILTON: An American Parody. Hilarious musical spoof; 8pm.

JANUARY 30

Stephanie Weill Center-SSO "All of Us" fundraiser concert, 1pm. Featuring performances by the Sheboygan Symphony Orchestra, Sheboygan Symphony Chorus, and Sheboygan Symphony Youth Orchestra, this unique program offers an extraordinary experience for all ages and includes selections from "Star Wars," "The Sound of Music," "Wicked" and many more.

JANUARY 28, 29 AND 30, 2022

Schnee Days, Elkhart Lake-A weekend full of activities. See schedule on page 14.

FEBRUARY 5

Stephanie Weill Center-The Drifters, The Platters and Cornell Gunter's Coasters, 7:30pm Spend a nostalgic evening saluting three of the world's most beloved musical groups who were instrumental in creating the Rock & Roll/Doo Wop sound.

Regularly scheduled meetings & events

ELKHART LAKE CHAMBER OF COMMERCE BOARD MEETING

Held at the Grashorn Civic Center at 8:30 a.m. the third Tuesday of each month

VILLAGE BOARD MEETINGS

The Board of Trustees meets at the Grashorn Civic Center (84 N. Lake St.) on the first and third Mondays of the month at 7 p.m.

Agendas for all board and committee meetings are posted 24 hours in advance of the meeting at the Grashorn Civic Center, National Exchange Bank & Trust, Wisconsin Bank & Trust, the Post Office, and our website. In order to be on a board agenda you must notify the village clerk by the Wednesday before the board meeting.

VISITOR CENTER

Located at 41 E. Rhine St. in the heart of the

downtown. Stop in to pick up some information on area businesses and attractions.

Mondays to Fridays, 9 a.m. to 4 p.m.

Saturdays during Farmer's Market—8:30 a.m.

to 12:30 p.m.

Phone: 1-877-355-4278 or 920-876-2385

Email: tourism@elkhartlake.com Website: www.elkhartlake.com

AA MEETINGS

Held every Tuesday at 10 a.m. and Thursdays at 7 p.m. at Community United Church of Christ, 174 N. East St.

ELKHART LAKE STUDY CLUB

Meetings are held the first Monday of the month at noon and on the second Monday in September. Meetings are not held in January, July, and August.

Elkhart Lake Cutting Edge Quilters—first Wednesday each month at 1 p.m.

Bridge Improvement—Tuesdays at 1 p.m.

Book Group—second Mondays each month at 1 p.m.

CALENDAR SPONSOR



Providing financial options that are always in the best interest of our clients' success and the future of our communities.

CLEVELAND OFFICE: 1250 W. Washington Ave. Ph: 920.693.8256 • F: 920.693.8344 • TF: 833.321.9854

HOWARDS GROVE OFFICE: 502 S. Wisconsin Dr. Ph: 920.565.6000 • F: 920.565.6205

ELKHART LAKE OFFICE: 91 E. Rhine St., PO Box 548 Ph: 920.646.3150 • F: 920.781.5060



www.clevelandstate.bank



Four Seasons Comfort LLC

"Quality Service with Your Comfort in Mind"

W2074 Garton Road, Sheboygan • Office: 920-565-2095
426B Factory Street, Plymouth • Office: 920-893-8900

www.fourseasonscomfort.net

Heating • Air Conditioning • Infloor Heating • Sales & Service



Licensed / Insured
Mike Pelzel • Jeremy Lensmire

THE HARD LEFT Lounge

Open during Schnee Days for delicious food, world-class cocktails, & darts

Friday, January 28, 6PM-Midnight
Saturday, January 29, 2PM-Midnight

Schnee Days Chili Cook-Off
Sunday, January 30, 11AM-2PM

www.siebkens.com

920-876-2600



Stardus LIMOUSINE, LLC

Kiel 773-2270 • Sheboygan (920) 452-5696
www.stardustlimousine.com • Mike Hartmann, Owner

Huge Selection of Used Tires
14" - 20"

Over 2000 Tires In-Stock!

Buying scrap vehicles. Call for current price. Must be delivered.
Buying batteries. \$5 each

Rhine Auto, Inc.

W5695 Garton Road
Plymouth • 876-2779
Mon - Fri 7:30 - 5:00
www.rhineauto.com

Perfection

Elkhart Lake's Cody Schmitt becomes 4th to roll 900 series

Elkhart Lake native Cody Schmitt did something on the night of Tuesday, Nov. 16 which only three other people in state history have done.

Schmitt, 26, bowled a 900 series in the Tuesday Night League at Anchor Lanes—three consecutive perfect games, nothing but strikes.

It was only the 38th perfect 900 series verified by the U.S. Bowling Congress. It was the first time it has been done this year anywhere in the country.

Schmitt has now rolled 25 perfect games in his career and has 21 series in the 800s/900.

He said he rolled six warmup balls before his 900 series and all six of those were strikes as well. His next miss came two nights later when he left a 10-pin on his first ball in his Thursday league but still finished with an 853. He then rolled an 837 the following Tuesday.

Schmitt's previous high series had been an 879 in 2020, and he had an 859 in 2018.

He accomplished the perfect series on the final pair of lanes at Anchor Lanes, 11 and 12. That was where John Reiss rolled an 899 in 2000.

Schmitt's family has owned the lanes for about nine years. He officially has been running the Firehouse Pro Shop inside the center since the summer of 2019. He bowls as much as five times per week in addition to coaching the Elkhart Lake-Glenbeulah High School varsity bowling team.

As manager of the pro shop, Schmitt has access to new bowling balls a week or two before they are made available to the public. The ball he used to roll his 900 was still three days away from full release. But he said with a laugh that he was not in charge of oiling the lanes on the night of his 900 and that his dad will vouch for that.

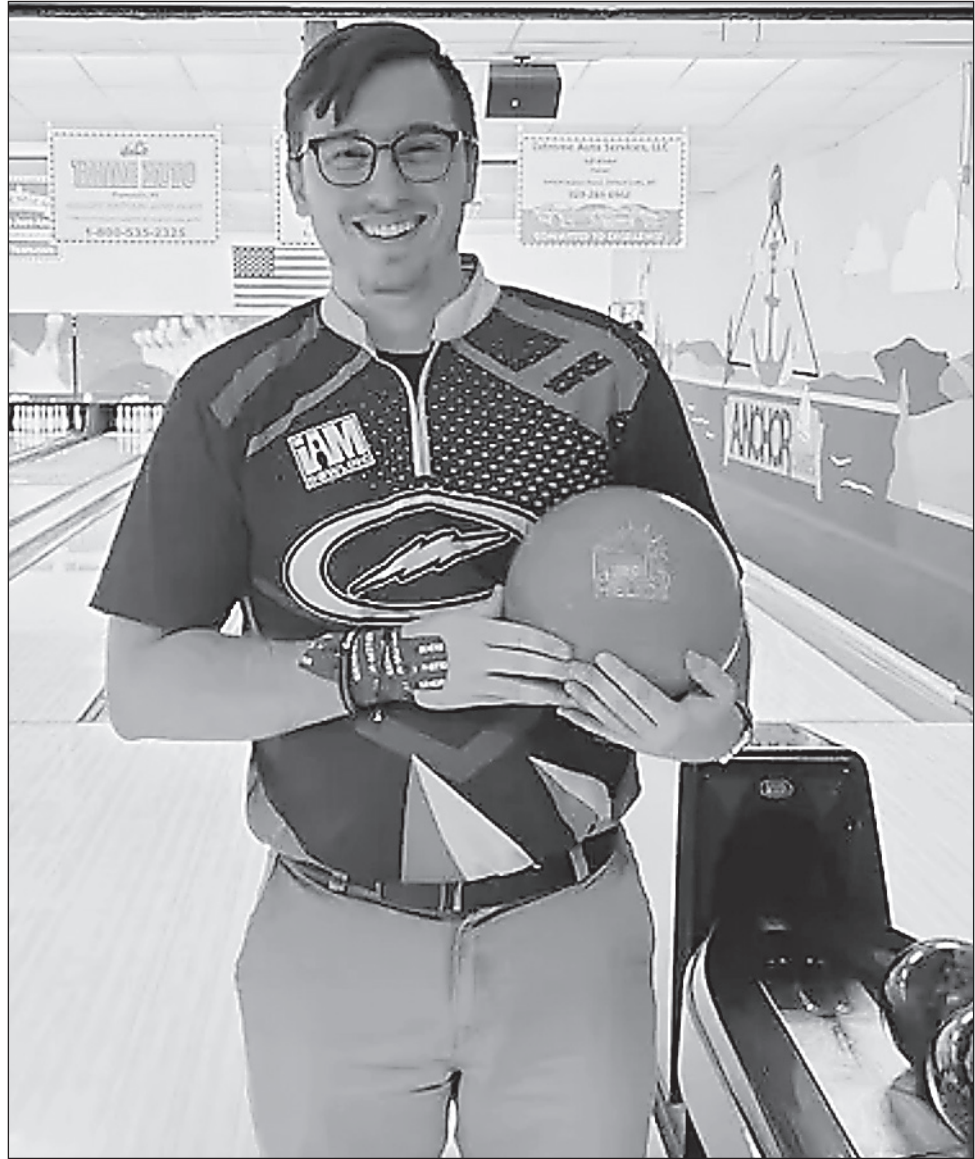

Cody Schmitt has now rolled 25 perfect games in his career.

Enjoy the art work of Elkhart Lake area students.

Brought to you by the generous sponsors of the greater Elkhart Lake area!

Elijah Loehr
ELGS

CSB
CLEVELAND STATE BANK

CLEVELAND OFFICE: 920.693.8256
HOWARDS GROVE OFFICE: 920.565.6000
ELKHART LAKE: 920.646.3150
www.clevelandstate.bank

Liam Wagner
ELGS

CSB
CLEVELAND STATE BANK

CLEVELAND OFFICE: 920.693.8256
HOWARDS GROVE OFFICE: 920.565.6000
ELKHART LAKE: 920.646.3150
www.clevelandstate.bank

Porter Miller
ELGS

SaraCote
PHOTOGRAPHY

111 E Rhine St., Elkhart Lake
651-387-1040
saracotephoto.com

Adalind Stecker
ELGS

St. Thomas Aquinas Catholic Church
94 Lincoln St., Elkhart Lake • (920) 876-2457
stthomasaquinasel.org

Olivia Godbert, ELGS

Est. **Siebkins** 1916
Resort

284 S. Lake St. Elkhart Lake • 920 876 2600 • siebkens.com

Arjen Anderson
ELGS

ROAD AMERICA

800-365-7223
www.roadamerica.com

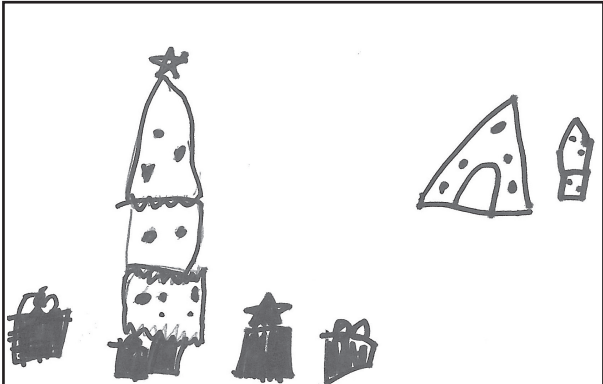

Kathleen Winkel, ELGS

Tim & Ann Buechel Haack, Elkhart Lake

Merry Christmas



Frankie Human ELGS

Lynn Schwensow "Premier Property Specialist"
920-946-4054 • lynn@lynn-sells.com
CENTURY 21 MOVES—SHEBOYGAN

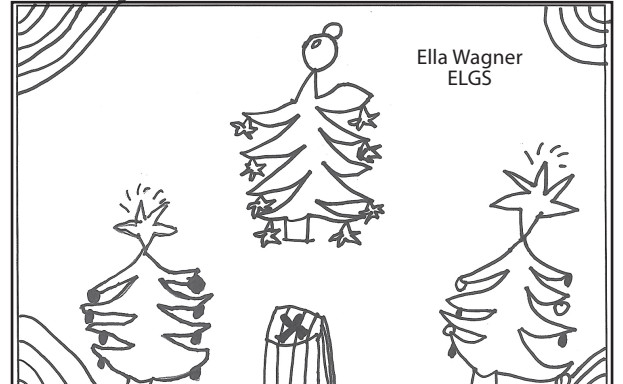

Ella Wagner ELGS

Ψ CAMP BROSIUS
SCHOOL OF HEALTH & HUMAN SCIENCES
N8089 County Road P, Elkhart Lake • 317-274-0606

Braylee Zorn ELGS

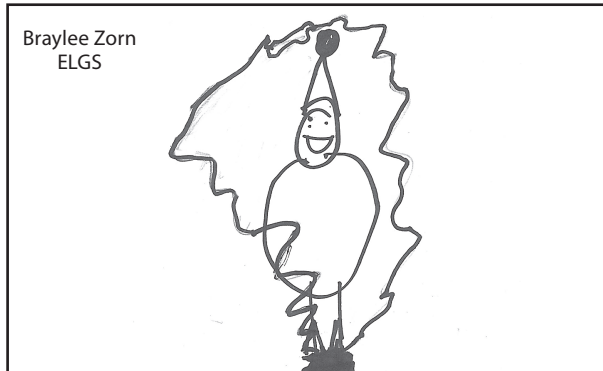

CSB CLEVELAND STATE BANK

CLEVELAND OFFICE: 920.693.8256
HOWARDS GROVE OFFICE: 920.565.6000
ELKHART LAKE: 920.646.3150
www.clevelandstate.bank



Ivana Dickinson ELGS

WISCONSIN'S
Elkhart Lake
A legendary getaway



Cylus Kleinhans ELGS

Four Seasons Comfort LLC
"Quality Service with Your Comfort in Mind"
W2074 Garton Road, Sheboygan • Office: 920-565-2095
426B Factory Street, Plymouth • Office: 920-893-8900
www.fourseasonscomfort.net

Levi Van Ess ELGS



Call (920) 226-0903

ElkhartCares

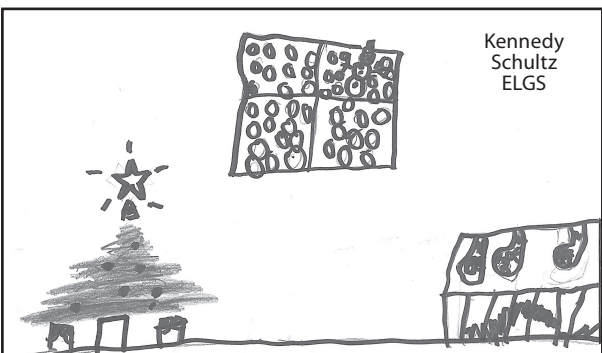

Kennedy Schultz ELGS

Lake Street Café
21 Lake St., Elkhart Lake
(920) 876-2142

Merry Christmas



Marian Guizar ELGS

CSB CLEVELAND STATE BANK

CLEVELAND OFFICE: 920.693.8256
HOWARDS GROVE OFFICE: 920.565.6000
ELKHART LAKE: 920.646.3150
www.clevelandstate.bank



Finley Mulholland ELGS

Culver's - Plymouth
2318 Eastern Ave • Plymouth
920-893-2663
Open 10 am until 10 pm daily



Aubrey Meeusen ELGS

Intuitive Massage, LLC
Mark Novitovic, LMT • 262-237-4719



Ty Blanke ELGS

The Friends of the Sheboygan Marsh
PO Box 301 • Elkhart Lake • 920-876-4312 • www.friendsofthmarsh.org
We are a non-profit 501(c)3



Nick Meyer ELGS

LIONS INTERNATIONAL

Elkhart Lake Lions Club

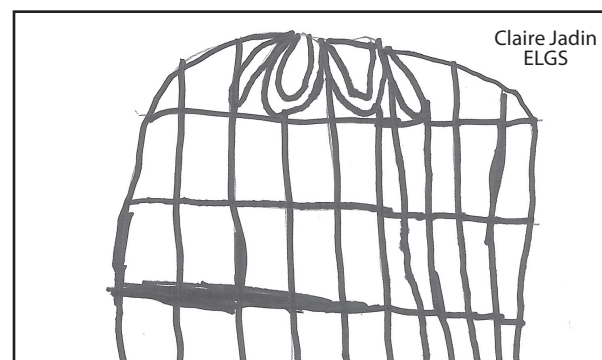

Claire Jadin ELGS

Elkhart Lake-Glenbeulah School District
201 N Lincoln Street • Elkhart Lake



Kaylyn Faber ELGS

LU LAKELAND UNIVERSITY
W3718 South Drive • Plymouth • 920-565-1000

Happy Holidays from all of us at the Depot Dispatch!

Kairo Doebert
ELGS



CSB
CLEVELAND STATE BANK

CLEVELAND OFFICE: 920.693.8256
HOWARDS GROVE OFFICE: 920.565.6000
ELKHART LAKE: 920.646.3150
www.clevelandstate.bank

Taylor Hill
ELGS



Log Cabin Inn
"DINING & SPIRITS"

633 Madison
Howards Grove
920-565-2712

Lillian Parlow
ELGS

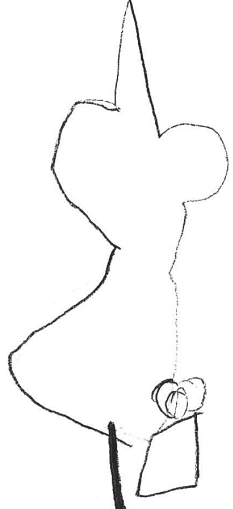

WISCONSIN'S
Elkhart Lake
Chamber of Commerce

Kylie Blanke
ELGS



Lynn Schwensow "Premier Property Specialist"
920-946-4054 • lynn@lynn-sells.com
CENTURY 21 MOVES—SHEBOYGAN

Elias Auch
ELGS



CSB
CLEVELAND STATE BANK

CLEVELAND OFFICE: 920.693.8256
HOWARDS GROVE OFFICE: 920.565.6000
ELKHART LAKE: 920.646.3150
www.clevelandstate.bank

Aotis Anderson
ELGS



Parker & John's
BBQ & PIZZA

Kiel • Sheboygan
Menasha • Green Bay

Jack Jensen
ELGS



National Exchange
Bank & Trust

Elkhart Lake • 274 Osthoff Ave.
920-876-2700
Glenbeulah • 105 E Main St.
920-526-3535
nebat.com

Gracelynn Konz
ELGS



Todd Smith REALTOR®
(920) 838-1770
Todd@PleasantViewRealty.com
"I always appreciate your referrals."

PLEASANT VIEW REALTY

Eleanor Breit
ELGS

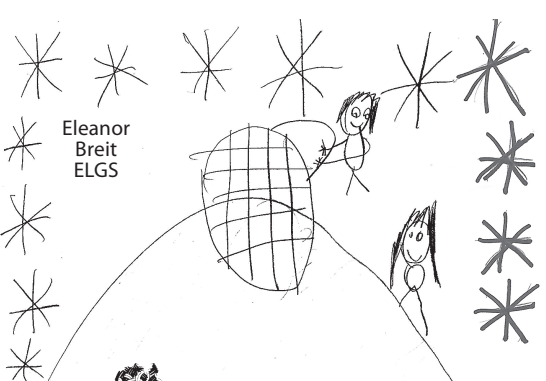

Quit Qui Oc
Golf Club

500 Quit Qui Oc Lane
Elkhart Lake • 920-876-2833
www.quitquiocgolf.com
www.facebook.com/quitquioc

Melissa Yoder
ELGS



THE OSTHOFF RESORT™

101 Osthoff Ave Elkhart Lake
920.876.3366
osthoff.com

Henry Jensen
ELGS



THE Shore CLUB
- WISCONSIN -

276 Victorian Village Dr.
Elkhart Lake • (920) 876-3323
shoreclubwisconsin.com

Oliver Zinger, ELGS

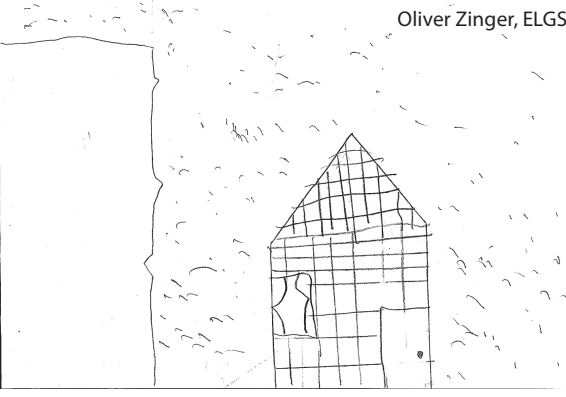

RUMORS ROADHOUSE
N7454 SUMMIT ROAD, PLYMOUTH • 920-781-5077

Brenan Henschel
ELGS



PLYCO

500 Industrial Road
Elkhart Lake • 1-800-558-5895
www.plyco.com

Palmer Wachter
ELGS



nest

823 N. 8th Street
Sheboygan
nesthomestore.com
920.803.6378

Hadleigh Porath
ELGS



Todd Smith REALTOR®
(920) 838-1770
Todd@PleasantViewRealty.com
"I always appreciate your referrals."

PLEASANT VIEW REALTY

Kohler Foundation plans live shows for '22

Kohler Foundation welcomes the public back to live performing arts in Kohler in 2022.

A lineup of high-energy, dynamic performances is planned for the 77th season of the Distinguished Guest Series.

The Distinguished Guest Series will open the season with world-renowned movement company MOMIX. The dynamic chamber orchestra Sphinx Virtuosi will take the stage in the second performance of the series, with 18 musicians who are the nation's top Black and Latinx classical soloists. The final performance of the season features international percussion sensation STOMP with a show that is explosive, provocative and utterly unique.

"We know the connective power of live performance and are excited to bring these exceptional performances to the community. We have a compelling range of expressive movement, music and dance to captivate the audience. Join us as we return to the renovated Kohler Memorial Theater for the 2022 Distinguished Guest Series," said Laura Roenitz, executive director of the Kohler Foundation.



Sphinx Virtuosi is comprised of 18 of the nation's top Black and Latinx classical soloists.

Kevin Kennedy photo

MOMIX

Friday, March 4 at 8 p.m.

Celebrating their 40th anniversary, MOMIX has been transporting audiences from their everyday lives to a fantasy world through its trademark use of magical lighting and imagery, thrilling fans in more than 22 countries. In an endless search for another gravity, Artistic Director Moses Pendleton combines athletic dance, riveting music, outrageous costumes, inventive props and pure talent to create an entertaining multimedia experience that will surprise, enchant and astonish.



The eight-member troupe STOMP comes to Kohler for two shows, May 12-13.

SPHINX VIRTUOSI

Friday, April 8 at 8 p.m.

The Sphinx Virtuosi is one of the nation's most dynamic, exhilarating professional chamber orchestras, dedicated to increasing racial and ethnic diversity in classical music. Comprised of 18 of the nation's top Black and Latinx classical soloists, the Virtuosi are primarily alumni of the internationally renowned Sphinx Competition, and its members work together as cultural ambassadors reaching new audiences. This unique ensemble earned rapturous reviews from The New York Times during its highly acclaimed debut at Carnegie Hall in December 2004: Allan Kozinn described their performance as "first-rate in every way" and raved that "the ensemble produced a more beautiful, precise and carefully shaped sound than some fully professional orchestras that come through Carnegie Hall in the course of the year."

with magnificent rhythms—matchboxes, wooden poles, brooms, garbage cans, Zippo lighters, and hubcaps. The inventive and invigorating stage show that's dance, music and theatrical performance blended together in one electronic rhythm, returns updated, and with new routines for all ages.

Season and individual tickets are available online at kohlerfoundation.org/tickets or by calling (920) 458-1972 (between the hours of 8 a.m. and 5 p.m., Mondays through Fridays). All events will be held at the Kohler Memorial Theater, 260 School St., Kohler.

At the Distinguished Guest Series, Kohler Foundation will require attendees and staff to wear face masks while in the venue and show proof of vaccination or negative COVID-19 PCR test result from within 72 hours prior to the performance. Events are being planned at full capacity.

Kohler Foundation is a nonprofit, private foundation that supports arts, education and art preservation initiatives in Wisconsin.

STOMP

Thursday and Friday, May 12 and May 13 at 8 p.m.

STOMP, the eight-member troupe, uses everything but conventional percussion instruments to fill the stage



MOMIX combines athletic dance, riveting music, outrageous costumes, inventive props and pure talent to create a multimedia experience.



D&D Carpentry

"Our name stands for quality"

OUR SPECIALTIES INCLUDE:
Additions • Remodel Work
Masonry • New Homes

General Contractors
 36 years of Serving our Community
 1324 Eastern Ave., Plymouth • (920) 526-3648
www.ddcarpentry.com

Follow us on:  facebook

ELKHART LAKE Public Library News

Grashorn Civic Center
40 Pine St., P. O. Box 387
Elkhart Lake, WI 53020

920-876-2554
elkhartlakepubliclibrary.org

Library Hours

Monday – Thursday 9 – 7
Friday 9 – 5
Saturday 9 – 2

ADULT FICTION

After Dark with the Duke, Julie Long
Ballerinas, Rachel Kapelke-Dale
Boy Underground, Catherine Ryan Hyde
Bryant & May: London Bridge is Falling, Christopher Fowler
Cat Who Saved Books, Sosuke Natsukawa
Harsh Times, Mario Llosa
History of Wild Places, Shea Ernshaw
Judge's List, John Grisham[^]
Little Hope, Ethan Joella
Net for Small Fishes, Lucy Jago
Past Life, David Mark
People From My Neighborhood, Hiromi Kawakami
Sea Hawke, Ted Bell
Small Things Like These, Claire Keegan
So Far and Good, John Straley
Tell Me How To Be, Neel Patel
These Silent Woods, Kimi Grant
W.E.B. Griffin Rogue Asset, Brian Anders
Wicked Widow, Beatriz Williams
Winter Guest, Pam Jenoff

ADULT NONFICTION

Defense Lawyer, James Patterson
Diabetes Code Cookbook, Jason Fung
Fix It and Forget It Mediterrean Diet
Killer By Design, Ann Burgess
Patient Zero: A curious history..., Lydia Kang
Profit and Punishment, Tony Messenger
Red Menace: How Lipstick Changed..., Ilese Carter

LARGE PRINT

Christmas Promise, Richard Paul Evans
Game On: Tempting 28, Janet Evanovich
Hidden Treasures, Michelle Adams
Not a Happy Family, Shari Lapena
Oh, William!, Elizabeth Strout

YOUNG ADULT

Between Shades of Gray, Ruta Sepetys (GN)
Righteous, Renee Ahdieh
The Upper World, Femi Fadugba

KIDS CHAPTER BOOKS AND GRAPHIC NOVELS (GN)

Bad Guys: They're Behind You, Aaron Blabey (GN)

Escape from Atlantis, Kate O'Hearn
Katt Loves Dog, James Patterson
Living With Viola, Rosena Fung (GN)
Shadows on the Mountain, Erin Hunter
Strangeville School is Totally Normal, Darcy Miller
When Pigs Fly 1, Rob Harrell (GN)

KID'S EARLY CHAPTER BOOKS AND WONDERBOOKS

Donut Delivery, Coco Simon
Iggy Peck and the Mysterious Mansion (Wonderbook)
Midnight Club, Shane Goth
Narwhal: Unicorn of the Sea (Wonderbook)
National Geographic Readers: Titanic (Wonderbook)
Pax, Sara Pennypacker (Wonderbook)

CHILDREN'S NONFICTION

Africa, Amazing Africa, Atinuke
Crazy Horse and Custer: Born Enemies, S.D. Nelson
Inside In: X Rays of Nature's Hidden World, Jan Schutten
Maria Tallchief, Christine Day
We the People and the President, P.J. Creek

PICTURE BOOKS AND BOARD BOOKS

Amos McGee Misses the Bus, Philip Stead
Better Together, Amy Robach
Biggest Little Boy, Poppy Harlow
Cold Turkey, Corey Schwartz
Construction Site: Merry and Bright, Sherri Rinker
Creature of Habit, Jennifer Smith
Croc O'Clock, Huw Lewis Jones
Is it Hanukkah Yet, Nancy Krulik
Little Red Sleigh, Erin Guendelsberger
Return of the Underwear Dragon, Scott Rothman
Simple Christmas on the Farm, Phyllis Alsdurf
Sun, the Moon, and the Stars, Rachel Minor
There's a Ghost in this House, Oliver Jeffers
This is a Gift for You, Emily Winfield Martin
Twenty Big Trucks in the Middle of Christmas, Mark Lee
Uni the Unicorn in the Real World, Paris Rosenthal
What the Dinosaurs Did the Night..., Refe Tuma
Where Snow Angels Go, Maggie O'Farrell
You're My Little Christmas Cookie, Nicola Edwards

ANNOUNCEMENTS

- The library will be closed on Saturday, Jan. 1 for New Year's Day.
- Wonderbooks are here! A Wonderbook is a print book with a ready-to-play audiobook inside. Kids can press play and follow along as the narrator reads the story. Great for increasing fluency and comprehension in young readers.
- Follow the library on Facebook and Instagram for up-to-date information on programs, services and more.

You're My Little Latke, Natalie Marshall
1619 Project Born on the Water, Nikole Hannah-Jones

AUDIOBOOKS, MUSIC CDS AND PLAY-AWAYS

Stranger in the Lifeboat, Mitch Albom (Play-away)
The Wish, Nicholas Sparks (Play-away)#

DVD'S AND BLU-RAYS

Card Counter
Cry Macho
One Night in Miami
Ron's Gone Wrong+
Shang-Chi and the Legend of the Ten Rings
Venom: Let There Be Carnage+

+ Blu-ray & DVD; * Lucky Day; ^ Also in Large Print; # Also in Audio CD or Playaway

Receive a complete list of new library materials every month by subscribing to our e-newsletter. Go to www.elkhartlakepubliclibrary.org, click on the CONNECT tab and select NEWSLETTER. We will only use this information for sending out our monthly newsletter.

SCHNEE DAYS

Storywalk® at Village Park, Friday and Saturday, Jan. 28-29—Stroll along the pages of the book "Bear Snores On" by Karma Wilson at the Village Park. When you are finished, pick up a hibernating bear activity at the library. (The Storywalk® Project was created by Anne Ferguson of Montpelier, Vermont and developed in collaboration with the Kellogg-Hubbard Library. Storywalk® is a registered service mark owned by Ms. Ferguson.)

Cozy Crafts & Cocoa—Saturday, Jan. 29, 10 a.m. to 2 p.m. Warm up at the library with snow-themed crafts and cocoa to-go.

KIDS

Winter Scene I Spy—Our display case has been transformed into a winter wonderland. Can you find what's hidden? Ask at the desk for a game sheet to play along!

Story Time, Thursdays at 9:30 a.m.—Stories, songs and activities for toddlers and preschoolers (babies welcome!). No registration required. Please

note that adults will be required to wear a mask and children are encouraged to wear a mask if they are able to do so. Please skip story time if you or your child are unwell.

Take & Make Crafts—New take and makes are available for preschoolers to middle schoolers, while supplies last.

School Year Reading Challenge—Keep reading all year long with the School Year Reading Challenge. Read just three hours per month to earn monthly incentive prizes as well as tickets for the grand prize drawing at the end of May. Sign up on the Beanstack app or register at the library. JK-12th grade.

MIDDLE SCHOOL, HIGH SCHOOL AND ADULTS

Bullet Journal Workshop (registration required)—Friday, Jan. 7 from 3:15 to 4:45 p.m. or Saturday, Jan. 8 from 10 to 11:30 a.m. Bullet journaling is a creative outlet that turns your daily planner into a work of art. All participants will receive a bullet journal and a demonstration to get started. We are offering two sessions and will limit participation. Call 920-876-2554 or stop at the desk to sign up. Masks are required at the workshop!

ADULTS

Tech Thursdays (drop in noon to 2 p.m.)—Want to learn how to use our Libby app for digital books or digital audiobooks? Having trouble with your Kindle? Drop-in tech help is available Thursdays between noon and 2 p.m. To arrange for tech help during another time, please call 920-876-2554.

Coffee Hour and Book Chat—Wednesdays at 10 a.m., Grashorn Civic Center. Interested in joining the conversation? Contact us at elcirk@monarchlibraries.org or 876-2554 to be placed on our Coffee Hour list to receive updates. Registration not required.

Book Club—Friday, Jan. 14 at 1 p.m., Grashorn Civic Center. Anxious People by Fredrik Backman. "A poignant, charming novel about a crime that never took place, a would-be bank robber who disappears into thin air, and eight extremely anxious strangers who find they have more in common than they ever imagined." Order your copy on monarchcatalog.org. Contact the library at elcirk@monarchlibraries.org or 876-2554 to be placed on our book club list to receive updates.

Broadway returns to Sheboygan for the first time in a decade!

The National Touring Broadway Production of An Officer and a Gentleman is coming to the Weill Center in Sheboygan on February 28.

An Officer and a Gentleman, based on the Oscar-winning film starring Richard Gere and Debra Winger, is a breathtaking production that celebrates triumph over adversity and includes one of the most iconic and romantic endings ever portrayed on screen.

The musical is directed by Scanlan with choreography by Patricia Wilcox (Mousetrap, A Night with Janis Joplin).

Zack Mayo's got smarts and a body built for US Navy pilot boot camp, but he also has too much swagger... until he meets a drill sergeant who's determined to drill his arrogance out of him. Zack finds comfort in the arms of a local factory girl. But it

isn't until tragedy befalls a fellow candidate that Zack learns the importance of love and friendship, and finds the courage to be his best self and win the heart of the woman he loves.

For more information go to weillcenter.com

Grace Lutheran Church

Sunday Divine Service.....8 & 10:15 am
Thursday Divine Service..... 7 pm
Bible Class
• Wednesday 9 am and 7 pm
• Sunday 9:15 am

Hwy 67, Elkhart Lake

SPONSORED BY

Our Family's Passion is *Cheese.*

NEUMANN
PLUMBING & HEATING

Plumbing & HVAC
Residential, Commercial,
Industrial & Remodeling

Residential Homes • Apartments • Hotels • Multi-Unit Buildings • Restaurants • Assisted Living Facilities

Call Neumann for ALL Your Plumbing and HVAC Needs

24 Hour Emergency Service
920-565-3345
neumannplumbing.com

Turn to the experts

1114 Millersville Ave
Howards Grove

OVER 50 YEARS OF QUALITY WORKMANSHIP

Make YOUR DREAMS Come True!

With a conventional home loan from NEBAT you can:

- ✓ Pay at Any Office
- ✓ Call Your Local Office with Any Questions
- ✓ Have a Free & Easy Pre-Approval Process

Let our knowledgeable lenders help get you started.

National Exchange

Bank & Trust

nebat.com/loans

Member FDIC | NMLS #411152

EL First Responders purchase ambulance

The Elkhart Lake First Responders have purchased an ambulance.

This volunteer group was looking for a vehicle to get personnel and equipment to various calls throughout the community. When this ambulance became available they recognized the opportunity to improve the services they can provide. The purchase could not have taken place without the support and very generous donation from Elkhart Cares.

The ambulance will be used at any call where specialized equipment may be needed. For example, at a car accident the emergency lighting on the vehicle will help to keep the scene visible for the safety of responders as well as any patients involved. The First Responders will also use the vehicle on fire calls to monitor the health of firefighters, and to transport training aids to CPR classes that are held throughout the community.

The new rig will allow for shelter from inclement weather conditions. "We've had several calls involving heat-related issues at the parade and the triathlon. Having a mobile space that is temperature controlled could be a real life saver," Michael Meeusen, service director of the First Responders, said. "This will be an invaluable tool to help us provide emergency care to the residents of the town and village, and we are very grateful for the support from Elkhart Cares that made it possible."



The Elkhart Lake First Responders have purchased and ambulance to help them in a variety of ways.

photo courtesy of Sara Cote Photography

The group will continue to stock the ambulance with medical equipment over the coming months. If you would like to

donate toward that goal, you can send your donations to the First Responders at P.O. Box 72, Elkhart Lake, WI 53020.

Special thanks to Sara Cote Photography for the pictures of the new rig.

WISCONSIN'S
Elkhart Lake
A legendary getaway ~ Tourism

Follow Elkhart Lake
Chamber of Commerce
on Social Media



Parker John's BBQ & PIZZA

COMING SOON TO OSHKOSH! FEBRUARY, 2022



**LOCATIONS ALSO IN
KIEL - MENASHA - SHEBOYGAN - GREEN BAY**



Lynn Schwensow

Premier Property Specialist MovesRE.com

Mobile: 920-946-4054

e-mail: lynn@lynn-sells.com



2022

Wishing you PEACE
LOVE and
LAUGHTER
in the NEW YEAR

*~HAPPY NEW YEAR~
My New Year's Wish is to be
Your Realtor! Let my years of
Experience Provide You With
Excellent Professional Service!*

Happy Holidays!

HOME, GARDEN, GIFTS & HOLIDAY

AFTER CHRISTMAS SALE!

Starts December 24

**Christmas
Items up to
60% Off**



N6625 STATE ROAD 57
PLYMOUTH
(2 Miles North of Hwy. 23)
920-893-8700

www.wreathfactoryonline.com

[@wreathfactoryplymouth](https://www.facebook.com/wreathfactoryplymouth)

[@thewreathfactory](https://www.instagram.com/thewreathfactory)