

**MAY 2022**

# American Lumber & Pallet

Loaded with Pages and Pages of New & Used Equipment and More!

**Sawmills ★ Pallet Mills ★ Woodworking ★ Logging**

## In This Issue:

### Auctions

#### James G. Murphy Co.:

May 18th • Kettle Falls, WA

Page 50

June 7th • Grangeville, ID

Page 51

June 16th • Townsend, MT

Page 52

#### Bright Star Realty & Auctions:

May 12th • Elkin, NC

Pages 56-60

June 16th • Bowman, SC

Page 60

May 18th • Augusta, WV

Page 62

May 19th • Mahaffey, PA

Page 63

May 20-21st • Virtual Auction

Pages 64-69

July 1st • Consignment

Page 69

Sept. 15th • Williamsfield, OH

Pages 69

#### Wausau Auctioneers:

May 25th • Prairie du Chien, WI

Pages 80-81

### Hot On The Market!

The Rivet Beast

... Page 89

## Cut Your Own Path to HIGHER PROFITS



**MAXIMUS®**  
High-Volume Precision Crosscutting  
with Integrated Package Aligner  
and Loop Bander

**AUTOCUT®**  
High-Volume Automated Crosscutting  
with programmable PLC Controls



**SELECUT®**  
High-Volume PET and  
Market Premium Length Crosscutting  
with Integrated Power Package Squeeze



**TRANSCUT® II SERIES**



Portable Saws priced from \$7,990\*



Stationary Systems priced from \$29,999\*

**HOLTEC® V**  
PRECISION CROSSCUT SYSTEMS  
[holtecusa.com](http://holtecusa.com)

Designed to cut whole bunks of lumber to length in less than 60 seconds with an accuracy of +/-1mm (.040") and leave a planer finish.  
**It's that simple.**

\*Specifications and prices are subject to changes without notice and results are based on HOLTEC installed V-Series systems using Scratcher® chain technology. Proper maintenance is essential for accuracy and longevity of cutting components and your results may vary. Photographs may show systems with optional accessories. All trademarks are the property of their respective owners. ©2021 HOLTEC USA Corporation. All rights reserved.

**1-800-992-3432 ★ AMLUMBER.com**

PERMITTED  
STANDARD  
U.S. Postage Paid  
Atlanta, GA  
Permit No. 3592

AMERICAN LUMBER & PALLET  
P.O. BOX 1136  
FAYETTEVILLE, TN 37334



**Grizzly**  
Industrial®

**PURVEYORS OF  
FINE MACHINERY®  
SINCE 1983**

*Quality Machines, Great Prices!*

**12" 20 HP HORIZONTAL RESAW BANDSAW**

- Main motor: 20 HP, 220V/440V\* (prewired 220V), 3-Phase, 48A/24A
- Hydraulic tank motor: 2 HP, 6A/3A
- Hydraulic pressure: 775 PSI
- Maximum cutting capacity: 12" x 12"
- Distance from blade-to-conveyor table: 1/4" - 5"
- Saw wheel size: 28" x 7/8"
- Saw blade size: 168" x 1"
- Saw blade speed: 7300 FPM
- Conveyor belt size: 11 1/4" x 215 3/4" long
- Variable feed speed: 32 - 82 FPM
- Conveyor table: 12" W x 102" L
- Floor to table height: 35 1/2"
- Overall size: 81" W x 65 1/2" H x 108" D
- Approx. shipping weight: 2778 lb.



**WARNING!** †¹

**G0503 ONLY \$15,965<sup>00</sup>**

**\$795**  
SHIPPING  
(lower 48 states)

**24" 5 HP INDUSTRIAL BANDSAW**

- Motor: 5 HP, 220V, single-phase, 23A
- Table size: 33 1/2" x 23 5/8" x 2"
- Table tilts 45° right
- Floor-to-table height: 32 1/2"
- Max. cutting width left of blade: 24 1/2"
- Max. cutting height (resaw capacity): 16 1/4"
- Blade size: 180" - 181 1/2" long (1/4" to 1 1/2" wide)
- Blade speed: 5300 FPM
- Footprint: 41 3/8" x 23 1/2"
- Overall size: 48" W x 32" D x 83 1/2" H
- Approximate shipping weight: 951 lbs.



**MADE IN TAIWAN** **ISO 9001 FACTORY**

**WARNING!** †¹

**G0568 ONLY \$4,175<sup>00</sup>**

**\$350**  
SHIPPING  
(lower 48 states)

**80-GALLON 7 1/2 HP EXTREME SERIES AIR COMPRESSOR**

- Motor: 7.5 HP, 230V, single-phase, 31A
- Airflow capacity: 28 CFM at 40 PSI and 23 CFM at 90 PSI
- Maximum air pressure: 175 PSI
- Connection type: Female threaded valve
- Connection size: 3/4" NPT
- Sound rating: 79dB
- Overall size: 40" W x 32" D x 73" H
- Approximate shipping weight: 620 lbs.



**WARNING!** †¹

**MADE IN USA**

**G0942 ONLY \$2,595<sup>00</sup>**

**\$350**  
SHIPPING  
(lower 48 states)

**14" 10 HP 3-PHASE SLIDING TABLE SAW WITH DRO AND CNC FENCE**

- Digital controls for main blade tilt and rip fence adjustment
- Programmable CNC rip fence
- Accepts 12" and 14" blades
- Cross-slide table with eccentric locking clamp and hard chrome-plated slideway
- Easily adjustable blade guard with built-in dust hood
- Miter fence adjustable 30° left and 45° right
- Scoring blade virtually eliminates tear-out
- Sliding table on vertical guide system with precision bearing rollers



**MADE IN TAIWAN** **ISO 9001 FACTORY**

**WARNING!** †¹

**G0853 ONLY \$17,505<sup>00</sup>**

**\$575**  
SHIPPING  
(lower 48 states)

\*To maintain machine warranty, 440V operation requires additional conversion time and a \$250 fee. Please contact technical service for complete information before ordering.

FINANCING



**800-523-4777**

TECHNICAL SERVICE:  
570-546-9663

**grizzly.com**

Please visit grizzly.com for up-to-date pricing. Due to rapidly changing market conditions, our advertised prices may be changed at any time without prior notice.

**WARNING!** †¹ : Cancer & Reproductive Harm  
Some products we sell can expose you to chemicals known to the State of California to cause cancer and/or birth defects or other reproductive harm. For more information go to [www.P65Warnings.ca.gov/product](http://www.P65Warnings.ca.gov/product)

22187R

# Cut Your Own Path to HIGHER PROFITS

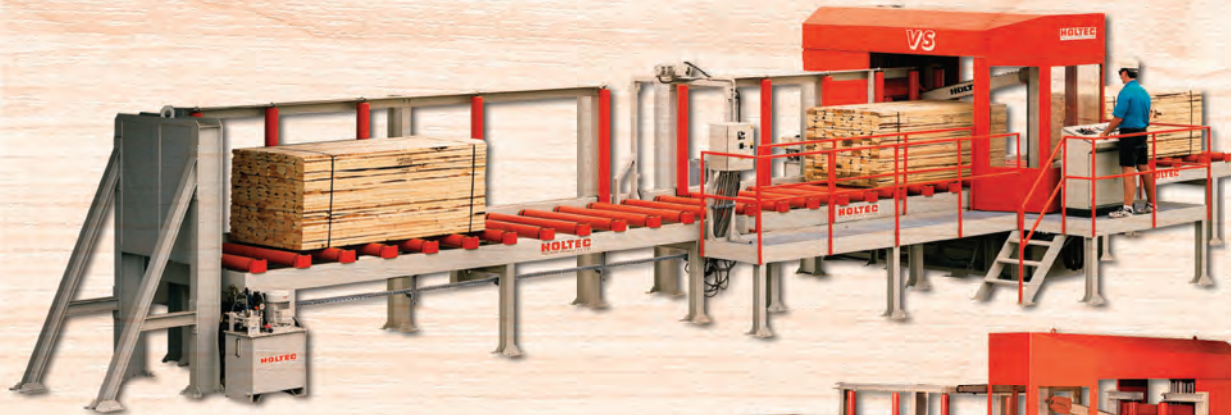

**MAXIMUS<sup>®</sup>**  
High-Volume Precision Crosscutting  
with Integrated Package Aligner  
and Loop Bander

**AUTOCUT<sup>®</sup>**  
High-Volume Automated Crosscutting  
with programmable PLC Controls



**SELECUT<sup>®</sup>**  
High-Volume PET and  
Market Premium Length Crosscutting  
with Integrated Power Package Squeeze



Portable Saws priced from \$7,990\*

## TRANSCUT<sup>®</sup> II SERIES

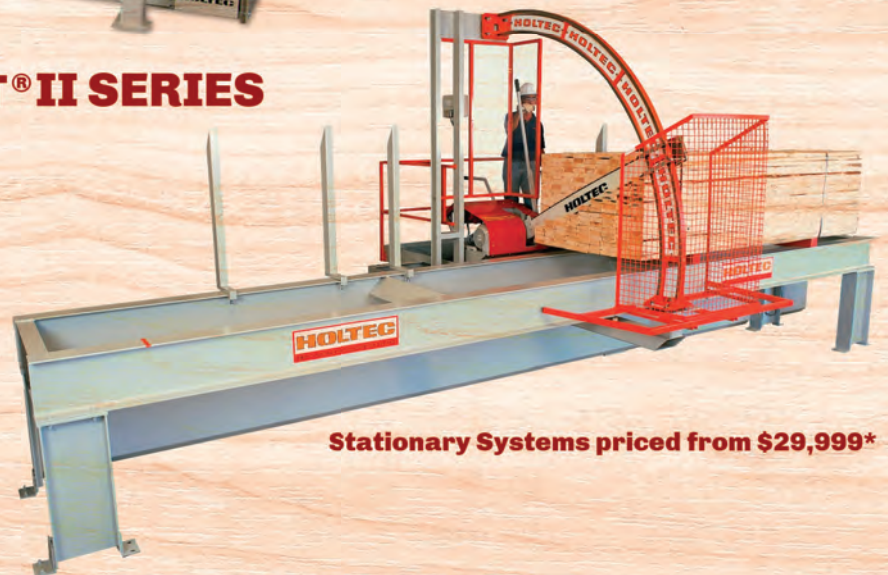

Stationary Systems priced from \$29,999\*

# HOLTEC<sup>®</sup> V SERIES

PRECISION CROSSCUT SYSTEMS

[holtecusa.com](http://holtecusa.com)

**Designed to cut whole bunks of lumber to length in less than 60 seconds with an accuracy of +/-1mm (.040") and leave a planer finish.**

**It's that simple.**

\*Specifications and prices are subject to changes without notice and results are based on HOLTEC installed V-Series systems using Scratcher® chain technology. Proper maintenance is essential for accuracy and longevity of cutting components and your results may vary. Photographs may show systems with optional accessories. All trademarks are the property of their respective owners. ©2021 HOLTEC USA Corporation. All rights reserved.

# Ask About Our Freight Assistance Program!

We Have the Industry's **BEST** Reputation for Used Sawmill and Planing Mill Equipment!



Schutte 80HZF  
Horizontal Grinder



Andritz Sprout  
Hammer Mill



Short Lumber  
Automatic Stacker



Schurman 4x24 Top  
Arbor Edger



Armstrong RH  
No.4 Sharpener



Newman G-280  
Knife Grinder



Brewco 1600  
Horizontal Resaw



Corley Hydraulic  
Log Turner



CM&E  
36in Chipper



Ingersoll Rand 50HP  
Air Compressor



Salem Air  
Strain Bandmill

**This is only a small selection from our HUGE inventory.**

Visit our website -

**[www.machinerysales.com](http://www.machinerysales.com)**

- or call us for help with your next project.



Precision 48"  
Chipper



Salem 36in  
LP Carriage



Turner 52in High  
Production Resaw



Western Pneumatics  
Fingerjoint Head Grinder



AEM  
Planer Sander



Tyrone 230 Hyd  
Carriage Drive

**Over 10 Acres of Machinery In Stock!**



**MACHINERY SALES CO.**

503-285-6691

Fax 503-285-0449

9802 North  
Vancouver Way

Portland, OR  
97217

Call (Toll Free) **1-866-241-2977**

For a complete equipment listing, go to

**[www.machinerysales.com](http://www.machinerysales.com)**

e-mail: [machsales@msn.com](mailto:machsales@msn.com)

[info@machinerysales.com](mailto:info@machinerysales.com)

Visit our YouTube channel at [www.youtube.com/user/machinerysales1](http://www.youtube.com/user/machinerysales1)

# Cut Pallet Stock, Studs, Fencing, I-Joists, Structural Components and More with the I-CUT SYSTEM from L-M Equipment.

**Most Accurate — Cutting Tolerance of  $\pm 1/32$ "!**

## Standard:

*\*Cutting capacity from 20' to 60' & longer, 48" high x 52" wide*

- Multiple package loading for increased production
- Precision linear bearing guide system to ensure longevity and accuracy
- 15 HP Heavy duty engineered saw drive assembly
- Positive package hold down mechanism with built-in saw guard
- .404 pitch saw chain with 5/16" kerf
- Maximum guarding for operator's safety
- Hydraulically operated

## Optional:

Laser light, Electronic length measuring, Auto cut cycle, Fully automated PLC controls, Operator weather protection, Built-in waste conveyors and lots more!



**L-M Equipment  
Company Ltd.**

604-576-0088

Toll Free 1-800-455-8807

Email: sales@LMSaws.com

[www.LMSaws.com](http://www.LMSaws.com)

## **Why Compromise?**

*With 60 years in the business, L-M Equipment has more package cross cut systems in operation than any other manufacturer in North America. We serve customers around the world.*

# DL HELFRICK

WHERE PRECISION MEETS CRAFTSMANSHIP

**0%**  
FINANCING

AVAILABLE FOR COMMERCIAL  
AND INDUSTRIAL USE

AVAILABLE IN:

AIR LOGIC  
ELECTRIC  
MANUAL

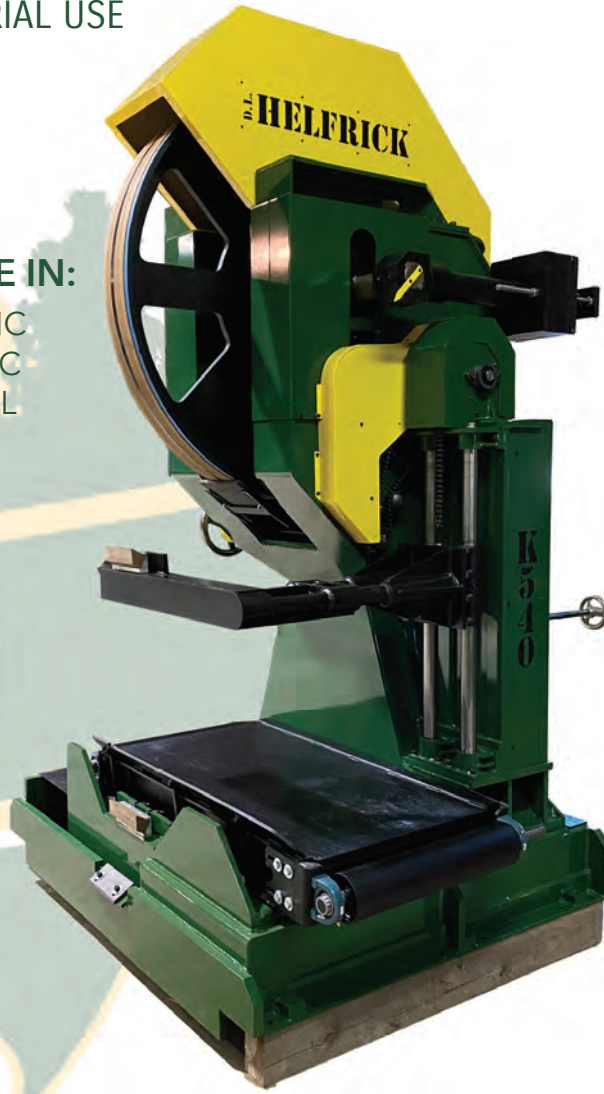

**D&D SAWMILL SERVICES**  
PARTS · SERVICE · SALES

3911 JACK ROAD, CHAMBERSBURG, PA 17202  
(717) 369-3654 | INFO@DDSAWMILLSERVICES.COM | DDSAWMILLSERVICES.COM



## American Lumber & Pallet

Sawmills ★ Pallet Mills ★ Woodworking ★ Logging

Published Monthly By:  
**ASKINS PUBLISHING GROUP, INC.**

P.O. Box 1136  
Fayetteville, TN 37334

**PUBLISHER/EDITOR**

Bill Askins  
bill@amlumber.com

**ADVERTISING SALES**

Shawn Askins  
shawn@amlumber.com

**1-931-625-1618**

Randy Tallman  
randy@amlumber.com  
**1-800-992-3432 Ext. 4**

**CIRCULATION DEPT.**

circulation@amlumber.com

**GRAPHIC DESIGN DEPT.**

Lyndsi Carroll  
lyndsi@amlumber.com

**PHONE: (931) 433-1010**

**TOLL FREE:**  
**800-992-3432**

Anywhere in the U.S.A. & Canada

**FAX: 931-433-1081**

**E-MAIL alp@amlumber.com**  
**www.amlumber.com**

**Subscriptions (Presorted Standard Mail)**

Free to Sawmills, Pallet Operations, Woodworkers, Veneer & Chip Mills and Loggers with portable sawmills in the U.S. Other businesses or individuals in the U.S. \$25.00 per year.

**Subscriptions (First Class Mail)**

U.S.A and CANADA - \$50.00 per year. Other foreign subscriptions call for prices.



Any advertising copy submitted for publication is deemed the property of the advertiser, and is used on the condition that all liability for copyright laws is the sole responsibility of the advertiser.

©August, 1990

## When You Buy Your Circular Saws From B.H. Payne – You've Bought The Best . . . We Guarantee It!

Here's What You Get With EVERY B.H. Payne Saw –

- Saws manufactured from only the Highest Quality Nickel Alloy Steel
- Each Saw Milled With State-Of-The-Art Precision CNC Milling Machine
- We Tension Your Saw to Your RPM **BEFORE** Leaving Our Factory
- Complete Guarantee of Your Satisfaction

**We Are Hanchett Distributors**

*We Manufacture & Sell Inserted Tooth Headsaws, Solid Tooth Saws, Inserted Tooth Cutoff Saws, Carbide Saws & Wide Band Saws. We Also Stock And Sell Bits & Shanks, Carbide Tips, Diamond Wheels, Knife Grinding Wheels, Saw Gumming Wheels, Knives, Babbitt & Babbitt Pots, "Lubie" Lubricants, Machine Parts for Various Filing Room Machines & More!*

**B.H. PAYNE & COMPANY, INC.**

P.O. BOX 90608, East Point, GA 30364  
404-761-8711 FAX 404-761-5398

*"Traditional Quality Combined With Today's Technology"*

**Call 800-752-0627**

Make Sure To Ask For Our Free, Complete Saw Catalog



See Us At:



May 20-21  
Booths 427-429

www.paynesaws.com

# Saw Filing Solutions!

## Keep Your Saws and Knives Dialed In and Reduce Downtime



**Bandsaw Stretchers**  
Sgl. or Dbl. Cut Bands  
Up to 14" Wide.



**410 Sharpener**  
For 2"-10" wide  
bandsaws. Shown  
with linear slide.



**Most Accurate on the Market!**  
Available in 48", 60", 84" & 100" capacities

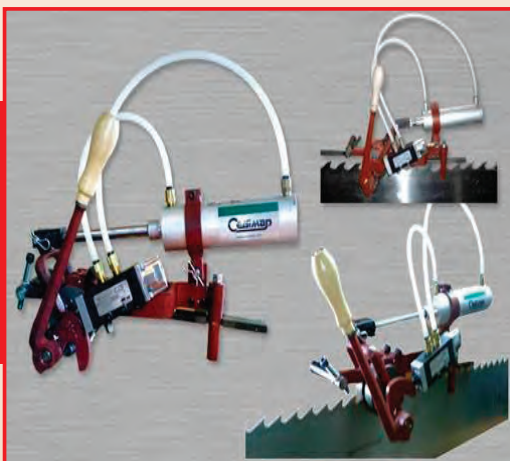

**Air & Manual Swages**



**Jockey Grinder**



**Knife Grinding Systems**  
— All Types



  
**MADE IN  
USA**



**HANCHETT**  
MANUFACTURING, INC.  
**800-454-7463**  
**231-796-7678**

www.hanchett.com • E-mail: ralphm@hanchett.com  
"Serving Saw Filers for Over 100 Years!"

# It's a McDonough.



**edgers . resaws . band mills . carriages  
gangs . material handling**

See Us At:  
 **EXPO**  
Richmond  
May 20-21  
Booths 624 & 723

**[www.mcdonough-mfg.com](http://www.mcdonough-mfg.com)  
(715) 834-7755**





# Quality Precision Production

UDDEHOLM  
WOOD BANDSAW STEEL

Send Us Your Bandsaws For REPAIR and SHARPENING Service!



**Minnesota Saw Works**  
1-800-757-4446 • www.mnsaw.com



Barn Cleaners

Stake Pointer



Blowers

Sawmill Equipment  
Lumber Equipment  
Pallet Equipment  
Material Handling



800.233.0471

717.354.4348

www.Pendu.com

## Need Conveyors? We've Got You Covered

Move Chips, Sawdust, Mulch, Bark and almost any Wood Byproduct Quicker and Easier!





**CONVEYORS**  
870-269-8788

**Competitively Priced!**

Call us today to place your order!



**OZARK INDUSTRIAL COMPONENTS**

Toll Free: 877-266-8202  
Local: 870-269-8788  
www.ozarkindustrial.com  
Inquiries@ozarkindustrial.com

## Cresswood Delivers



## Pallet Recycling Solutions

American-Made Quality & Innovation  
From the Industry-Leader in Pallet Recycling







55 W Lincoln Hwy, Cortland, IL 60112    [www.cresswood.com](http://www.cresswood.com)    800-962-7302

## BUYING LASERS?

Ours are more economical, more precise, last longer and give you better visibility.  
*What more do you need?*

---

Compare our **ELD-15 (Red)** & **EGL Series (Green)** to the others...  
*You'll choose Ellison and Save Money!*

## ELLISON SALES

1-888-244-0161  
dan@ellisonsales.com  
www.ellisonsales.com

## USED EQUIPMENT

We own what we advertise!  
New Equipment Arriving Weekly



WE TAKE TRADE-INS

866-546-8864  
[www.prrgroupinc.com](http://www.prrgroupinc.com)



Nicholson A5 35" Debarker  
See complete inventory at  
[lps-inc.com](http://lps-inc.com)

800-598-3651



### Building Block Pallets? Need to Reduce Costs?

We now offer 3 sizes of extruded wood blocks:  
3"x3", 3.5" x 3.5" and 3.5" x 5.5"

Made in USA  
**Litco International, Inc.**  
866-522-6342  
[www.litco.com/wood-blocks](http://www.litco.com/wood-blocks)



Consistent quality, High impact resistance

## WIDE Bandsaws

Made by life long saw filers  
4-8" wide (Sgl. & Dbl. Cut)  
1 3/4" - 2" tooth space

BARTLETT'S SAW SERVICE & SUPPLY  
800-566-0319

## DOUBLE NOTCHER



- High production
- Hopper feed
- Indexable replaceable tip cutters
- 28 in. -76 in. stringer capacity standard
- Unscramble infeed ensures quick feeding of stringers
- Table top hand crank adjustment raises and lowers to allow of depth of notch from 0 to 3 in. standard



800.548.6914    573.663.7711    [baker-online.com](http://baker-online.com)

## Dry Kiln Fan Blades

Available Now For Your Dry Kiln  
➔ **Better Blades at Better Prices**

We have the expertise & experience to make your kiln run better.



Distributor for:

- Smithco Propellers
- A.O. Smith Harvestore

## LeeCo

Pelham, AL • [tw135124@yahoo.com](mailto:tw135124@yahoo.com)

Call Now **205-663-5065**

— We Rebuild Bottom Chain Unloaders —

# Industry's Most Trusted Source



GW SYSTEMS RADIAL LOG CRANE



MORBARK 48" BIG THROAT CHIPPER



YATES AMERICAN A20-12 PLANER



HURDLE 2 HB SAWMILL



PRECISION CHIP SCREEN



UNSCRAMBLER



ACTION VIBRATING CONVEYOR



HURDLE 3 HB SAWMILL



LIGNA 2-SAW EDGER

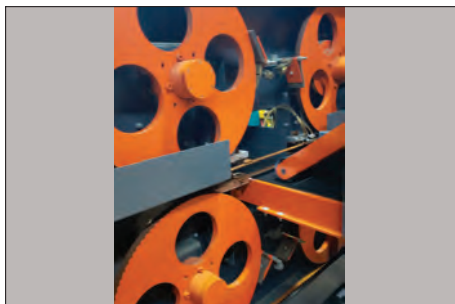

WOOD-MIZER 2-HEAD RESAW



HOLTEC PACKAGE SAW



BREWCO B800 GRADE RESAW



NORTHTECH GANGRIP



CORNELL 5-SAW MULTI-TRIM



WSM HORIZONTAL WOOD HOG



LIGNA 64' LOG TROUGH



WOOD-MIZER TRANSFER DECK



CORLEY 180 DEGREE TRANSFER



REBUILT PRECISION CHIPPER



NEW PRECISION CHIPPER



## Ben Jones Machinery

Div. of Dickert Enterprises, Inc.

Industry's Most Trusted Source



\*\* Financing Available \*\*



# 706-575-1534

sales@benjones.com

Don't See What You're Looking for Here? Search Our Complete Inventory at [www.benjones.com](http://www.benjones.com)



**THE PALMATE GROUP**  
PERFECTING PROCESSES  
PalMate ERP • Plant Floor • PalMate Portal • PalDraw

## Dedicated to Providing Your Team...

---

- Solutions To Simplify What Matters
- Advanced Technology Tailored to Your Industry
- Over 20 Years Experience Helping Transform Pallet & Timber Operations

See Us At:  **EXPO Richmond**  
May 20-21  
Booths 212 & 311



Your Partner in Perfecting Processes

www.ThePalMateGroup.com

---

Automated Machine Systems | 877-267-8384



## KILGORE SAW COMPANY

### Thin Kerf Band Saw Blades

✓ Check Out Our . . .

- Quality
- Service
- Dependability
- Price

See why we are your best source for bandsaw blades!

Satisfaction Always Guaranteed

 Toll Free 

## 1-888-857-5153

E-Mail: kilgoresawco@yahoo.com

**PALLETS FOR SALE**

48X30  
41X37  
Trl loads

617-592-5799

**Silvatech Sales & Service**

For service or for Refurbished Parts on your Silvatech Computers, call McKenzie Sawmill Service!

---

Call David  
256-862-9307

**FRICKCO, INC.**

We manufacture & sell parts for Frick sawmills. We also sell new Frickco sawmills.

Call for your nearest dealer.

740-887-3799

South Bloomingville, Ohio

HOG PARTS

For Your Montgomery & Jeffrey Hogs!

1-888-244-0161  
www.ellisonsales.com

(Other Brands Also Available) → Don't Wait... Call The Hogman!

**HMC V-2110 LOG DEBARKER FOR SALE**  
Brand New—Never Installed!

8"- 48" diameter, 28' max length  
16" head w/56 teeth,  
60 HP motor

Hydraulic Rotation & Auto Lube System  
5' x 6' Sit Down Operators Cab  
Located in Northwestern PA  
Call 814-697-6576  
For More Information.

**RETIRING – FOR SALE**

6 X 30 OLIVER PLANER.....	\$5,000
4 X 6 VONNEGUT MOLDER.....	\$2,000
BAKER MODEL A RESAW.....	\$9,500
5 HP TORRIT-BLOWER/CYCLONE.....	\$1,300
18 HP DUSTER BLOWER/BAG.....	\$1,500
IRVING POP UP SAW W/STOPS.....	\$900

CALL 518-439-7289

518-322-2927 - 518-496-7960

# Meadows Edgers—Designed to fit YOUR Specific Needs.

We've sold over 12,000 edgers because we listen to our customers. All are built with the same Meadows quality that withstands every test. From smaller portable models to our heavy duty combination edgers, you'll find one to fit your requirements.

## Combination Edgers

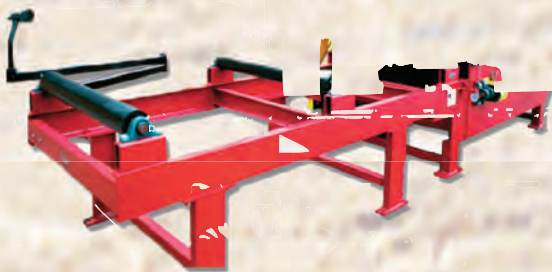

Spartan 6"

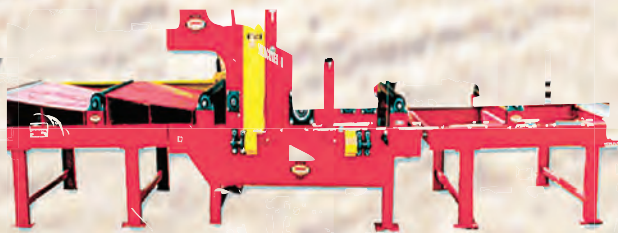

Trojan 7"



Hercules 8"

- Frame widths available in 36", 42" and 48"
- Solid steel side plates with door for easy saw changes
- Made in USA
- Lots of optional equipment available

**HERCULES 8.5" cut depth**  
**TROJAN 7" cut depth**  
**SPARTAN 6" cut depth**

## Board Edgers



Standard 4"

- Handset or Hydraulic
- 30" & 36" Widths



Deluxe 4"

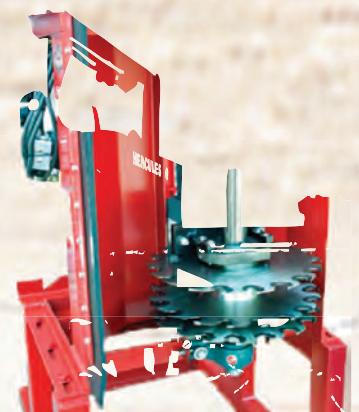

Vertical Edger



Miner 3-31

- Electric, Gas or Diesel
- 4" Max. Board Thickness



Miner Models A & B-53



Miner Portable

**Every Meadows Edger is customized to meet the exact needs of our customers.**

# MEADOWS MILLS, INC.

## 800-626-2282

Since 1902

*Meadows*  
North Wilkesboro, NC, USA

www.meadowsmills.com • sales@meadowsmills.com  
1352 West D Street • North Wilkesboro, NC 28659



# READY TO SAW WHEN YOU ARE

**FIND YOUR BLADE**

**FREE SHIPPING**

**FIND THE BEST BLADE FOR YOUR SAWMILL ONLINE**

**FREE SHIPPING ON SELECT BLADES**

**SAVE 15% + FREE SHIPPING ON 60+ BLADES**

**AVAILABLE DIRECT AUTHORIZED DEALERS BUY ONLINE**

**Ready to Ship**  
Select sawmill blades are in-stock and ready to ship, **many ship same day!**

**High Quality**  
Every sawmill blade is profile ground tip-to-tip, extensively tested, and thoroughly inspected.

**CELEBRATING 40 years SINCE 1982 Wood-Mizer**

**Wood-Mizer blades**

866.373.6533  
woodmizer.com/blades

©2022 Wood-Mizer LLC

See Us At:  
**EXPO**  
Richmond  
May 20-21  
Booth 719

**Air Systems Mfg.**  
OF LENOIR, INC.

## Let's clear the air...

*by discussing your dust, smoke, fumes and vapors.*

**Turn-key Project Management Services:**

- Trouble-shooting
- Written assessments
- Technical recommendations
- Conceptual and final design
- Manufacturing
- Custom installations
- New and reconditioned equipment
- Sales and support
- On-site maintenance

- **In Stock-Extensive Inventory of Reconditioned Equipment**
- **Maintenance Services Available for Filtration Equipment**

2621 Hogan Drive  
P.O.Box 1736 • Lenoir, NC 28645  
(828) 757-3500 • Fax (828) 758-5178

Check out our new website at:  
[www.airsystemsmfg.com](http://www.airsystemsmfg.com)

• Dust Collection • Air Filtration • Ventilation Systems  
• Custom/Standard/Reconditioned

## Jones Model CH4 Carbide Saw Grinder

**\$520**  
w/ Diamond Wheel  
AC or AIR

Headsaws, Scraggs, Edgers.

Inserted Tooth or Carbide Tipped.

Tension Release Lever assures easy movement around the saw, and an accurate grind every time.

Wear Pins rest on saw, not on tooth, to prevent chipping carbide bits.

**For a full line of AC, Air, Cordless and Flex-Shaft Grinders, Slasher Saw Grinders, Cordless Slasher Chain Sharpeners, Safety Pin Saw Wrenches, etc. Call 812-354-6981 or your local dealer.**

# GET YOUR EQUIPMENT FASTER FROM GO FAST!

## THIN-KERF RESAWS



**6X6 Master**  
Belt Return  
Single or Multi-Head



**6X8 Master**  
Manual Return  
Single or Multi-Head



**Master Grade Saw**  
16" Wide Cutting Grade  
Saw & Run Around



**DD79**  
High-Production  
DeDuster

## CUT-OFF SAWS



**TS10**  
Single-End Trimsaw  
10" 12", or 14" Blade



**DET-20**  
Double-End Trimsaw  
20" Blades



**MET-20**  
Multi-End Trimsaw  
20" Blades



**CS Series Chopsaws**  
Heavy-Duty Chopsaw  
24" OR 28" Blade

## FIREWOOD MACHINERY



**FWT-20**  
Firewood/Slabwood  
Multi-Head Trimsaw



**FWW-16**  
Industrial-Duty  
Firewood Wrapper

## NEW FROM GO FAST!

### HIGH SPEED NOTCHER



**2NXP**  
DOUBLE HEAD NOTCHER  
Automatic In-Line Notching System

## SPECIALTY EQUIPMENT

### Conveyor & Lift Table

Perfect Solution for Staging  
Material In-Front of Machines



**HD UNSCRAMBLER**  
Low-Profile Design  
Heavy-Duty Construction

## HAND-STACKING SOLUTIONS

### BOARD STACKING RACKS

Stack a Square Bundle  
Every Time!

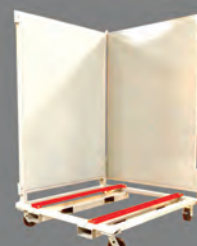

**POWERED ROUND TABLES**  
Adjustable Table Height

## GO FAST NOTCHERS



**NXL-M**  
Manual-Feed  
Single Head Notcher  
UP TO 540 STRINGERS PER HOUR



**NXL**  
Semi-Auto  
Single Head Notcher  
UP TO 800 STRINGERS PER HOUR



**Twin NXL**  
Semi-Auto  
Double Head Notcher  
UP TO 1750 STRINGERS PER HOUR



**2NX**  
High Speed  
Double Head Notcher  
UP TO 4000 STRINGERS PER HOUR

**MADE IN  
WISCONSIN**

**1-800-854-7439  
WWW.GOFASTMFG.COM**

**FLEX-FINANCE AVAILABLE!**



# When Your Mill's Performance Counts... Count on Alderman's Saw Shop!

For over 51 Years, we've supplied sawmills with New bandsaws and carbide saws — *whatever they need to keep their mills running right!*



Carbide Saws

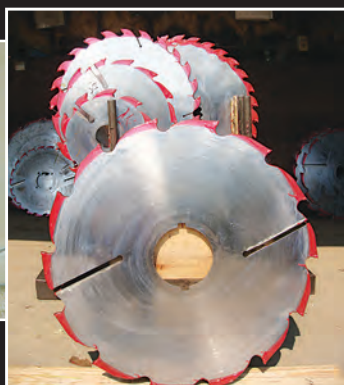
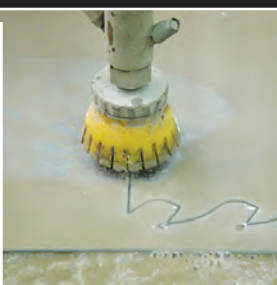

Uddeholm Wide Bandsaws — Made in Virginia

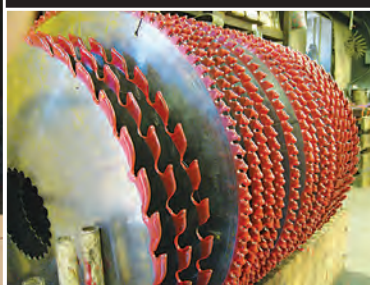

Distributor for  
Lubie Industrial Lubrication Systems  
& Norpac Quick Change Saw Guide Systems

e-mail: [info@aldermansawshop.com](mailto:info@aldermansawshop.com)  
[www.aldermansawshop.com](http://www.aldermansawshop.com)

Call Us! **1-804-333-4895**

## The Most Durable, Smoothest Operating Cut-off Saws Available!

### Pneumatic Saw

Cushioned  
Air Cylinders  
2" x 24" cutting  
capacity



**Your Choice...**  
Pneumatic or  
Mechanical

### Versatile!

#### Uses include:

- Producing cut stock for pallet operations
- As defecting saws for woodworking/flooring
- Cutting finished components for cabinetry

Available in  
cutting options of  
2" x 8", 2" x 12"  
and 4" x 8"

Available in  
left or right hand

### WE SELL

- ✓ SC Industrial Finger Jointer & Cut Off Saw Parts
- ✓ After-Market Precision Cut Off Saw Parts
- ✓ Crosscut Solutions Saw Parts



### Crosscut Solutions, Inc.

E5763 County Road B • Manawa, WI 54949  
Ph: 920-596-2330 • Fax: 920-596-2324  
[crosscut@wolfnet.net](mailto:crosscut@wolfnet.net) • [www.crosscutsolutionsinc.com](http://www.crosscutsolutionsinc.com)



### PRECISION-BALANCED HOG ROTORS

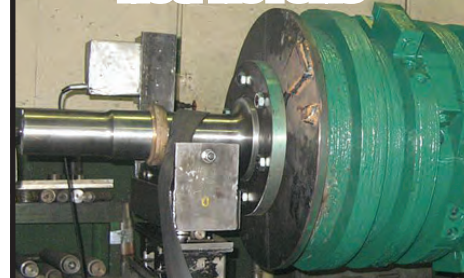

ELLISON SALES, INC.  
Toll-Free: 888-244-0161  
[dan@ellisonsales.com](mailto:dan@ellisonsales.com)



## Dismantling BARS

"LIFETIME WARRANTY"  
from...

**PRIS**  
PALLET REPAIR SYSTEMS, INC.  
Pallet Repair Systems, Inc. • 3550 Mayflower Blvd. • Springfield, IL 62707  
PHONE: 217.291.0009 FAX: 217.291.0008  
TOLL FREE: 866-546-8864 [www.pallet-repair.com](http://www.pallet-repair.com)



# WOOD PALLET TRASH SOLUTION

REPURPOSE WOOD CRATES  
SUSTAINABLE/RESPONSIBLE



**AUTOMATE SCRAP  
HANDLING**

**NO LANDFILL  
LOWER CARBON FOOTPRINT**



See Us At:  
  
**EXPO**  
 Richmond  
 May 20-21  
 Booth 731

**TURNKEY SERVICE — ONE-STEP CONVERSION**

**BOULWARE EQUIPMENT, LLC**

3134 Pinkie Lane, Newton, NC 28658  
 PH: (704) 651-6061 • [brad@boulwarellc.com](mailto:brad@boulwarellc.com)

# Solid production without breaking the bank

See Us At:



**EXPO**  
Richmond  
May 20-21  
Lots J1 & 17

Quick, easy installation

50 years of engineering design

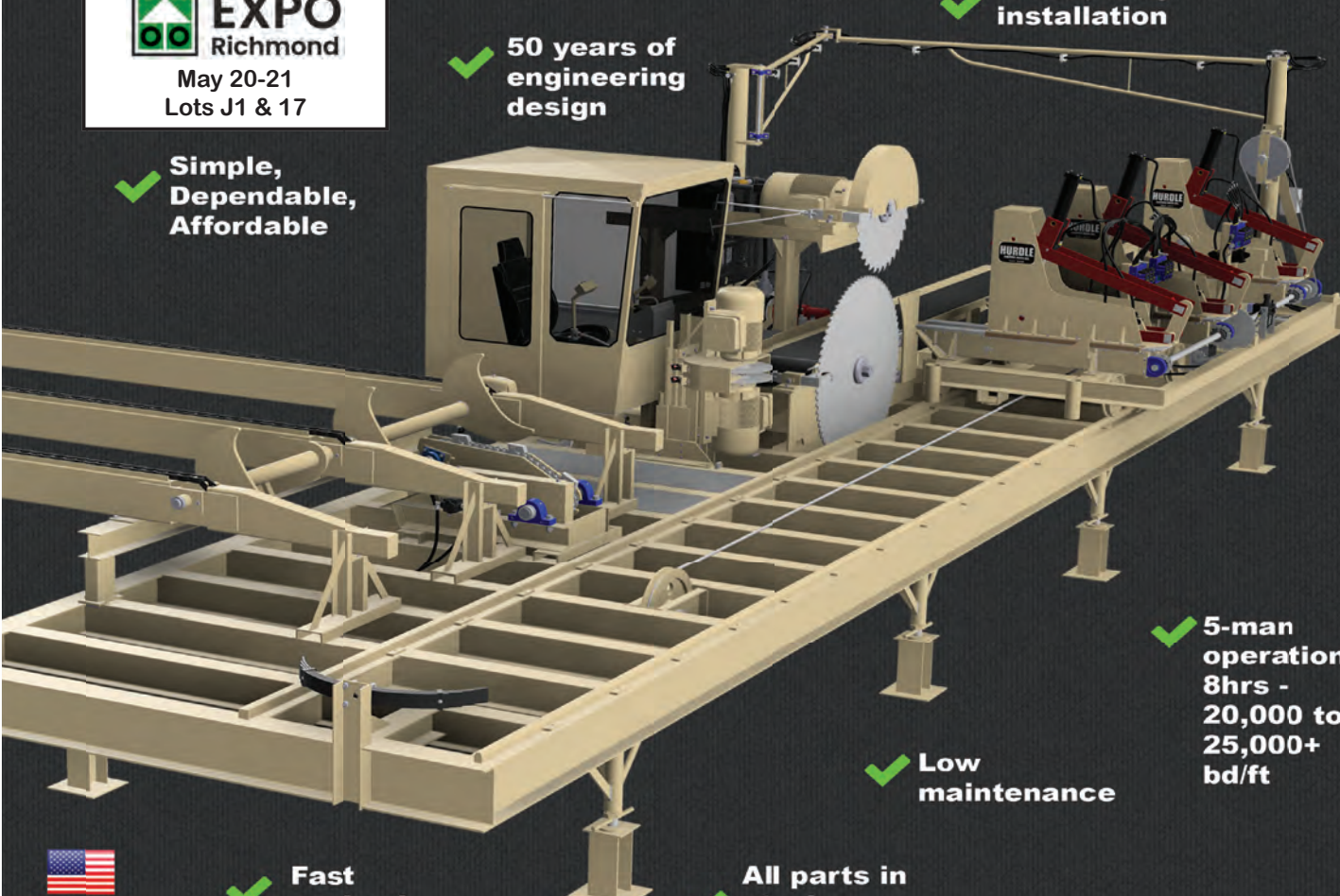

Simple, Dependable, Affordable

5-man operation  
8hrs -  
20,000 to  
25,000+  
bd/ft

Low maintenance

Fast payback

All parts in stock - ready to ship

3-week build time! Take advantage of hot markets without taking on massive debt.

 MADE IN Moscow, TN USA



You Tube [www.youtube.com/HurdleMachineWorks](http://www.youtube.com/HurdleMachineWorks)

[www.hurdlemachineworks.com](http://www.hurdlemachineworks.com)

f [www.facebook.com/HurdleMachineWorks](http://www.facebook.com/HurdleMachineWorks)

**CALL US NOW!**  
901.877.6251



**NEW MDI METAL DETECTOR**  
Ready to ship from our shop in Georgia!



**Ben Jones Machinery**  
Div. of Dickert Enterprises, Inc.  
Industry's Most Trusted Source  
**800-241-8983**  
See more equipment at [www.benjones.com](http://www.benjones.com)

### Your Cut Stock Source



- Panel Cut Stock/CNC
- SYP Cut Stock
- Band Groove

[www.SomersLumber.com](http://www.SomersLumber.com)  
**(704) 500-2990**

Now offering Common Carrier Services

SOMERS LUMBER MANUFACTURING, INC. Union Grove, NC

### Live Floor Belt & Chip Trailers

From Pickup Truck Beds to 53'



**BUY • SELL • RENT • NEW & USED**

Full Repair Service & Parts for Keith & Halco Wet Kits, Hyd. Pumps, Valves, Hoses & More.



800-326-4919 • Cell 574-453-7120  
[www.fergusonfarms.com](http://www.fergusonfarms.com)

## Row Electrical Equipment, Inc.

P.O. Box 2812 • Toledo, Ohio 43606

**Your Source for Used & Reconditioned:**



- Squirrel Cage Motors
- Gear Motors
- Wound-Rotor Motors
- Synchronous Motors
- DC Motors
- Phase Converters
- Adjustable-Speed Drives
- Generators, AC and DC
- Engine-Generator Sets
- Transformers, Single Phase
- Transformers, Three-Phase
- Across/Line
- Reduced Voltage Starters
- Safety Switches



24 Hours a Day Call **800-248-4479** • We Buy Used Electrical Equipment  
Visit our website: [www.rowelectrical.com](http://www.rowelectrical.com) • Email: [sales@rowelectrical.com](mailto:sales@rowelectrical.com)

CEMARLIGNE

## NEED A LASER?



**SEE PAGE 53...**

**CEMAR ELECTRO INC.**  
THE LEADER IN LINE LASER TECHNOLOGY

# Firewood Production—Your Needs, Your Choice!



**Model 1610EZ**  
Joystick control, diesel, live deck, ultra mobile with integrated conveyor.

See Us At:  
 **EXPO**  
Richmond  
May 20-21  
Outside Lots B4-7

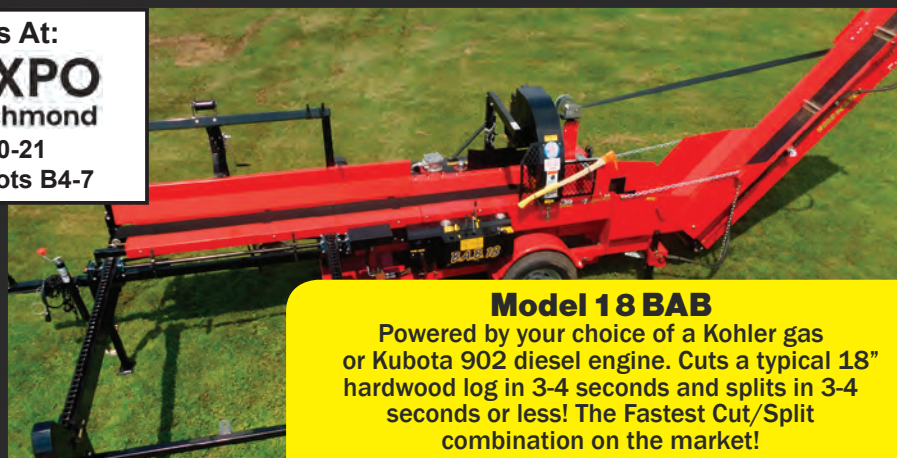

**Model 18 BAB**  
Powered by your choice of a Kohler gas or Kubota 902 diesel engine. Cuts a typical 18" hardwood log in 3-4 seconds and splits in 3-4 seconds or less! The Fastest Cut/Split combination on the market!



**Model 2040xp2**  
The Premier High Volume Firewood Processor



**Lil Beaver 14**  
• 1 Cord Per Hour • 13hp Honda Gas  
• 10ft Max Log Length • 16in Max Log Diameter

Wood Beaver™ Equipment Manufactured by

Prentice, WI 54556-0170 USA



**800-243-5438**

e-mail: [sales@multitekinc.com](mailto:sales@multitekinc.com)

[www.multitekinc.com](http://www.multitekinc.com)

**We Manufacture Short Studs & Pallet Cutstock**

KD HT HF/DF/SPF 1x4, 1x6, 2x4, 2x6  
Any length Cutstock. Flatbed delivery.

Also: Green 1x4, 1x6 MRR

Call **1-800-447-3792**

e-mail: [tjforest@gmail.com](mailto:tjforest@gmail.com)

Nampa, Idaho



**NEW WEBSTER VIBRATING CONVEYOR**



**Ben Jones Machinery**

Div. of Dickert Enterprises, Inc.  
Industry's Most Trusted Source

**800-241-8983**

See more equipment at [www.benjones.com](http://www.benjones.com)

**COMPLETE SCRAGG SYSTEM**

**\*\*PRICED TO SELL!\*\***

office (304) 478-2500 ext.111

[sbolyard@hinchcliffproducts.com](mailto:sbolyard@hinchcliffproducts.com)

Hendricks, WV



TIPTON IRON WORKS TRIMSAW



TIPTON IRON WORKS TRIMSAW



TIPTON IRON WORKS HORIZ SAW



TIPTON IRON WORKS LINEBAR SAW

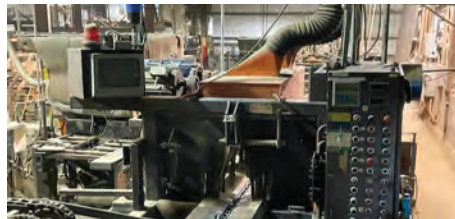

TIPTON IRON WORKS QUADSAW



TIPTON IRON WORKS EDGER



5' x 60', 5 Strand Chain Conveyor

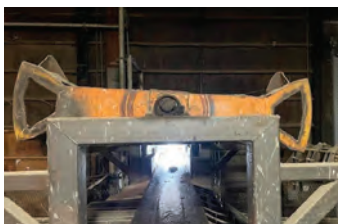

(3) Electric Kickers, 6' Diameter, 6' Long



52" X 84' Inclined Belt Conveyor, Bed pan approximately 15 feet high off the ground

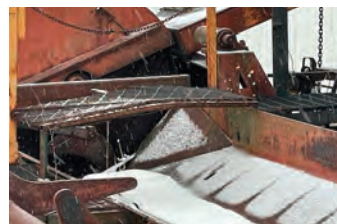

Log Cut Up System

# WHY WAIT FOR NEW? **BUY USED – SAVE TIME & MONEY!**



**2016 Fulghum Rosser Hd Debarker**



**Cooper 16' EndDogging Scragg**



**Cambio 30" Ring Debarker**



**HMC AC50 Modular Carriage w/Pinheiro DBL Cut Band Head Rig**



**Newman 382 Helical Head Planer**



**Dual Trailer Loading System**



**Brewer Step Planer**



**Morbark Stac Trac**



**Progressive SBD/D-31 Gang Rip Saw**



**Canadian Car Chip-N-Saw**



**Pendul Stacker**



**Hazelthorn Triple Dismantler**



**New PRS Destubber/Sizer**



**Baker Model B36**



**Nicholson A5 22" Ring Debarker**



**Bandit 2590s Disc Chipper 200HP**

**LIKE NEW!**



**HMC LH 16' MDS50 Drop Saw Trimmer**



**G-Tek Grade Resaw System**



**90° Radius Transfer Deck**



**Morbark 58" Wood Chipper, Cyclone & Chip Screen**



**Complete Automated Bagging Line**



**Brewco 2 Saw Edger w/Tailing System**



**Cresswood EF 3660D Slow Speed Grinder w/ Vibrating Infeed**



**Lane Diesel Powered Modular Mill**



**Progress 84" Chipper**



**Complete Smetco Sorting Line**



**Roto Chopper EC124 Grinder**



**Meadows 3HD Block Modular Mill**



**Hamer Auto Bagger**



**Air Compressors 5hp - 200hp**

**LPS** EQUIPMENT & ACQUISITION CO.  
731-986-4351 | sales@lps-inc.com

**Call 800-598-3651**  
**WWW.LPS-INC.COM**



# WHY WAIT FOR NEW? *BUY USED – SAVE TIME & MONEY!*



**Nicholson A5 35" Debarker**



**McDonough 54" Center Split**



**Progress 8'x16' Screen**



**Nicholson 44" Ring Debarker**

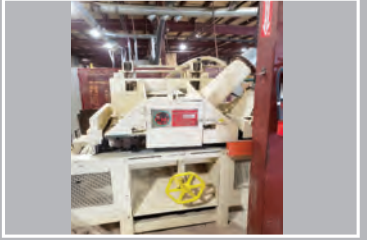

**Mereen Johnson 312 Rip Saw**



**Several Waste Conveyors**



**John Deere 648G Grapple Skidder**

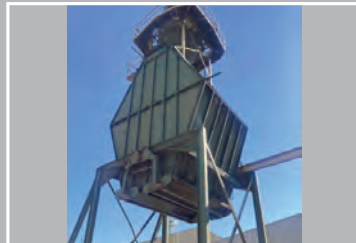

**Several Chip Bins**



**Salem Hog**

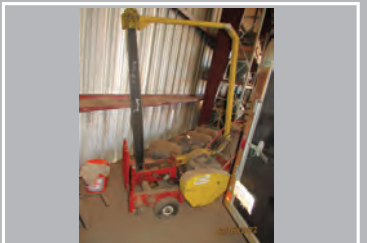

**Portable Package Saw**



**Helle 3-Saw Vertical Edger**



**8'x30' Drum Dryer Gas Fired**



**Precision 48" 6-Knife Chipper**



**Step Feeder**



**Viking Sentinel Nailer**



**L & M Slasher Saw**



**Brewer 3-Saw Multi-Select**



**Morbark Wood Hog**



**Truck Dump**



**Montgomery HD 26 Blow Hog**



**Walking Floor Bin**



**Brewer 9124 Gang**



**Frick 4-Head Block Carriage**



**Several Bronco Nailers**



**Several Cabs**



**Several Log Troughs**



**Holtec Package Saw**



**Several Smetco Pallet Stackers**

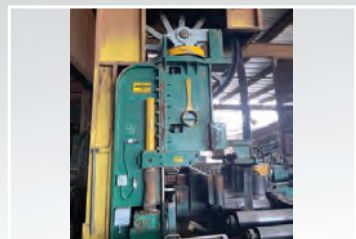

**Salem 6' Band Head Rig**



**Magnum Cheetah 4 Stringer Nailer With Stacker**



**Several Dust Collectors**



**Smetco Pallet Tipper**



**Matawoc Flail Debarker**



**Several Tilt Hoists**



**Hurdle 2HB Portable Mill**

# HMC Trimmers – Options For Your Needs

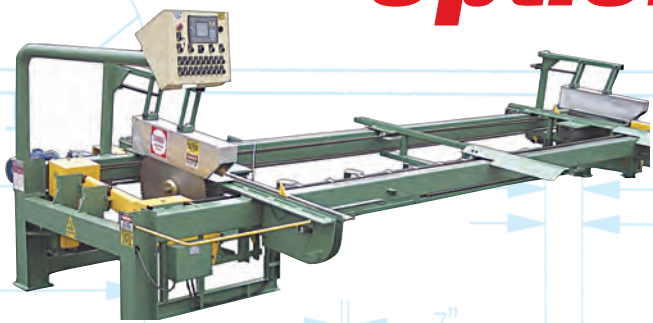

## ET10 Two Saw Trimmer

- Ideal for small to medium production mills
- End trim lumber, cants and ties up to 9" thick
- Available in hydraulic or *High Speed Electric*

*Quality Sawmill Equipment Since 1953*

See the MDS50 on display at the



**EXPO**  
Richmond

May 20-21  
Outside Lots  
K7, 8 & 16



## MDS50 Drop Saw Trimmer

- Ideal for medium to high production mills
- End trim multiple thicknesses
- Loaded with standard features for maximum production and safety
- Proven — *an industry favorite*

*Call us today to explore your options and increase productivity.*



**603-746-4691**

284 Maple Street • Contoocook, NH 03229

Fax: 603-746-4819

[www.hmccorp.com](http://www.hmccorp.com)

[info@hmccorp.com](mailto:info@hmccorp.com)

## VIBRATION RESISTANT HIGH IMPACT

Works with IP PoE Networking, HDTV and Coax Analog



CC02 & CC04 Cameras

### ALSO AVAILABLE

PTZ & Bullet Cameras



CONTACT OR VISIT US AT

**800.578.1853**  
[opticomtech.com](http://opticomtech.com)



## The Original Patented Jackson WOOD SHAVING MILL ...Since 1960!



- Single or Double Box Machines
- Several Models to choose from producing 7.4 Cubic Yards (5.7 Cubic Meters) to 50 Cubic Yards (38.2 Cubic Meters)
- Utilize low-grade Logs & Slabs
- Produce high-quality, fluffy shavings
- Powered by Electric, Diesel or Tractor PTO
- Complete wood shavings plant layout services available
- Shavings Drying Systems ...featuring Webb Solid-Fuel Burners



Where Ideas Are In Production

**(715) 926-3816**

[www.JacksonLbrHarvester.com](http://www.JacksonLbrHarvester.com)

# 100% AMERICAN-MADE BULK PALLET NAILS



**We Manufacture  
& Sell All Sizes!  
Also Coil, Ring Shank  
& Screw Shank**

**LET US KNOW  
WHAT YOU NEED.  
WE WANT TO BE  
YOUR SUPPLIER.**

**www.michiganfastener.com  
Michiganfastener@outlook.com  
810-728-4005**

**A Family Owned  
& Operated Business**

**Save 10-25%**  
on your monthly  
saw blade purchases  
by using Lubie®

**BIOLUBE**

The home of Lubie® saw lubricating systems and Lubie lubricants.

**www.biolube1.com • 260-414-9633**  
email: sales@biolube1.com

**BANDSAW BLADES**  
We have the most popular sizes in stock & ready to ship from major manufacturers, including...

**LENOX**  **Wood-Mizer Blades**  
Your Leader in Blade Technology.

**Welded to your lengths!**  
We also offer expert Sharpening Services, plus...

Gang • Edger • Scragg  
Trim • Split • Strob  
...and just about any Custom Saws you need to keep you cutting longer...for less!

Call Marvin Miller for a quote  
231-924-5953 (fax) 231-924-6166

**MIDWEST**  
SHARPENING SERVICE

# IN STOCK - Priced to Move!



Self Centering Infeed w/ Electric Drive

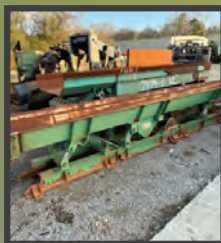

Millpower Coil Spring Conveyor 20' - \$7,900



48" Morbark 6K Chipper



6x6 Bush Screen Ready To Run - \$6,500



6x16 BM&M DCF High Volume Screen



New 66" Precision Chipper Available- Top or Bottom Discharge



Acrowood Slant Disc Chipper



Jeffrey 44 Hammer Hog w/ Hopper & Motor



48" Soderhamn 6K Rebuilt



Mulch/ Sawdust Bagging System- \$9,500



96" Precision 4K Chipper



58/60" Precision HD Chipper



### READY TO SELL:

- 64" Belloitt Chipper - \$3,900
- 75" Fulghum Chipper - \$12,000
- CME Bent Knife Grinder - \$1,500
- Remanufactured Blower - \$2,500
- 58" Large Mouth Soderhamn 6K
- 60" Progress 6 Knife Chipper as is \$9,500
- 48 Soderhamn 6 Knife
- 48" Precision 3 Knife
- 48" Fulghum Chipper
- 48" Morbark Chipper
- 58" Morbark Chipper

info@woodlandpartsinc.com • www.woodlandpartsinc.com  
(800)-726-0188 (256)-362-5097

## MONTGOMERY INDUSTRIES INTERNATIONAL

2017 Thelma Street • Jacksonville, Florida 32206  
Ph> 904.355.5671 • Fax> 904.355.0401  
www.montgomeryindustries.com

Since 1925



25 years of service

After factory rebuild

Bring new life to old equipment!

### High Performance Hog Parts

- ✓ New and Repaired parts
- ✓ All the parts you need to keep your hog running
- ✓ Full Rotor Assemblies
- ✓ Complete Hog Rebuilds

### PEERLESS DUMPER



s/n 1PLNO3528X-PD20293, 35/Porto Dumper, 50 ton, 5-99...  
\$115,000  
Call 225-343-9674 (LA)

### Amerimulch Mulch Coloring Machine



Call Rachel  
(931) 797-6284

## AMERICAN WOOD FIBERS

Buyers of sawdust & shavings

Call for more information

Miles VanSike 800 967-4789

Email: mvanskike@awf.com

Flexible service options—Reliable & Prompt



# Your Most Reliable Source for High Quality Used Equipment See Our Entire Inventory at [www.palletmachinery.com](http://www.palletmachinery.com)



Eagle Tandem Pallet Nailer #2498

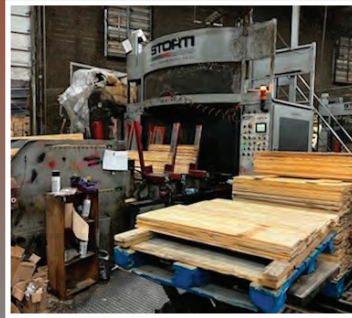

Storti GSI 61/62 Tandem Nailer Stringer Pallet Line #2794



Viking Sentinel #2763



2000 GBN Excalibur #2222



Senstar 3-stringer Pallet Nailer #2759



Pallet Chief w/ Stacker #2801



Tilt Hoist #2769



Tilt Hoist Infeed Deck #2768



Diehl Straight Line Rip Saw #2758



Pellet Bagger w/Hopper & Sealer #2776



2022 GoFast Deduster #2800



Bronco Dismantler #2772



Indus. Resources Sorting Line w/pallet tipper #2756



Froedge Deduster #2779



Brewer Chamfer #2774



Morbark 58" Chipper #2744



Meadows Sawmill Deluxe #2787



Baker 6-head Resaw #2792



Timberland Deduster #2341



Trim Saw #2797

**Do you have quality used equipment to sell? Contact PMG to help get it SOLD!**



**(540)-644-9220**

E-mail: [info@palletmachinery.com](mailto:info@palletmachinery.com)

[www.palletmachinery.com](http://www.palletmachinery.com)

**Shavings Mills - Shavings  
Re-Sizers - Conveyors - Dryers**



Shaving Mills are available both Portable or Stationary With a blower or Conveyor Drop. PTO Driven - Diesel Engine Driven - Electric Driven  
 12" PTO = 9 Cu. Yds. Per Hour    40" = 28 Cu Yds. Per Hour  
 20" = 14 Cu. Yds. Per Hour    60" = 45 Cu. Yds. Per Hour  
 30" = 21 Cu. Yds. Per Hour

**www.salsco.com**

MADE IN THE U. .A.

**PTO Wood Chippers! Gravity or Hydraulic Feed! 3-1/2" to 10" Capacity!**



Salsco has the most extensive line of PTO Chippers on the market today. We offer 3-1/2", 4", 6", and 10" capacity options, Gravity Feed or Hydraulic Feed. Speed Sensing option is available on all Hydraulic Feed units. Pictured are examples of some of the PTO Chippers that Salsco has to offer.

**Slab Chippers - Sawdust Producing  
Machines! SC-12 & SC-18**



- Belt Drive to Cutter Head
- Variable Speed Hydraulic Drive to Feed Wheels
- Speed Sensing/Auto Feed Counts Cutter Head RPM
- Material Exit Conveyor

**MODEL SC-12**

- \* 12 Blades - 1/2" Thick
- \* 4" x 24" Infeed Opening
- \* 2 Upper & 1 Lower Feed Rolls
- \* 74.5HP Hatz Diesel

**MODEL SC-18**

- \* 18 Blades - 5/8" Thick
- \* 6.5" X 24" Infeed Opening
- \* 3 Upper & 2 Lower Feed Rolls
- \* 120HP Perkins Diesel Engine

**Turn Your Surplus  
Equipment Into  
CASH**  
 We pay top dollar for  
 good used equipment.

Go to our website for an  
 up-to-date listing  
 or call us at  
**800-241-8983**



**Ben Jones Machinery**  
 Div. of Dickert Enterprises, Inc.  
 Industry's Most Trusted Source

**UPDATED DAILY!**  
 www.benjones.com  
 E-Mail: sales@benjones.com

**WANTED TO BUY**

- Used Deck Boards & Stringers, 40" thru 44" L, 2 Ways or 4 Ways, Can Buy Multiple Lengths
- 48 x 42 Pallets
- Line Bar Shims
- Cross Tie Siding

**FOR SALE**

- Used 36" Deckboards
- CUTSTOCK  
FOR SALE**

Stringers & Deckboards

**Elora Pallet Shop**  
 Elora, TN  
**931-469-5558**

**Put these dates on your calendar. Come see us at the following shows:**

- Northeast Forest Products-2022, May 6-7, Essex Junction, VT
- Richmond Expo-2022, May 20-21, Richmond, VA
- Ag Progress Days-2022, August 9-11, Pennsylvania Furnace, PA
- Woodsmen's Field Days-2022, August 19-21, Boonville, NY
- Paul Bunyan-2022, October 7-9, Cambridge, OH
- Sunbelt Ag Expo-2022, Moultrie, GA

Scan or click here for more information on these Trade Shows.



**Salsco, INC.**  
 LEADER BY DESIGN

800-872-5726  
 105 Schoolhouse Road, Cheshire, CT 06410

**Reduce Downtime —Keep Your Mill Running at Peak Production!**

**Count on Brown For Low Prices,  
Quality Parts and Superior Service.**

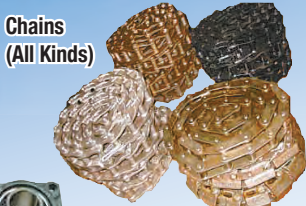

**KEEPING YOUR OPERATION RUNNING SMOOTH FOR OVER 50 YEARS**



**Brown Machinery and Supply, Inc.**

800-748-9801  
 Fax: 870-246-8044  
 www.brownmachinery-supply.com  
 P.O. BOX 9, ARKADDELPHIA, AR 71923  
 mike@brownmacsupply.com

# Sawmill Sensors

**Blast Through  
Steam, Fog, Grease, & Dirt**



- **Start and Stop Equipment**
- **Detect levels in bins and stackers**
- **Overcome Sawdust, Fog, Vibration, Dirt, Grease, and Steam**
- **Reduce Maintenance Time and Cost Using Diagnostic Tools**

## 1-800-211-9468

## www.pantron.com



- **Through-beam range up to 230 feet**
- **Waterproof - IP67 rated**
- **Not affected by vibration**
- **60k LUX immunity to sunlight**
- **Easy to install**

FUNCTIONALLY AND AESTHETICALLY NEW

# TRIM & GANG SAW REBUILDS AT 50% SAVINGS

*Fast Lead Times and Custom Options*

- ✓ Often Machines Available Now
- ✓ Customizable for Your Operation
- ✓ Guaranteed Highest Standards
- ✓ Standard Multi-Head Trimsaw Rebuild at Only \$85,000

**INCLUDES ALL NEW:** Bearings, Sprockets, Chains, 120V Controls, Belts, Blades, Safety & Dust Hoods, Wiring, Control Box with Many Options Available.

Trade Ins Considered - Call Today

## 205-620-4455

Connor Smith 205-601-0044  
csmith@smithcos.com

Phil Smith 205-910-7777  
psmith@smithcos.com



AFTER



BEFORE

bit.ly / SmithMachineWorx



Patchwood Products Inc. – Veteran Owned  
New Wood Pallets – Michigan – (989) 742-2605  
48 x 40 4 Way Pallets GMA - \$16 each – 2/tl available approximately 1,300 pallets  
Runners (3) 1 1/4 x 3 1/2 x 48  
Top (2) 1/2 x 5 1/2 x 40  
Top (5) 1/2 x 3 1/2 x 40  
Bottom (2) 1/2 x 5 1/2 x 40  
Bottom (3) 1/2 x 3 1/2 x 40

---

48 x 40 2 Way Pallets- \$13 each – 2/tl available approximately 1,200 pallets  
Runners (3) 1 1/2 x 3 1/2 x 48  
Top (5) 5/8 x 3 1/2 x 40  
Bottom (3) 5/8 x 3 1/2 x 40  
Pick up in Hillman, Michigan  
patchwoodplaza@frontier.com

**Safety Pin Saw Wrench**  
B-F or 2-1/2 \$79

3 style \$89

**Stainless Steel Tooth Stop for Jones Longhorn or Jockey \$42**  
**S.S. Reversible Tooth Rest \$16**  
Tooth Rest last 4 times longer.  
Call Randy @ 812-789-3448

**WANTED**  
1" x 6" 16' Poplar  
Bandsawed or Gangsawed  
**606-528-9729**  
Corbin, KY

## Every Reputable Wide Band Supplier Offers...

- ✓ High Quality Swedish Steel
- ✓ 3" - 8" Band Width
- ✓ 16 to 20 Gage
- ✓ Double Cut Options
- ✓ Choice of Swage or Stellite

See Us At:  
 **EXPO**  
Richmond  
May 20-21  
Booth 712

**BUT ONLY THE WOLVERINE BY MENOMINEE SAW GUARANTEES...**

- Cutting Edge Plasma Welds
- The Industry's Highest Cutting Capacity Band Saw
- Quick Delivery from our HUGE Inventory
- Fast Sharpening & Exchange Program to Keep YOU Running
- Competitive Pricing

And **ONLY** Menominee Gives You Everything You Need in a Wide Band Saw - Plus Expert Service from the Industry's Most Knowledgeable Staff.

**Got a Wide Band Problem?**  
Call Menominee Saw Today and You'll Learn Why More Mills Trust the Pros!



**TOLL FREE**  
**1-800-582-0470**

**WWW.MENOMINEESAW.COM**

Email: info@menomineesaw.com

## More Top Dollar Selling Options Available Than Ever Before!

Sell Your Way Fast!  
One Piece or An Entire Operation!

### NEW! Monthly Online Auction

- ✓ A Bright Star auction consistently delivers more bidders & the highest price
- ✓ Bright Star's promotional campaign is unmatched by any!
- ✓ Our professionalism in conducting auctions sets the standard!

So when you absolutely must have top dollar at your sale — DO THIS:

**CALL**

Zach Kittrell (Lic #1959) • 931-224-0699  
Need A Marketing Consultant?  
Call Jackie Kittrell (Lic #2293) • 931-698-3342

National Industrial Auctioneer



# SMART PRODUCTS

*Is Your Answer! For Pallet Lumber Recovery and Repair Solutions.*

*"The Difference is Engineering"*

**Leasing & Financing Alternatives Available**

## Dismantlers

### One-Man Dismantler



- 52" or 64" capacity
- 10 HP, 3-phase, electric motor standard (2200 FPM blade speed) (single phase available)
- Optional 15 HP, 3-phase (4400 FPM blade speed) electric motor available
- 18 HP gas-powered electric start on Portable Dismantler
- Gear reduction drive
- Self-contained hydraulic blade tensioning
- Low maintenance durable blade guide bearings
- Push button operated table height adjustment

### Two-Man Dismantler



### Pallet Dismantler System

- 64" capacity **Front Discharge** Dismantler
- Linear accumulating conveyor feeds boards easily to operator of Inclined Power Trim Saw
- Add additional dismantlers for higher production



### Portable Dismantler



## Notchers

### Double Head Notcher



- Two, 20 HP, three (3) phase, electric motors with V-belt driven indexable notching cutterheads
- One-person operation/1,000 double notched stringers per hour
- Notches new or recycled lumber
- 48" to 96" stringer capacity standard
- 9" x 1-1/2" notches, with 18" between notches
- Quick set-up
- Continuous power feed system
- Self exhaust design (useful when notching recycled material)

### Single Head Notcher

- 20 HP, three (3) phase, electric motors with V-belt driven indexable notching cutterhead
- One-man operation/500 double notched stringers per hour
- Notches new or recycled lumber
- 72" stringer capacity standard
- Quick set-up
- Continuous power feed system
- Self exhaust design (useful when notching recycled material)



## Pallet Prep



- Commonly referred to as the "SmartSaw"
- Smart Saw is **multifunctional**: designed for repair (1 person) or recycling (2 person) operations of BLOCK or GMA/STRINGER pallets
- Standard 10 HP, 3-phase, electric motor with gear reduction drive
- 20' standard **M42 bi-metal** band saw blade
- Air actuated, 3-position, roller table and table extension easily positions pallet for board removal
- Machine provided with **advanced safety measures** in place, including interlock switches for perimeter guarding and cabinet doors
- Improved **canopy guarding**, with front and rear portions that move up and down with the roller table

- Specifically designed to QUICKLY (as a **1-person** operation) cut out damaged boards, including **top and bottom** deck boards, as well as **connector** and **stringer** boards
- Also designed, as a **2-person** operation, to process the disassembly / tear-down of block or stringer pallets for **INCREASED LUMBER RECOVERY**. For block style machine, includes a specially designed **Block Recovery Tool** (or BRT) that **salvages blocks** now being scrapped with other machines and processes

### Double End Power Feed Trim Saw



## Trim Saws

- Power Feed Trim Saws trim boards 2" thick from 18" - 60" in length on the single end, and 18" - 66" in length on the double end
- Inclined board feed and overhead saw design help eliminate board kickback
- Manual Trim Saw handles boards up to 6" thick and 6" wide
- 18" diameter nail resistant saw blades and 10 HP motors
- Heavy duty steel tube construction
- Multiple adjustable board stops on Single End and on Manual Feed Trim Saws
- Easy blade change
- Easily moved with built-in fork lift pockets
- Right saw head on double end easily adjusts to cut desired board length

### Single End Power Feed Trim Saw



### Manual Feed Trim Saw



## SMART PRODUCTS

3401 North Commerce Drive • Muncie, IN 47303  
 Ph: 765.284.9545 • Fax: 765.284.7270  
 website: [www.smartproductsinc.com](http://www.smartproductsinc.com)  
 email: [smartpro@smartproductsinc.com](mailto:smartpro@smartproductsinc.com)

# 800.401.0099

Every machine we build is backed by the pallet industry's most trusted and respected reputation. You can count on us being here long after the others are gone.

# AccuraCut Deviation Detector



- AccuraCut Deviation Detector - \$7,500
- Controller/Display Unit
  - Sensor Unit w/ Universal Mount
  - 30 ft. of Sensor Cable
  - 5 Year Warranty (We believe in what we sell!)
- Extra Sensor Unit - \$650
- To Replace Original Sensor Supplied with System

*Push your equipment toward maximum production without destroying the sawblades—Blades are expensive and hard to get.*

"I've talked to many sawyers and, once they have one, they don't want to be without it." – Jeff Miller

Call or text to order yours.  
 Jeff Miller at (574) 370-5050  
 jeff5743705050@gmail.com

## EQUIPMENT FOR SALE

Salem Re-entry Tilt Hoist .... \$12,500.00



22" A-5B Nicholson Debarker, To be Rebuilt. PRICE: TBD

Kockum Cancar Resaw, Twin, 6 FT Horizontal Price: TBD



27" Dual Ring A5 Debarker, to be completely rebuilt. CALL NOW to customize for your needs!

### (5) Troughing Belt Conveyors

- (3) @ 24", 120' long
  - (2) @ 30", 120' long
- \$120.00 per foot**



**WCIS** LLC

Contact Jason Miller  
 541-451-6677

## Pallet Cutstock For Sale

### Mixed Hardwood and Green Pine

*Orders Needed for 28" to 48" Cuts*

#2 Pallet Lumber Available at Greatly Reduced Pricing!  
 (Heavy on 40" & 44" Lengths)

**Call Todd or Lisa: 931-296-1455**  
 trichardson@waverlywood.com

**Waverly Wood • Waverly, TN**

### WOOD WASTE GRINDING SOLUTIONS!

- Tub or Horizontal Grinders
  - Diesel or Electric
- Get ready for mulch season—make \$\$\$ from your waste!

800-743-3491  
 hogzilla@cwmill.com

See Us At:  
  
**EXPO**  
 Richmond  
 May 20-21  
 Booths 405-407

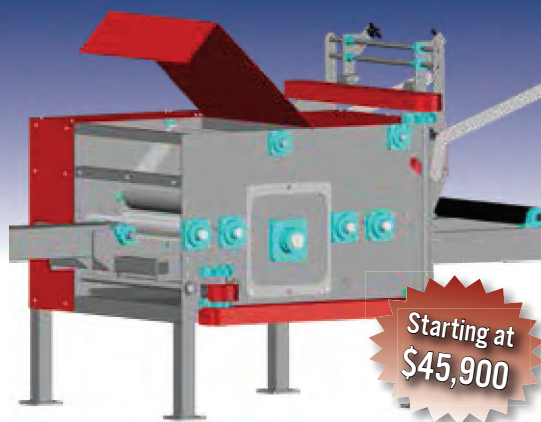

Starting at  
**\$45,900**



**Low Labor, Better Efficiency and Maximum Production—the ABM Way!**

**ABM AUTO SORTING SYSTEMS SAVE LABOR**

- AUTO SORT BY HEIGHT, WIDTH & LENGTH
- UNLIMITED NUMBER OF SORTING BAYS
- SIMPLE TOUCH SCREEN CONTROLS
- ACCOMMODATES ANY SIZE MATERIAL

**OUR JUNIOR SERIES EDGER IS NOW AVAILABLE**

- UP TO 4" CAPACITY
- CUSTOM MODELS TO FIT ALL PRODUCTION NEEDS
- SWING AWAY DOOR FOR EASY ACCESS TO BLADES
- SIMPLE DESIGN FOR TROUBLE-FREE OPERATION

**WHOLE TREE CUT-UP SYSTEM**

- FASTER, MORE EFFICIENT LOG PROCESSING
- 56" KODIAK BLADE (OTHER SIZES AVAILABLE)
- 30 HP HYD. SYSTEM
- OPERATOR CAB, 6 X 8 FT.

**Cut off Systems, Dedusters, Automatic Sorting System, Notchers, Edgers & Material Handling Equipment**



**417-204-5602**

1606 Sunset Terrace  
 West Plains, Missouri 65775  
 abmmachinery@usa.com



**Over 60 Years Experience!**

**Single Machines to a Complete Mill Design — We've Got You Covered.**

**Pallet Plates!**

Direct from the manufacturer.  
 Save \$\$\$ – Eliminate the middleman.  
**Fast, Reliable Service**  
 Pallet Repair/Recycling Made Easier!



**Engines, Power Units, Gen-Sets**  
 Remanufactured & USED  
**New Power Unit Radiators,**  
**Gauge Panels,**  
**& PTO Clutches In Stock.**  
**Specializing in**



**Leid Diesel Service**

**3 Locations to serve you:**  
 267 Green Hill RD. - Newville, PA 17241  
**717-776-7725**  
 N12574 Cty. Hwy. M - Thorp, WI 54771  
**715-669-3799**  
 2952 W. Carson City Rd. - Sheridan, MI 48884  
**616-754-5871**

See Us At:  
  
**EXPO**  
 Richmond  
 May 20-21  
 Booth 331

**Trusted National Leader**

**Biomass Boiler System Design, Fabrication & Installation**

**EFFICIENT SOLUTIONS for Lumber Drying, Industrial Heating, Energy Systems & MORE!**

**Wood Fired Industrial Shop Heaters**

**Automated Outdoor Wood Boilers**

**Material Handling**

**906-466-9010**  
 www.BurnChips.com  
 sales@burnchips.com

# The Right Fit with No Modification Required!

Our Replaceable Tip Hog Hammers and Lower Teeth  
fit ALL Montgomery Hogs...

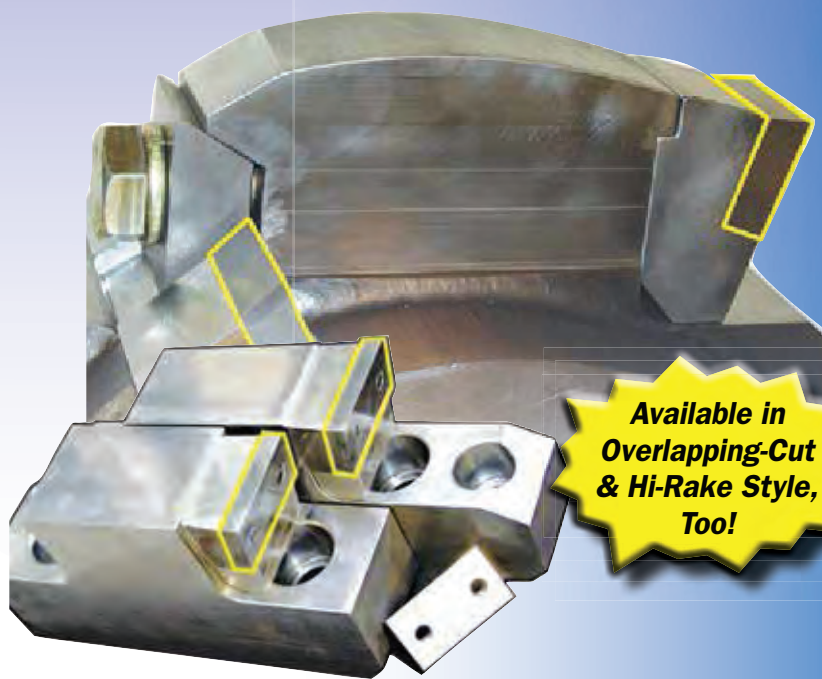

Available in  
Overlapping-Cut  
& Hi-Rake Style,  
Too!

- No more shipping parts back and forth to be rebuilt!
- No more waiting for parts to get back to you!
- No messy hardfacing welding and grinding of hammers!
- No more cracking/breaking off of hardfacing!
- You can... **"REBUILD" HAMMERS IN MINUTES!**



**1-888-244-0161**  
Fax: 503-293-0816  
www.ellisonsales.com  
sales@ellisonsales.com



Preferred Forestry Equipment Supplier Since 1956



Chippers

Log Cranes

Rosserhead Debarkers



Rotary Screens

Bark Hogs

Vibrating Conveyors

Parts & Services • Engineering • Project Management • Log Crane Inspections  
Equipment Design • Product Selection • Customer Service • Installation

## Fulghum Industries, Inc.

317 S. Main St., Wadley, GA. 30477  
Toll Free: (800) 841-5980 • Fax: (478) 252-1507  
www.fulghum.com • sales@fulghum.com  
Our service department is on call 24/7/365



FOLLOW US ON:

## 10 Dry Kilns For Sale



**Priced  
to move  
FAST!**



Jim: 706-590-3624 • Hunter: 706-590-4200  
abneyco@gmail.com • www.AbneyCo.com

## Precut Pallet Stock Hardwood & Aspen

Northern Hardwood KD Grade Lumber  
Call Philippe or Gilles V Martel **1-866-815-0404** (toll free)  
e-mail: gymartel@rlumber.ca  
pleblanc@rlumber.ca  
418-853-2225  
418-624-0038  
www.rlumber.ca



Lumber Resources delivers  
throughout North America

## Parts & Repairs For Your Nailing Machines...

Pallet, Wooden Box, Cable Reel & Tackless Nailers  
Specializing in FMC, Doig  
— even older Morgan & Gage machines!

**F.W. Morse / PVI Co. • 518-747-2017**  
www.nailingmachineparts.com  
e-mail: morgangageparts@gmail.com



# Low Profile Band Resaws — Designed & Built by the Morgan Family

Simple, compact design—Easy to operate and maintain  
Saves **BIG** on your labor costs!  
Returns cants “hands free” to the operator.

### Options Include:

- Electric (Single or 3-Phase), Gas and Line Shaft
- With or Without Returns
- Hydraulic Hold Down Wheels

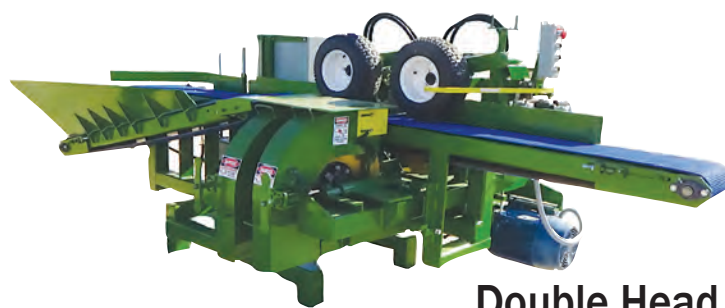

Double Head Resaw w/Return



Single Head Resaw w/Return



Four Head Resaw w/Return



Three Head Resaw w/Return



Line Shaft Single Head Resaw w/Return

**Sawmill Supplies & Equipment LLC**

Sarepta, LA

**318-994-2116**

e-mail: [sawmillsupplies@centurylink.net](mailto:sawmillsupplies@centurylink.net)

[www.sawmillsupplies.net](http://www.sawmillsupplies.net)



**Sales Office:**

Mona Tracy

**Universal Machinery Sales, Inc.**

**1-855-298-8890**

e-mail: [info@universalmachinerysales.net](mailto:info@universalmachinerysales.net)

[www.universalmachinerysales.net](http://www.universalmachinerysales.net)

*Building Genuine Morgan Equipment for over 30 Years.*

# Home of the Scragg

AND EDGERS, GANGS, MERCHANDISING, SORTING AND SLAB RECOVERY SYSTEMS AND MORE!



LET US SHOW YOU HOW TO MAKE MORE PALLET CANTS AND RECOVER SLABS!

COME SEE US AT EXPO RICHMOND!  
BOOTH #640



ASK US HOW AT 478-252-5885 FOR MORE INFORMATION  
EMAIL: [INFO@COOPERMACHINE.COM](mailto:INFO@COOPERMACHINE.COM) WEBSITE: [WWW.COOPERMACHINE.COM](http://WWW.COOPERMACHINE.COM)

# Metal Detectors, Inc.

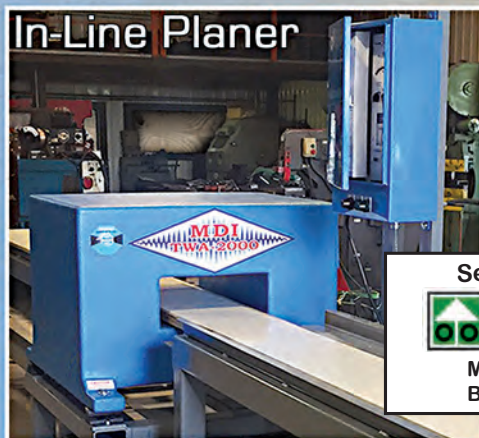

See Us At:  
 EXPO  
Richmond  
May 20-21  
Booth 233



*Our track record speaks for itself!*



MP-2000

XR-3000

P: 541.345.7454 - F: 541.345.7971 - [sales@mdiblue.com](mailto:sales@mdiblue.com) - [www.mdiblue.com](http://www.mdiblue.com) - Eugene, OR USA

**USED & REFURBISHED EQUIPMENT AVAILABLE...**  
**CHECK OUT OUR INVENTORY FOR CAN'T MISS BARGAINS!**



**Montgomery 18HD40-HZF 75hp  
 Horiz-Feed Hog Pkg 10581**



**Montgomery 20LRW Low-Speed  
 25hp Grinder 10585**



**Jeffrey 34WB Hog  
 100hp 10445**



**Legacy 27x23.5  
 Hammer Hog 10522**



**Montgomery 34HD50  
 10328**



**Vecoplan Horiz-Feed  
 Grinder 10562**



**Jeffrey 45WB  
 Rebuilt Hammers 10568**



**Lamb 100hp  
 Hog Pkg 10526**



**Montgomery 75CSKC  
 Hog 10584**



**Montgomery Model  
 27CSKC Hog 10127**



**Montgomery 33CSKC  
 Hog 10573**



**Montgomery 34RC60  
 BloHog 10563**



**Montgomery 57PMKC  
 Hog 10504**



**West Salem 3456BH  
 Horiz-Feed Hog 10173**



**Montgomery 50HDER  
 Hog 10572**



**31-foot Hopper  
 Conveyor 10582**

**Already have a Montgomery Hog?  
 We supply all the parts you'll need!**



**ELLISON SALES, INC.**

**Toll-Free: 888-244-0161**

E-mail: [dan@ellisonsales.com](mailto:dan@ellisonsales.com) • [www.ellisonsales.com](http://www.ellisonsales.com)

**Portland,  
 Oregon**

# MenomineeSaw.com

Your Sawmill Supplies Online

## Super Store

### WIDE & THIN KERF BLADES



Sawmill Band Blades  
Wood-Mizer Sawmill  
13'1" x 1-1/4" x .042 7/8 TS



Resaw Band Blades  
Brewer Resaws  
16'6" x 1-1/4" x .042 7/8 TS



Resaw Band Blades  
Go Fast Resaws  
15'1" x 1" x .035 3/4 TS

### TALLEY & GRADING SUPPLIES



Dixon Lumber Crayons  
Choice of Color  
4 1/2" x 1/2"



Four Line Lumber  
Grading Ruler  
39" x 1" with GoNoGo Head

4 Page Leather  
Tally Book  
Holds Standard  
4" x 8" Tally Sheets



### SAW BITS & SHANKS



Simonds Si-Chrome  
Saw Bits  
B&F 8-9 9/32 Long



Simonds Super Shanks  
F Style FX9 Double  
Circle Design



Simonds Dominator  
Carbide Bits  
B&F 8-9 9/32

### EVERYTHING ELSE YOU NEED TOO!



Simonds Chipper Knives  
58" Precision or Morbark  
19-5/8" x 4" x 3/8" Babbitt  
or Set Screw



Logrite Aluminum  
Cant Hook  
30" - 60" Non-Slip Handle



Laser with Mounting  
Bracket  
Red Diode 120VAC  
or 12VDC

FOR FAST SHIPPING & GREAT PRICES ON EVERYTHING YOU NEED TO KEEP YOUR MILL RUNNING - VISIT

# MenomineeSaw.com

Adding  
Items  
Daily!



See Us At:  
**EXPO**  
Richmond  
May 20-21 • Booth 712

**1-800-582-0470**

906-863-2609 • Fax: 906-863-1147  
Email: info@menomineesaw.com

Subscribe to  
Receive Exclusive  
Discount Offers

## Own a Sawmill?

DAVIDTODDLOGGING@GMAIL.COM  
Call, write, or email John to receive our free equipment catalog

March Issue  
Compiled by SE SHOWCASE EQUIPMENT LLC

Financing Available!

See Inside for full lineup of equipment!

Want to buy?  
Wayne Miller (Sales): 260-585-2388  
Email: sales@showcaseequipment.us

John Yoder (General Manager): 260-214-3481  
Email: john@showcaseequipment.us

Want to advertise or list your equipment?  
Darin Bontrager (Advertising): 574-536-1646  
Email: darin@showcaseequipment.us

- Band Mills
- Circle Mills
- Band Resaws
- Edgers
- Debarkers
- Chippers/ Grinders
- Transfer decks/ Conveyors
- Blowers
- Power units
- Loaders/ Forklifts

**John Yoder (Sales):**  
260-250-3713  
Email: jy@showcaseequipment.us

New Address:  
206 Vine St  
Wolcottville IN 46795

### 1.5" Radius Notcher

### Our Indexable Cutters

- 5" Radius Notcher
- Cant Sizer/Planer
- Sidehead/Hogger

See Us At:

May 20-21  
Booth 612

Simply **STRONGER.**  
Simply **SMARTER.**

Here's why Econotool cutting heads are simply the best choice:

- Every cutter is interchangeable and bolted one to the next.
- Our notchers feature removable, hardened end cutter nests (Econotool exclusive) that are bolted to the body.
- Split cutters, short keyway or combination mounting options mean exceptional balance and less vibration.
- Our cutters feature indexable 4-sided carbide inserts with radiused corners to provide more cutting life between changing.

See why we are the smartest choice for Indexable insert cutters for Notching, Cant Sizing & Sidehead/Hogging, Chamfering, Rotary/Disc Pallet Disassembly blades & Saw blades. We also make carbide inserts for cutting wood or wood with nails.

**For the lowest pricing and availability,  
Call toll-free, 1-800-245-9663**

Precision Designed with Your Economy in Mind.

QUALITY  
SINCE 1947

2971 FRANKS ROAD • HUNTINGDON VALLEY, PA 19006  
PHONE 215-947-2404 • FAX 215-947-0529  
WWW.ECONOTOOL.COM

# MADE IN AMERICA

The ORIGINAL reclaimed lumber nailing machine.

Redesigned, one-of-a-kind pallet flipper.

Up to 400+ pallets per shift.

Only 1 operator required.

Built to perform and last.

Built in Iowa, from the ground up.



[www.woodpeckermachine.com](http://www.woodpeckermachine.com)

(888) 577-3886

See Us At:  
**EXPO**  
Richmond  
May 20-21  
Booth 740

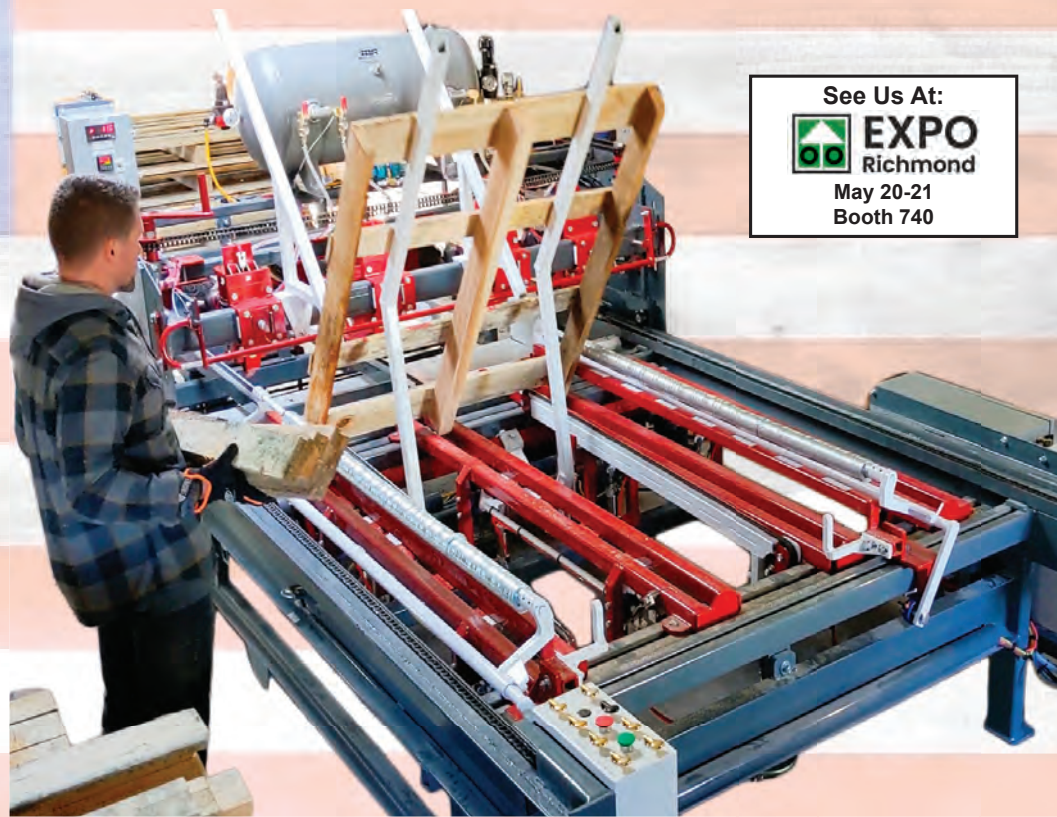

Sales, support, and service by:



Visit us at EXPO Richmond  
May 20-21, 2022  
in the Old Dominion Building



- Meet our expert machinery sales staff
- See the latest, most innovative equipment
- Watch live demonstrations

**PMG** (540) 644-9220  
[www.PalletMachinery.com](http://www.PalletMachinery.com)

**Stock Your Sawmill  
With The Best Saws**  
— Since 1890!

See our web specials at:  
[www.paynesaws.com](http://www.paynesaws.com)  
**800-752-0627**

## CUSTOM MATERIAL HANDLING & AUTOMATION *Fast Lead Times and Custom Options*



- ✓ CONVEYORS: Belt, Chain, Roller & Powered Infeed/Outfeed.
- ✓ ALSO: Chain Decks, Tilt Hoists, Unscramblers, Box Dumps, Recycling/ Picking Lines, Turntables, Stacking Boxes, & Carts. Guaranteed Highest Standards
- ✓ All Custom Fabricated Material Handling Items Considered

*Many PLC Controls Options Available*

**Trade Ins Considered - Call Today**

**205-620-4455**

[bit.ly/SmithMachineWorx](http://bit.ly/SmithMachineWorx)



Connor Smith 205-601-0044  
[csmith@smithcos.com](mailto:csmith@smithcos.com)

Phil Smith 205-910-7777  
[psmith@smithcos.com](mailto:psmith@smithcos.com)



# Sawmill, Pallet, & Logging Equipment Auctions & Liquidations

260.250.4597 [www.BrightStarAuctions.com](http://www.BrightStarAuctions.com)

**UPCOMING AUCTIONS**

Ask About Our **RISK FREE** Options!

100+ Years of Combined Sawmill & Auction Experience Working For You!

**Arnett's Landscaping**  
Constantine, MI •  
May 7th

*Landscaping Equipment Liquidation*



**Annual Appalachian Auction**  
Elkin, NC •  
May 12th

*Equipment Consignment Auction*



**Formerly Shingleton's Sawmill**  
Augusta, WV •  
May 18th

*Real Estate and Sawmill Equipment Auction*



**Bowser Lumber Co.**  
Mahaffey, PA •  
May 19th

*Sawmill and Logging*



**Bright Star May Virtual Auction**  
Online & Phone Bid Only •  
May 20th & 21st

*Equipment Consignment*



**Buckeye Mouldings Auction**  
(lots 2100-2190 in the May Virtual Auction)

**May 20th & 21st**

*Quality Woodworking Equipment*



**Foster's Logging**

(lots 2202 & 2300-2316 in the May Virtual Auction)

**May 20th & 21st**

*Sawmill Operation*



**10 Portable Bandmills**

Online & Phone Bid Only •

**May 20th & 21st**



## You Can Hire Integrity... But It Can't Be Bought

Bright Star holds proper licenses in each state as required. License numbers available upon request.

Ask About Our  
**RISK FREE**  
Options!



**UPCOMING  
AUCTIONS**



**100+ Years of Combined Sawmill & Auction Experience Working For You!**

**Bright Star June Virtual Auction**  
Online & Phone Bid Only •  
**June 17th & 18th**  
*Equipment Consignment*

**Bright Star Equipment Consignment Auction**  
Middlebury, IN •  
**July 1st**  
*Taking Consignments*

Previous  
Items  
Featured



**Sold for \$100,000!**



**Sold for \$42,500!**



**Sold for \$99,000!**

**Kiser Lumber**  
Bowman, SC •  
**June 16th**  
*Sawmill Equipment Auction*



**Zimmerman Sawmill**  
Denver, PA •  
**July 7th**  
*Sawmill & Rolling Stock*

**Williamsfield Valley Veneer**  
Williamsfield, OH •  
**September 15th**  
*Sawmill Equipment Auction*



**Showcase Equipment Auction & Expo.**  
Wolcottville, IN •  
**September 23rd**  
*Equipment Consignment Auction*

**Polley Lane Sawmill**  
Gillman, WI •  
**For sale as an entirety**  
*Real Estate and Business*



**Countryside Buildings LLC**  
Summersville, MO •  
**For sale as an entirety**  
*Turn Key Mini Barn Business includes  
Real Estate*



**You Can Hire Integrity... But It Can't Be Bought**

Bright Star holds proper licenses in each state as required. License numbers available upon request.

800-362-9332 **McGREGOR** PACKAGING www.mcpackage.com

Henry says...  
**If you saw it,  
strap it with  
McGregor!**

**TRY PLASTIC!**

**\$275**

**No Risk Trial Kit**  
(Money Back Guarantee)

P.O. Box 7552, Tifton, Ga 31793 • 108 E. Ogeechee Street, Sylvania, Ga 30467 • P.O. Box 277, Ailey, Ga 30410

## FOR SALE

Pendu Stacker Take Away  
(Several Available)

Lumber Transfer Deck,  
19' long 2-strand  
C55B rooftop chain #1495

10' long, 5" wide driven Roll-case  
w/ 2 driven top pinch rolls,  
air actuated #1496

Lumber Transfer Deck,  
26' long 2-strand  
C55B rooftop chain #1498

Pendu Model 3800 Stake Pointer #1568

For complete details call  
**800-233-0471**  
Email: info@pendu.com  
**www.pendu.com**



**NEW PRECISION  
7X7 SCREEN**

**Ben Jones Machinery**  
Div. of Dickert Enterprises, Inc.  
Industry's Most Trusted Source  
**800-241-8983**  
See more equipment at  
**www.benjones.com**



**RAWLINGS** **WOOD HOGS**

For over 40 years Rawlings has offered a complete line-up of the most productive and cost efficient wood grinders available

**WASTEWOODHOGS.COM 1-866-ROCWEAR (762-9327) SALES - PARTS - SERVICE**



**FW-16 Firewood Wrapper**  
 Better firewood bundles for less. Go Fast Wrappers are heavier duty by design. Built with true gear reduction and heavy duty frames a Go Fast Wrapper will outlast the competition. Simple, safe, and reliable.

**Standard features:**  
 1/3 HP 120V Motor  
 Fork Pockets  
 HD Gear Box



**GOFAST** MANUFACTURING  
 1-800-854-7439  
 WWW.GOFASTMFG.COM

**CUTSTOCK FOR SALE**  
**931-308-7245**  
**931-469-5558**

**FIVESTAR**  
 LOG PLATES

**Ready to Ship!**

These plates are designed to protect logs from splitting as they dry between harvest and the mill.

**CALL US TODAY!**



PRR Group Inc. • 2 Eastgate Drive • Jacksonville, IL 62650  
 PHONE: 217.291.0009 FAX: 217.291.0008  
 TOLL FREE: 866-546-8864 www.prrgroupinc.com

**STAKE POINTERS FOR SALE**  
 Keystone Machinery Corp.  
 Ephrata, Pennsylvania  
**717-859-4977**

**WE REBUILD MONTGOMERY HOG ROTOR ASSEMBLIES**



**ELLISON SALES, INC.**  
 Toll-Free: 888-244-0161  
 dan@ellisonsales.com

DRYING CHAMBERS & COMPONENTS  
**KILN DIRECT**

WWW.KILN-DIRECT.COM  
 SALES@KILN-DIRECT.COM  
**910 259-1624**



**PALLET KILNS**  
**280-800**  
 PALLETS CAPACITY

PORTABLE TURN KEY UNITS WITH FAST TREATING TIME  
 HEAT TREATS AND DRIES IN THE SAME CHAMBER  
 COMPUTERIZED RECORD KEEPING  
 HIGH EFFICIENCY DIRECT GAS HEATING  
 ALUMINUM OR STAINLESS STEEL CHAMBER  
 END-LOAD MODELS 300-800 PALLET CAPACITY  
 SIDE-LOAD MODELS 280-700 PALLET CAPACITY  
 PIGGY-BACK SYSTEM FOR INSULATED VAN BODY / CONTAINER

**FIREWOOD KILNS**  
**750-3500**  
 ANNUAL CORDS CAPACITY

WOOD WASTE OR GAS HEAT  
 EASILY MEETS 160F FOR 75 MINUTES  
 HEAT TREAT IN 8-16 HOURS  
 KILN DRIES GREEN FIREWOOD IN 1-2 DAYS  
 BASKETS FOR OPTIMIZED AIRFLOW ARE AVAILABLE  
 FIREWOOD KILNS THAT HAVE BEEN SPECIFICALLY DESIGNED TO DRY AND HT FIREWOOD QUICKLY AND EFFICIENTLY

**LUMBER KILNS**  
**9-21**  
 MBF CAPACITY

100% ALUMINUM CONSTRUCTION  
 GAS, HOT WATER OR STEAM HEATED  
 POWER VENTING WITH HEAT RECOVERY  
 BI-FOLD DOOR WITH ELECTRICAL OPERATION AS AN OPTIONAL UPGRADE  
 COMPUTERIZED CONTROLS  
 WITH WIRELESS COMMUNICATION TO OFFICE



**2-3 HOISTS**

**CUT STOCK MULTI-HOIST DIP TANK**

**LUMBER DIP TANK WITH TILT**

**SAVES CHEMICALS**

**EAGLE DIP TANKS**

**910 259-9794**  
 WWW.EAGLEDIPTANKS.COM  
 SALES@EAGLEDIPTANKS.COM

**Attention Southeast Pallet Operations -**  
 We offer Pallet Cut Stock delivered to your plant. Reasonable prices - Reliable delivery!

**We also supply:**

- Crating products
- Particle Board, MDF
- Packaging products
- Hardwood Lumber
- Treated Materials
- Import-Export wood products
- SYP Plywood, OSB
- SYP Lumber



**Call 800-366-6374 or 601-878-2581**  
 sales@magnoliaforest.com

**DYNAHOG**  
HIGH PERFORMANCE GRINDER PARTS

Screens, Hammers, & Other Parts for **SWING HAMMER** Tub & Horizontal Grinder Applications for Jones, WHO, Haybuster, & Other Brands.



Numerous Weld Patterns Available for Your Hammers!

**GRINDER SERVICE & REPAIR**

**WE BUILD CUSTOM SCREENS!**

Call for a Quote!

Email: sales@dynahog.com  
**800.743.3491**  
**DYNAHOG.COM**

**ARMORHOG**  
Extreme Duty Grinder Parts

**RIGID HAMMER STYLE** Tub or Horizontal Screens, Tips, Belts, & Other Parts.

**CUSTOM SCREENS!**



Call for a Quote!

Ask About **NITROGRIT™ Carbide!**

Grinder Repair & Service, Rotor Repair or Replacement & Electronic Balancing Available for ALL BRANDS & Models of Grinders Including Bandit, CBI, Diamond Z, Morbark, Peterson, Vermeer...

Email: sales@armorhog.com  
**800.743.3491**  
**armorhog.com**

**Moisture Meters**  
**Pin and Pinless**



**Buy Quality, Reliability and a 2-Year Warranty at Lignomat's affordable Prices.**

**For best price call with promo code ALP**

**www.lignomat.com** 503-257-8957 Portland, OR  
**800-227-2105** or Email: sales@lignomat.com

**HOGZILLA®**

**DIESEL OR ELECTRIC - TUB OR HORIZONTAL THE ONE & ONLY GRINDER WITH MONSTER PRODUCTION!**

CW has been manufacturing top quality electric and diesel powered grinders for over 45 years. We know our customers businesses depend on a reliable machine with increased efficiency, reduced maintenance, heavy duty construction, and simplicity. Our customer service speaks for itself and our customers can attest to that.

**ITS SIMPLE...**  
We Will Build Your HOGZILLA MONSTER GRINDER How You Want It.



HogZilla Model TCII-1564P  
Our Most Popular Diesel Powered MONSTER!

CW MILL EQUIPMENT CO., INC., Sabetha, KS, U.S.A.  
800-743-3491 • Email: hogzilla@cwmill.com

**HOGZILLA.com**   

**Need Blades Now?**  
**Orders Ship in 1-2 Days!**



**We produce blades for any sawmill or resaw! Call Today!**

**Call or email for your FREE Catalog!**

**WE HAVE BLADES FOR SAWING GREEN WOOD, HARD WOOD, PALLET STOCK AND MORE!**

**ORDERING MADE EASY:**  
↳ ORDER ONLINE AT [WWW.COOKSSAW.COM](http://WWW.COOKSSAW.COM)  
↳ OR CALL 1-800-473-4804  
↳ TELL US HOW MANY BLADES YOU NEED  
↳ DONE!

**COOK'S SUPER SHARP™**  
*Nobody makes a tougher blade!*

**COOK'S SAW MFG., LLC**  
LEADERS IN BANDSAW TECHNOLOGY  
PHONE: 1-800-473-4804 [WWW.COOKSSAW.COM](http://WWW.COOKSSAW.COM)

WWW.FRONTLINEEQUIPMENT.NET  
**FRONTLINE EQUIPMENT, LLC**  
 Out Front Where Things Happen

**LET US MOVE YOUR DUST!**

*Need a blower?  
 We have a great selection of sizes available. Choose from 18", 26", 26"CB and 42".*



**FRONTLINE STANDARD DUTY EDGER**  
 MODEL 430SD / MODEL 436SD



*Thank you*

to everyone who helped make 2021 a successful year. We are looking forward to serving the industry throughout 2022!



**Lumber Carts made to order!**  
 Extendable available.



Log Turner



Waste Conveyor

*Call for your sawmill equipment needs, we can custom build what you need!*

9267 Front Mountain Road  
 Allensville, PA 17002

**717-483-6556**

Fax 717-483-6051

Email [parts@frontlineequip.com](mailto:parts@frontlineequip.com)

**Touchscreen computer networks now available on Edgers!**



**LET US CUSTOM-BUILD A GREEN SCREEN FOR YOUR MONTGOMERY HOG  
OR PICK BLUE FOR YOUR NEXT JEFFREY HOG SCREEN GRATE!**



**FOR FAST, RELIABLE SERVICE, CALL THE EXPERTS WITH 45 YEARS EXPERIENCE!**

**ELLISON SALES, INC. • TOLL FREE: 1-888-244-0161**

**FAX: 503-293-0816 • EMAIL: sales@ellisonsales.com • www.ellisonsales.com**

## One Stop - Full Service

North America's LARGEST Sawmill, Pallet & Wood Industry Used Equipment Dealer

**We Provide Options, Letting You Select What is Best For You!**

### Appraisals

Our High Volume Sales, Combined with Knowledge and Experience Provides

**Accurate, Real World Pricing**

### Entirety Sales

Direct Marketing, Direct Purchasing and Owner Participation Agreements

**Comprehensive Flexible Options**

### Full Plant Liquidation

Free Up Your Assets, Settle Estates or Sell Unused Equipment or Operations

**Use Our Network To Get It Sold**

**Appraisal • Liquidation • Auction • Entirety • Commission**



731-986-4351 | sales@lps-inc.com



Schedule a No Obligation Consultation!

**731-986-4351**

LPS-Inc.com

**Need Parts to Fit Your Morgan Saws?**



Sawmill Supplies & Equipment, LLC  
supplies, parts and more!

Office: **318-994-2116**  
www.sawmillsupplies.net  
E-mail: sawmillsupplies@centurylink.net  
Still Building the ORIGINAL Low Profile Single Resaw



**NEW PRECISION 58" CHIPPER**  
Ben Jones Machinery  
Div. of Dickert Enterprises, Inc.  
Industry's Most Trusted Source  
**800-241-8983**  
See more equipment at  
www.benjones.com



Complete Scragg System w/Tipton Iron Works Trimsaws, Horiz Saw, Linebar, Edger along w/ Cut Up System, Conveyors & More!  
Scott 304-478-2500 ext.111

**WANTED**  
AIR CURTAIN BURNER  
FIRE BOX, ANY MODEL  
617-592-5799



**PUTTING THE COMPETITIVE EDGE IN YOUR HANDS.**

Every operation needs an edge. And you'll get one with Simonds **PreSharp™** blades. Backed by the industry's best service, you'll experience superior blade performance with our unique square-faced edge for faster feed rates and a smooth, clean cut.

**Invest in your operation, and gain the competitive edge. Choose the blades that outperform the rest.**



Simonds **PreSharp™** blades have a unique, square-faced cutting edge that:

- Delivers cleaner boards.
- Increases production.
- Puts more \$\$\$ in your pocket.



Digital Tension Gauge for Bandsaw Blades

Know your machine's optimum number and hit it!

Conventional blades channel dust to the side of the blade, increasing dust spillage.

**CALL FOR THE DEALER NEAREST YOU 1-800-426-6226**  
simondsinternational.com | Fitchburg, Mass. USA



**HUGE INVENTORY- FORKS**



Available for quick shipment call for pricing!

THICK	WIDE	LONG	HIGH
2"	5"	48"	48"
2"	5"	60"	48"
2"	6"	48"	48"
2.5"	6"	48"	48"
2.5"	6"	60"	48"
2.5"	6"	72"	48"
3"	7"	60"	48"
3"	7"	72"	48"
3"	7"	96"	48"
3.5"	8"	96"	60"
3.5"	8"	108"	60"

Ask about our Grapples!

We offer forks, rakes, buckets, thumbs, grapples, and much more!

Nationwide Toll Free  
Ohio: (800) 803-3365  
www.aimattachments.com

**2 CHOICES for MORE FIREWOOD PRODUCTION!**

NEW Model 18-20 Hornet Firewood Processor

18" Diameter, 24" Stroke

- Sell Bundled Firewood to Convenience Stores, Campgrounds, and State Parks
- Seven Bundle Sizes Available: Electric or Gas
- Wrap a Cord of Bundles Per Hour
- Wrapper Priced Under \$1,700

www.twister-industries.com  
accounts@twisterequipment.com

**Twister Industries**  
Phone: (320) 679-9835  
Cell: (612) 390-9620  
2266 Hwy. 65 • Mora, MN 55051

**Twister Hornet Model 2530 Firewood Processor**

Hornet Processors, Bundle Wrappers, Re-splitters, Skid Steer splitters, Wood Splitters, Conveyors

2-4 Strand Live Deck, Tandem Axles, 45 Gal. Fuel & Oil Cap.



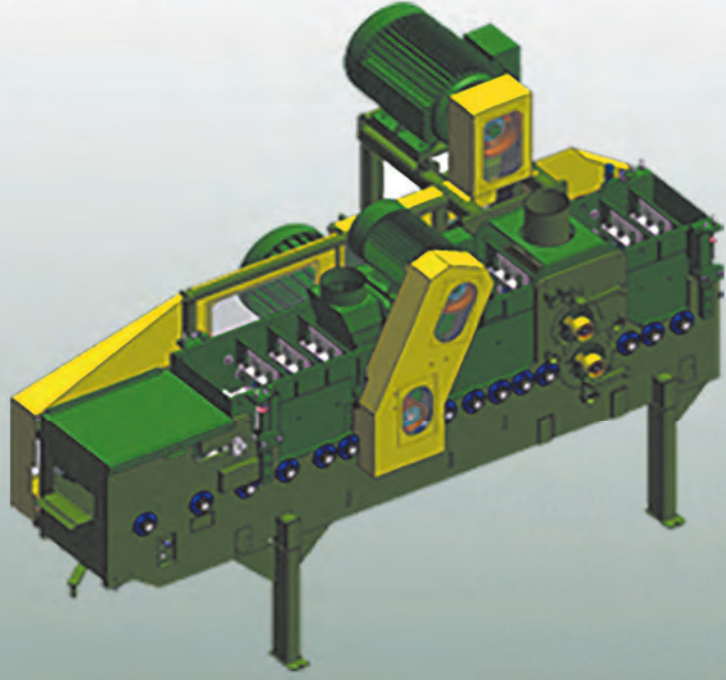

## HEAVY DUTY GANG SAWS



Pallet Machinery

Custom Ma

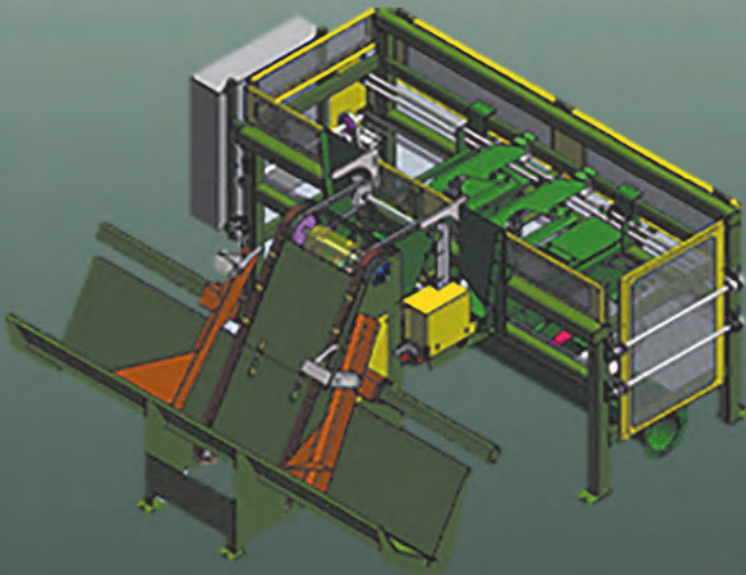
## HIGH-SPEED NOTCHERS



## MULTIPLE SAW TRIMMERS

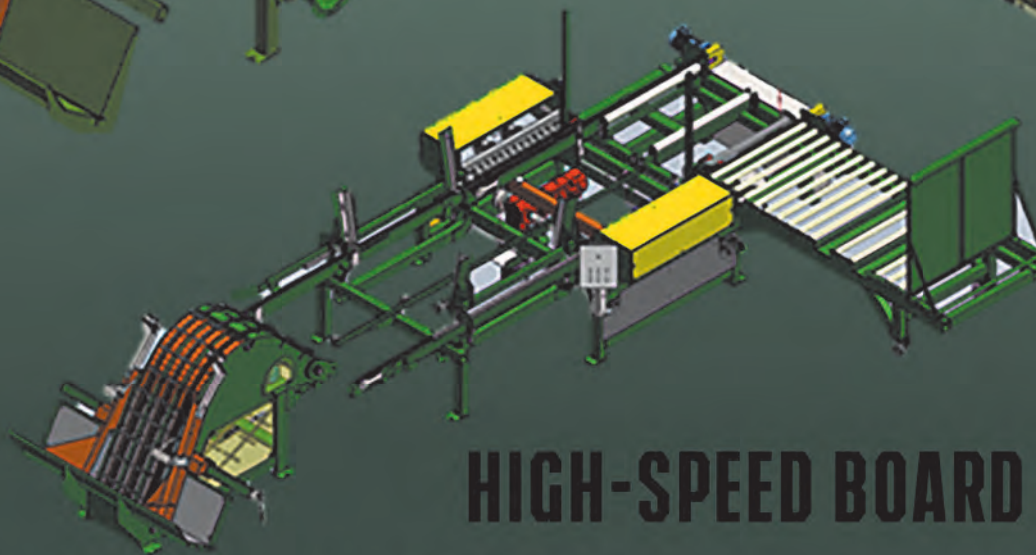
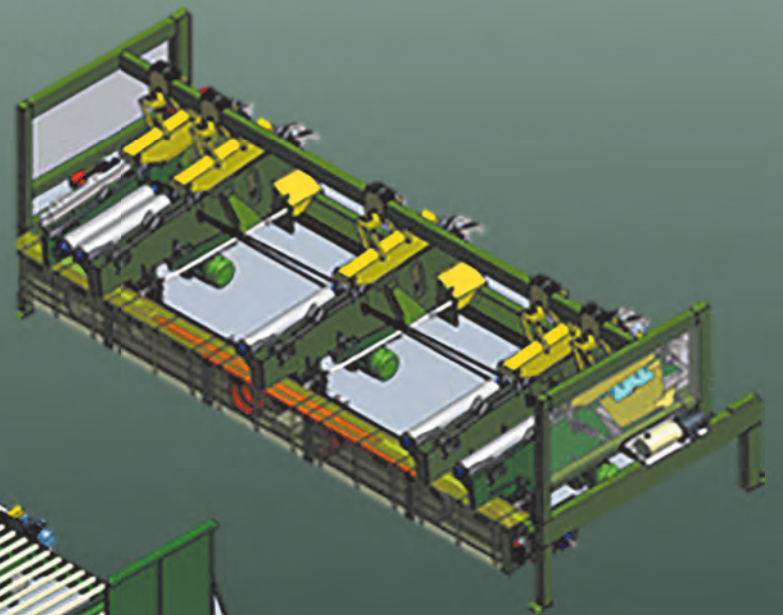

## HIGH-SPEED BOARD STACKERS

717.354.4348

800.233



## HEAVY DUTY EDGERS

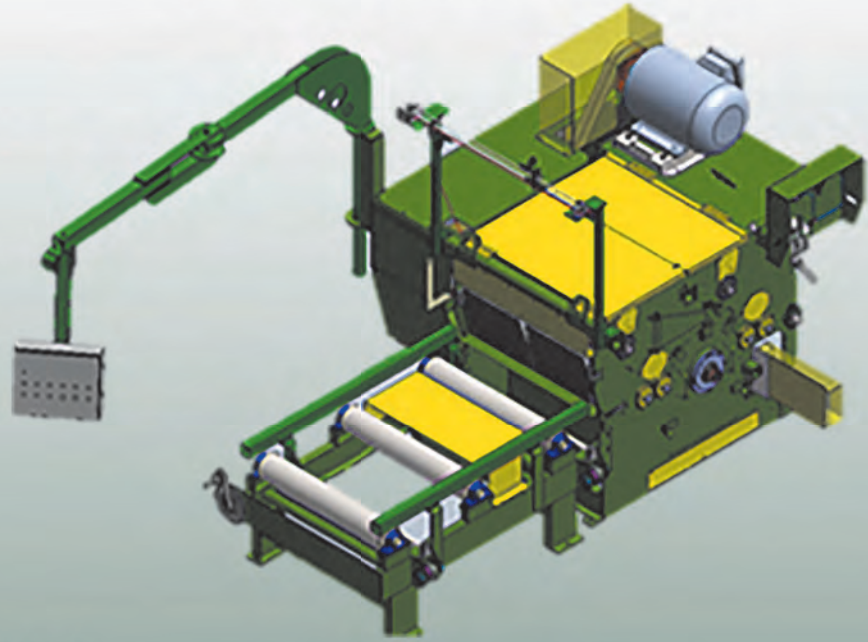

achinery

Sawmill Machinery

## HIGH-SPEED TWO SAW TRIMMERS

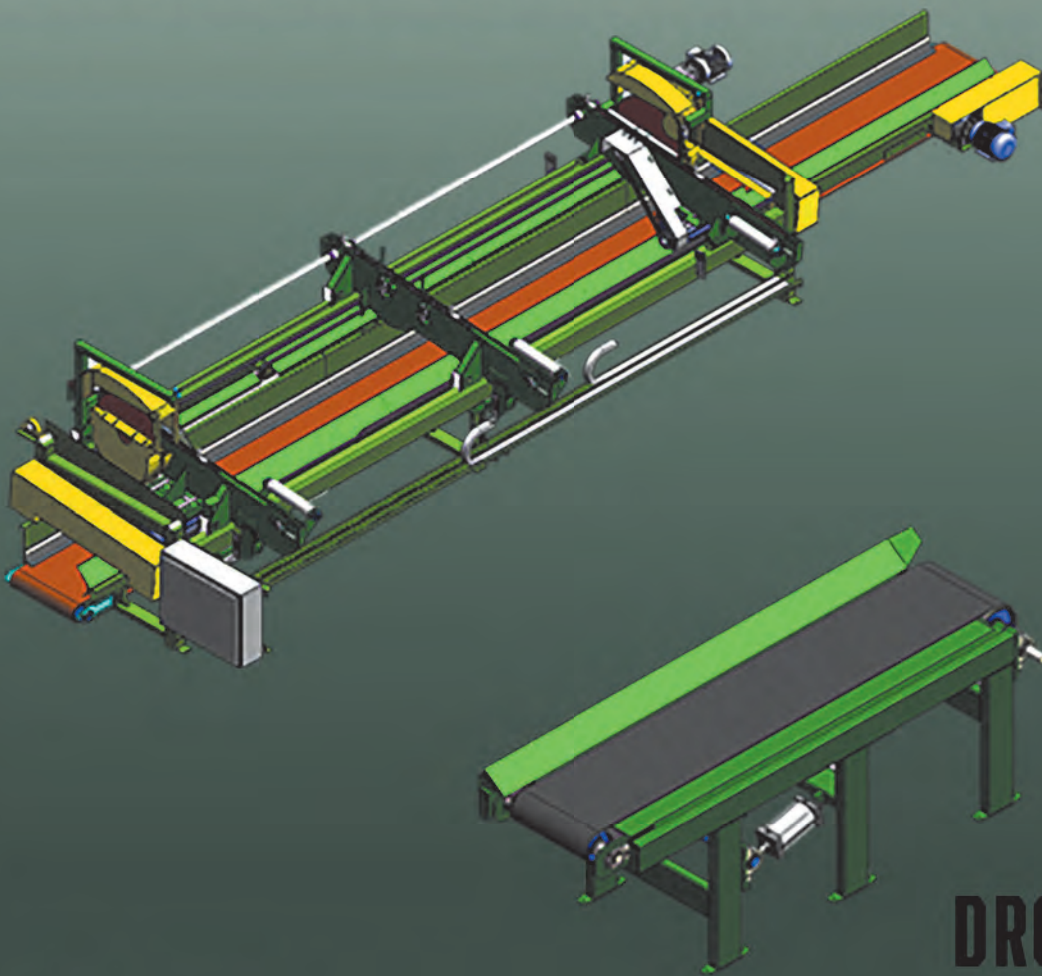

## DROP SAW TRIMMERS

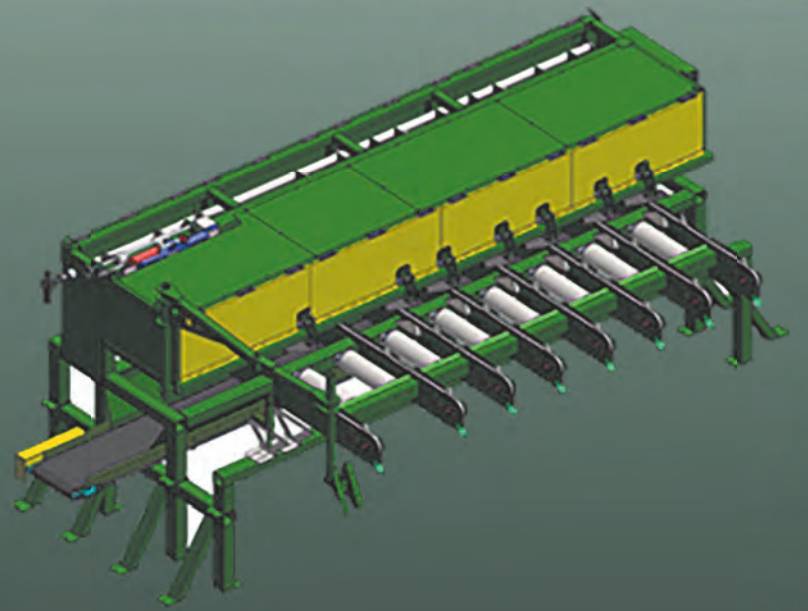

## DROP BELT CONVEYOR

8.0471

[www.Pendul.com](http://www.Pendul.com)

# Your "Go-To" Source for Sawmill Supplies...

## Wide Bandsaws \* Shanks \* Sawbits

**Bartlett's Saw has supplied sawmills with better parts, supplies & service since 1978! Rely on us to keep your mill running right.**



Need Wide Bandsaws, 4-8" wide, in single and double cut, 1 3/4" to 2" tooth space.  
**Guaranteed to run... right out of the box!**



Our Shanks are so good, they're guaranteed!  
**If they split or crack, we'll replace them for FREE!**

Check out our Sawbits...  
**The Eurobits & Econobits**



Call us to place your next order...  
**800-566-0319**



621 US 41A • Henderson, KY 42420



Every product we manufacture and sell must meet our high standards before being shipped.

**Guaranteed Products**  
**+ Quick Delivery**  
**+ Proven Experience**  
**= Your Success**

**We also supply Edger Saws, Slasher Saw Bits, Saw Grinders & Lots More!**

## Used Machinery

**Call Mona Tracy Today**

- 1- Voltage Transformer Step Down
- 1- Bob Cat #743
- 2- Pallet Chief IIIs
- 1- Complete Cutting Pallet Sawmill
- 1- Willow Creek Notcher
- 1- Morgan 2 Blade Multi Trim Honda (24)
- 1- Wood-Power Grinder
- 1- Prona Cut Off Saw
- 1- Bio Mass Furnace
- 1- In Line Nailer 64" x 84"
- 1- Miner Edger - Live Shaft
- 1- 2 Blade Multi-Hd Honda - Hydraulic
- 1- Tipton Scragg
- 1- Senco Pop Up Saw, 18"
- 1- Phase Converter
- 1- Yale Forklift, 6000#
- 1- Morgan Resaw, Diesel or Gas
- 1- Morgan Resaw Line Shaft-Single
- 1- 262 Blower
- 1- 3-Head Brewer Resaw
- 1- Nail Mate Nailer
- 3- Lead Board Removers
- 1- Solo Pallet Dismantler
- 1- Pendu Horizontal Splitter Saw
- 1- Stacking Rack Work Table
- 1- 8' Round Table
- 2- Chamfers: Newman & Brewer

**List your used equipment with us!**

**UNIVERSAL**  
MACHINERY SALES, INC.  
Toll Free **1-855-298-8890**  
or **812-298-8090**  
sales.universalmachinerysales@gmail.com

## THINKING AUCTION?

Call: **800-432-1922**  
**WAUSAU AUCTIONEERS**  
SALES CORP. P.O. BOX 1311 • WAUSAU, WI • 54403-1311  
PH: (715) 536-1955 • (800) 432-1922  
**"Forest Products Specialists"**



PRECISE, TARGETED ADS THAT CAN BE DISPLAYED ON:



REACH MORE CUSTOMERS. ANYTIME, ANYWHERE.

CALL OR EMAIL TODAY TO FIND YOUR SOLUTION!

BRIAN CRUZEN  
P: 901-767-9126  
E: BRIAN@HMR.COM



## The Leader In New Chain Bars & Repairs Since 1961

**: Celebrating 60 Years :**

Cut off bars for bundled lumber and cut off applications  
*We repair all types of bars and offer custom manufactured bars for all aspects of the forest industry.*



See Us At:  
**EXPO**  
Richmond  
May 20-21 • Booth 420

CALL TODAY **360-687-2667**



22703 NE 216TH AVE  
BATTLE GROUND, WA 98604  
360-687-2667 MAIN 360-687-2917 FAX  
WWW.SERINGSAWMILLMACHINERY.COM  
SALES@SERINGSAWMILLMACHINERY.COM

ALSO DISTRIBUTORS OF CARLTON SAW CHAIN & RAPCO INDUSTRIES CARBIDE TIPPED SAW CHAIN



# ***Looking for a Pallet Assembly Machine But Don't Want to Wait Forever?***

***The Timberwolf offers shorter lead times as compared to other machines available today.***

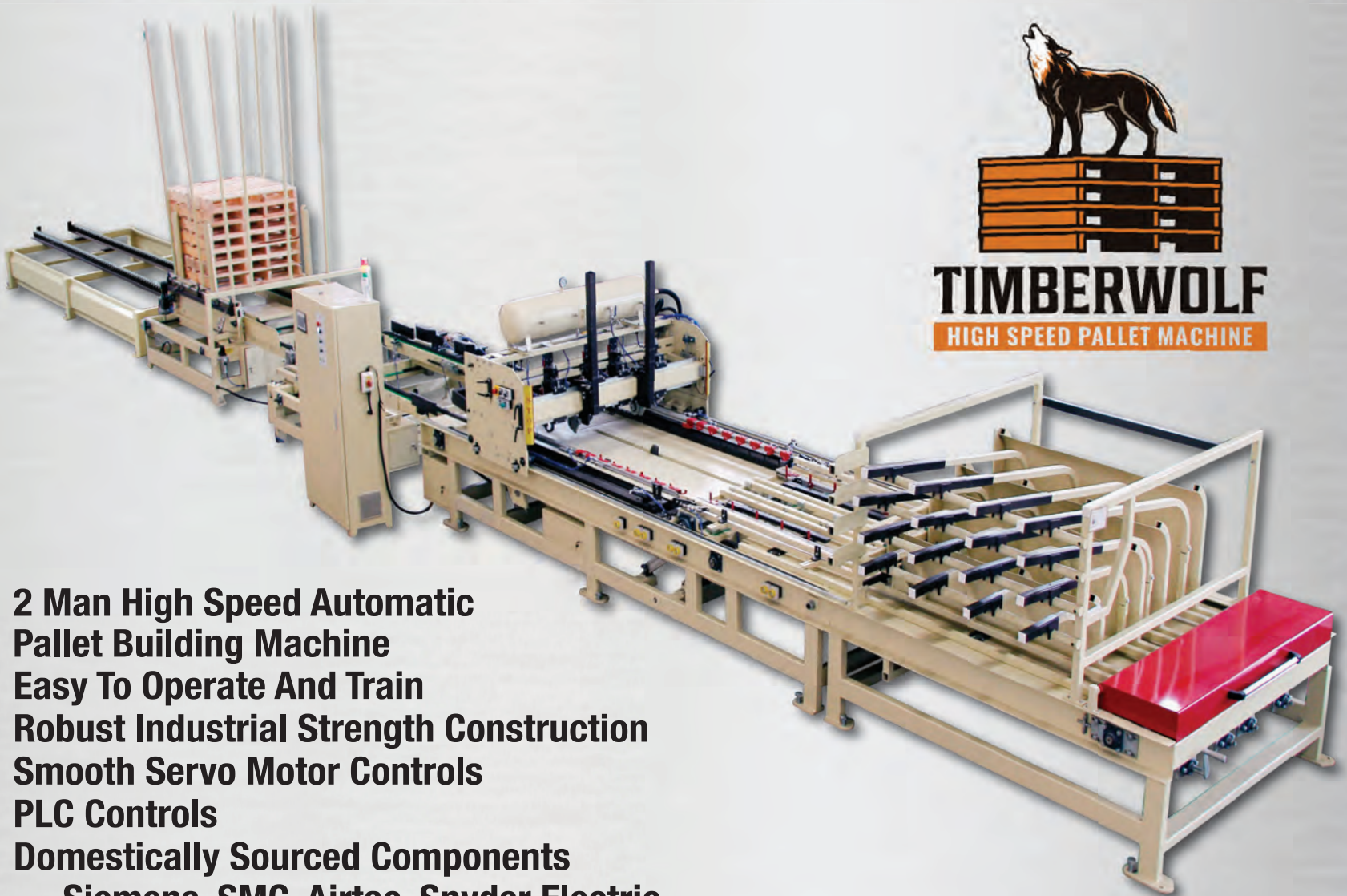

- 2 Man High Speed Automatic Pallet Building Machine
- Easy To Operate And Train
- Robust Industrial Strength Construction
- Smooth Servo Motor Controls
- PLC Controls
- Domestically Sourced Components  
— Siemens, SMC, Airtac, Snyder Electric
- Domestic Support Team

**And despite the current supply chain problems, the Timberwolf is available with just a 5 month lead time!**



***RESERVE YOURS TODAY...***  
***501-679-6814***

***viperindustrialproducts.com    cs@viper-us.com***

# Public Online Auction Columbia Cedar

Surplus Mill Equipment **Columbia Cedar**

**Start Date:** 11AM | Wednesday - May 18

**End Date:** 11AM | Wednesday - May 25

**Preview:** 8AM to 4PM | Tuesday, May 24

**Location:** 24419 US 395, Kettle Falls, WA 99141

**Murphyauction.com for more information!**



LETSON BURPEE  
6' RH VERTICAL BAND HEAD RIG



SALEM  
APPROX. 32"X16' 3-KNEE RH  
TEMPOSONIC POSITIONED CARRIAGE



INOVEC YIELDMASTER  
20' CARRIAGE OPTIMZIER



CM&E 34 RH  
8-KNIFE TEMPOSONIC POSITION  
SLABBER



APPROX. 40' 5-STRAND H-CHAIN  
INFEED LOG DECK



SALEM  
5' TWIN HORIZONTAL BAND  
TEMPOSONIC POSITIONED RESAW



KOCKUMS  
APPROX. 58" 8-KNIFE CHIPPER



MILLPOWER  
APPROX. 18"X42"  
BALANCED VIBRATORY CONVEYOR



2006 KAESER OMEGA 83  
ROTARY LOBE BLOWER



Located in  
Arden, WA

2003 USNR  
APPROX. 16' LUG LOADER



BM&M  
8'X8' 2-DECK CHIP SCREEN



QUINCY MG SERIES  
30 HP ROTARY SCREW COMPRESSOR



Located in  
Moses Lake, WA

LAMB  
PEDISTAL MOUNTED  
HEEL BOOM LOG LOADER



Located in  
Moses Lake, WA

WSM  
40' BALANCED VIBRATORY CONVEY



Located in  
Moses Lake, WA

JEFFREY 44WB  
HAMMER HOG



SCHURMAN 8SBA30  
OPTIMIZED GANG EDGER



DAEWOO  
TRACKED MOUNTED LOG LOADER

James G Murphy Co. - [Murphyauction.com](http://Murphyauction.com) - 425-486-1246 - [Murphyauction.com](http://Murphyauction.com) For Full Preview

# Public Online Auction

JEM MACHINE, INC.

Logging & Mill Equipment

**Start Date:** 11AM | Tuesday - June 7

**End Date:** 11AM | Tuesday - June 14

**Preview:** 8AM to 4PM | Monday, June 13

**Location:** 820 N. Florence St., Grangeville, ID 83530

PREVIEW AVAILABLE BY APPOINTMENT

**Murphyauction.com for more information!**



NICHOLSON A-5  
27" REFURBISHED RIGHT HAND DEBARKER



WARREN BAERG W-350  
CUBER



WARREN BAERG  
20" X 12' MIXING CHAMBER



SCHUTTE HZF-40  
HAMMER MILL



VK/LINSEY  
18" SELF CENTERING INFEED



PRENTICE 620 FB  
FELLER BUNCHER



DRESSER TD-25



THUNDERBIRD 836



THUNDERBIRD 1236



QUADCO QFH



1976 CATERPILLAR 235



CASE 480C



HYSTER 90



1996 BIG TEX  
16' T/A GOOSENECK TRAILER



(1 OF 2)

PEERLESS  
T/A LOG TRAILER



2006 WESTERN STAR 4900 FA 9



1989 PETERBILT 377



WARREN BAERG TWIN 9" FEED  
AUGERS FEED MODULE



NICHOLSON 27" REFURBISHED  
CAPTIVE BEARING



LARGE ASSORTMENT OF  
NICHOLSON ROLLS



GEAR HEAD MOTORS & SPEED  
REDUCERS

James G Murphy Co. - [Murphyauction.com](http://Murphyauction.com) - 425-486-1246 - [Murphyauction.com](http://Murphyauction.com) For Full Preview

# Public Online Auction

## R-Y TIMBER, INC.

Sawmill

**Start Date:** 11AM | Thursday - June 16

**End Date:** 11AM | Thursday - June 23

**Preview:** 8AM to 4PM | Wednesday, June 22

**Location:** 85 Mill Road, Townsend, MT 59644

**Murphyauction.com for more information!**



WAGNER L90

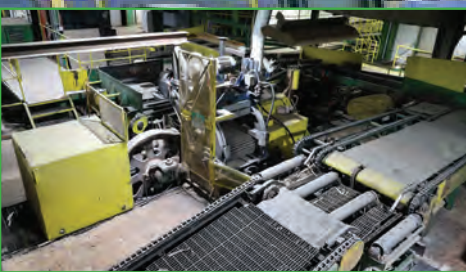

LETSON BURPEE  
5' SINGLE HORIZONTAL BAND RESAW



(1 OF 2)

KOCKUMS 24" CAMBIO  
5-ARM RING DEBARKER



2018 USNR MILL EXPERT G3  
CHROMASCAN 2460



ADCO WEST VSLM  
TIMBER SIZER



60" INSERT TOOTH WHOLE LOG  
CUT OFF SAW



(1 OF 2)

MDI TWA2000.38"X47" WHOLE  
LOG METAL DETECTOR



DIAMOND DOUBLE COLUMN 8' RH  
HEAD RIG BANDMILL



SCHURMAN 8"X66" SPLINED  
BOTTOM ARBOR GANG EDGER



(2) SIMPLE SIMON STYLE  
STUD STACKERS



2001 TMT 4"X30" SPLINED TOP  
ARBOR BOARD EDGER



(2) PEERLESS



KOCKUMS  
8'X8' 2-DECK CHIP SCREEN



KOCKUMS 58  
58" 8-KNIFE CHIPPER



VIBRA-PRO 24"X70' BALANCED  
VIBRATORY CONVEYOR



SIMONDS KR0970  
CIRCLE SAW LEVELER



ARMSTRONG SUPER DUTY



CAT D7



CAT 12G



CAT EL240



CAT 988B

James G Murphy Co. - [Murphyauction.com](http://Murphyauction.com) - 425-486-1246 - [Murphyauction.com](http://Murphyauction.com) For Full Preview

# CEMARLINE®

cemarelectro.com 1.800.298.5273



- 5, 15, 30, or 50 mW
- **Red** or **green** options
- Industrial strength
- Patented linear optics
- 48-hour repair service
- **Powershift™** technology
- 2-year warranty

## LASERS

FOR TOUGH SAWMILL ENVIRONMENTS

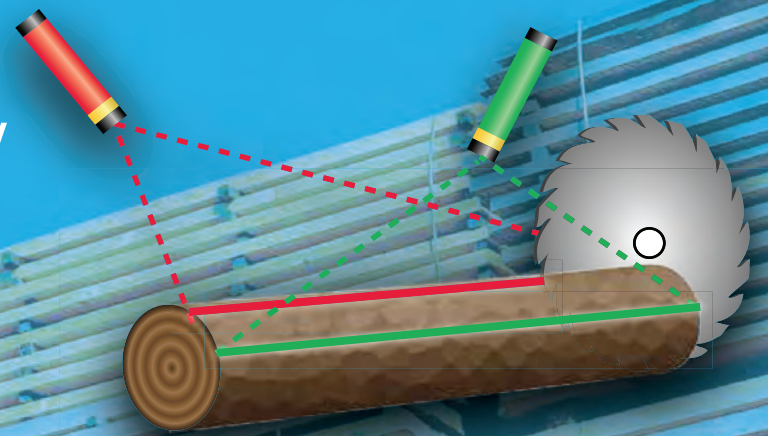

The Original American Forestry Show

# THE PAUL BUNYAN SHOW

888-38-TREES | OHIOFOREST.ORG

## OCTOBER 7-9, 2022

GUERNSEY CO. FAIRGROUNDS | CAMBRIDGE, OHIO

THE OFFICIAL PAUL BUNYAN SHOW

Husqvarna

INSPIRED BY TRADITION. POWERED BY INNOVATION. THE OHIO FORESTRY ASSOCIATION

# Your Most Reliable Source for New, Used & Customized Machinery. Call Mona Tracy Today!



The **RUN-A-GADE** Bandsaw Pallet Disassembly System

## **BANDSAW DISASSEMBLERS!**



**TRIO**  
3-Head

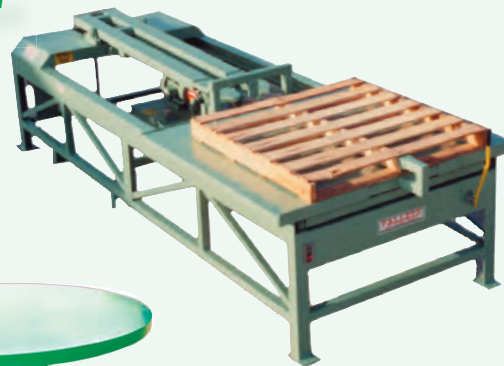

**SOLO**  
Single Head



**MARK I**  
Bandsaw Disassembler

Make it a complete system with a round table



## **DISC TYPE DISASSEMBLERS!**



**Manual**  
Chop Saw



**TRIM TRAC**  
End Trim Saw

## **LUMBER SAVERS!**



**High Speed Pop-Up**  
Cut-Off Saw



**SN-20 Automatic Notcher**



**SN-10 Manual Notcher**

## **NOTCHERS!**



**UNIVERSAL**  
MACHINERY SALES, INC.

Call Mona Tracy

**Toll Free 1-855-298-8890**  
or **812-298-8090**



- Package/Yard Saw (NEW!)
- Corner Rounder
- Chamfer
- Unstubber
- Pallet Sizer
- Round Tables
- Specialty Machinery

www: [universalmachinerysales.net](http://universalmachinerysales.net)

E-Mail: [sales.universalmachinerysales@gmail.com](mailto:sales.universalmachinerysales@gmail.com)

**Leasing & Financing Available**

# The Most Innovative Equipment is a Phone Call Away..



**Wide Cut  
RESAW**

**Low Profile  
BAND RESAW**  
*Single & Multi-Head Models*



**ANGLE CHOP SAW**  
*Cuts 0° to 45° on a 2x8  
and 0° to 40° on a 2x10  
Fast Cycle*



**Robo Chop  
UPCUT SAW**  
*Automatic push feeder, 30,000 B. F./shift.  
Stacks boards 5 high & up to 16 wide.  
Up to 18 ft lengths*



**Military  
BAND NOTCHER**  
*Fully Adjustable notch-length of board  
Option: Single or Double Cut*



**Hopper Feed  
DOUBLE END  
TRIM SAW**  
*Processes 47 boards per minute!  
Accepts 1/2" to 2" thick boards  
(2) 10" blades, optional 12" blade*



**Multi-Head TRIM SAW**  
*2, 3, 4 or 5 head models  
Adjustable heads with variable speed,  
chain feed drive motor w/starter*



**Incline  
Trim-Trac  
END TRIM SAW**  
*Production rate up to  
15,000 boards per 8 hr. shift!  
16" to 56" lengths*



**STAKE  
MACHINERY**  
*Pencil Point Style*



**Self  
Dumping  
STEEL HOPPERS**



**BOARD  
DUSTER**

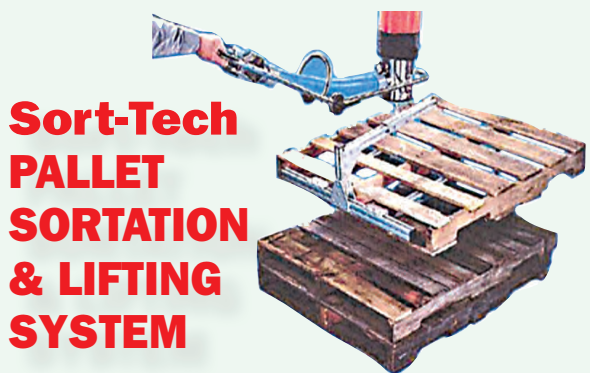

**Sort-Tech  
PALLET  
SORTATION  
& LIFTING  
SYSTEM**



**REPAIR BARS!**  
*Call for Pricing!*



**SCISSOR LIFTS**  
*2,000 - 8,000 lbs.*



**BLOWERS!**



**Call Eugene:  
260.250.4597**

Call 574.825.0704 to receive the Bright Star Bid Book for FREE. This is a detailed catalog that also allows you to bid on the phone if you can't bid online.



Accepting consignments of sawmill, logging, and heavy equipment for this annual auction. Consign early to take advantage of our free to you advertising. See other ads in this issue for more consigned items!

**Sellers: Various Consignors**

260 Elkin Wildlife RD  
Elkin, NC 28621

**Annual  
Appalachian  
Consignment  
Auction**

May 12th 10 AM



**Chevy Dump Truck**



**2016 CAT 926M  
Wheel Loader**

**No  
Minimums! No  
Reserves!**



**John Deere Knuckleboom**



**John Deere Feller Buncher**



**CSI 264 Ultra Delimber**



**2011 John Deere  
328D Skid Steer**

2011 John Deere 328D Skid Steer, John Deere Skid Steer Bucket, Toyota Forklift, 2016 CAT 926M Wheel Loader, 2005 Volvo L120E Wheel Loader, 2007 Volvo L70F Wheel Loader, Allis Chalmers Wheel Loader, 2016 CAT Self Dumping Bucket, CAT Wheel Loader Buckets, Wheel Loader Forks, John Deere 437C Knuckleboom, 1998 Prentice 410EX Knuckleboom, CTR Bucksaw CSI 264 Ultra Delimber, CTR Bucksaw, CTR Bucksaw, Timberjack 380 Grapple Skidder, Timberjack 230E Skidder, 2018 Tigercat H822D Harvester w/ Tigercat 575 Harvesting Head, John Deere 843G Feller Buncher, 2019 Tigercat 1055C Forwarder, 2011 John Deere 200D Excavator, 2017 John Deere 350G Excavator, Hitachi ZX225US LC-3 Excavator, 2014 John Deere 700K XLT Crawler Dozer, John Deere 850J LGP Crawler Dozer, 2003 McCormick TTX230 Xtra Speed Tractor, Bandit 2590 Portable Chipper, Bandit 2290 Electric Chipper, 2000 Kenworth T800 Service Truck, 2011 Peterbilt 386 Truck, 2003 Freightliner Columbia 120 Truck, 1993 Peterbilt 377 Truck, Kenworth T800 Day Cab, Kenworth T800 Day Cab, 2001 International 4800 Truck, 1983 GMC Brigadier Truck, 2007 Chevrolet C5500 Service Truck, 2008 Dodge Ram Truck Pickup Truck, Chevy Dump Truck, 2008 Ford F-550 Service Truck, 1999 Ford F-450 Service Truck, 1995 Ford F-450 Service Truck, 2018 Talbert Lo-Boy Trailer, Dorsey Flatbed Trailer 1992 Peerless Trailer, 45' Chip Trailer, Big John Knuckleboom Trailer, 2013 Quality Equipment Trailer and much more!



**Main Office  
574.825.0704  
AC32100007**



**Eugene Hochstetler  
260.250.4597  
AU11400005**



*10% buyer's premium for onsite bidders. All items must be paid in full before removal*  
**See brightstarauctions.com for online bidding and more...**





**Sellers: Various Consignors**

260 Elkin Wildlife RD  
Elkin, NC 28621

# Annual Appalachian Consignment Auction

May 12th 10 AM

**Call Eugene:  
260.250.4597**

Call 574.825.0704 to receive the Bright Star Bid Book for FREE. This is a detailed catalog that also allows you to bid on the phone if you can't bid online.

Accepting consignments of sawmill, logging, and heavy equipment for this annual auction. Consign early to take advantage of our free to you advertising.



2011 John Deere 200D Excavator  
8054 hours!



John Deere 850J LGP Crawler  
Dozer 3348 hours!



2017 John Deere 350G Excavator  
3720 hours!



Hitachi ZX225US LC-3 Excavator  
5380 hours!



2003 McCormick TTX230 Xtra  
Speed Tractor 290 hours!



2014 John Deere 700K XLT  
Crawler Dozer 4746 hours!

**No  
Minimums! No  
Reserves!**



**Main Office  
574.825.0704  
AC32100007**



**Eugene Hochstetler  
260.250.4597  
AU11400005**



10% buyer's premium for onsite bidders. All items must be paid in full before removal

**See brightstarauctions.com for online bidding and more...**

**Call Eugene:  
260.250.4597**

Call 574.825.0704 to receive the Bright Star Bid Book for FREE. This is a detailed catalog that also allows you to bid on the phone if you can't bid online.



Accepting consignments of sawmill, logging, and heavy equipment for this annual auction. Consign early to take advantage of our free to you advertising.

**Sellers: Various Consignors**

260 Elkin Wildlife RD  
Elkin, NC 28621

**Annual  
Appalachian  
Consignment  
Auction**

**May 12th 10 AM**



**2005 Volvo L120E Wheel Loader  
10,084 hours!**



**2016 CAT 926M Wheel Loader  
5627 hours!**



**2007 Volvo L70F Wheel Loader  
17,917 hours!**



**Bandit 2290 Electric Chipper**



**2018 Tigercat H822D Harvester w/  
Tigercat 575 Harvesting Head  
4216 hours!**

**No  
Minimums! No  
Reserves!**



**Bandit 2590 Portable Chipper  
2260 hours!**



**2019 Tigercat 1055C Forwarder  
5598 hours!**



**Main Office  
574.825.0704  
AC32100007**



**Eugene Hochstetler  
260.250.4597  
AU11400005**



*10% buyer's premium for onsite bidders. All items must be paid in full before removal*  
**See brightstarauctions.com for online bidding and more...**



**Call Eugene:  
260.250.4597**

Call 574.825.0704 to receive the Bright Star Bid Book for FREE. This is a detailed catalog that also allows you to bid on the phone if you can't bid online.

Accepting consignments of sawmill, logging, and heavy equipment for this annual auction. Consign early to take advantage of our free to you advertising.

**Sellers: Various Consignors**  
260 Elkin Wildlife RD  
Elkin, NC 28621  
**Annual  
Appalachian  
Consignment  
Auction**  
May 12th 10 AM

**No  
Minimums! No  
Reserves!**



**Kenworth T800  
Day Cab**



**2003 Freightliner  
Columbia 120 Truck**



**2007 Chevrolet  
Service Truck**



**2011 Peterbilt Truck**



**2008 Dodge Ram Truck**



**2018 Talbert  
Lo-Boy Trailer**



**1992 Peerless Trailer**



**1993 Peterbilt 377 Truck**



**2005 Wilkens Walking  
Floor Trailer**



**2000 Kenworth T800 Service Truck**



**Dorsey Flatbed Trailer**



**Main Office  
574.825.0704  
AC32100007**



**Eugene Hochstetler  
260.250.4597  
AU11400005**



*10% buyer's premium for onsite bidders. All items must be paid in full before removal*  
**See [brightstarauctions.com](http://brightstarauctions.com) for online bidding and more...**

# Annual Appalachian Consignment Auction-May 12 10AM



The auction will be held at Pirates Landing Restaurant (161 Interstate Way Elkin, NC 28621). Bright Star has reserved 30 rooms at Hampton Inn for auction attendees. The price is \$109 per night. When you call to reserve your room, mention that it is for the Bright Star auction.

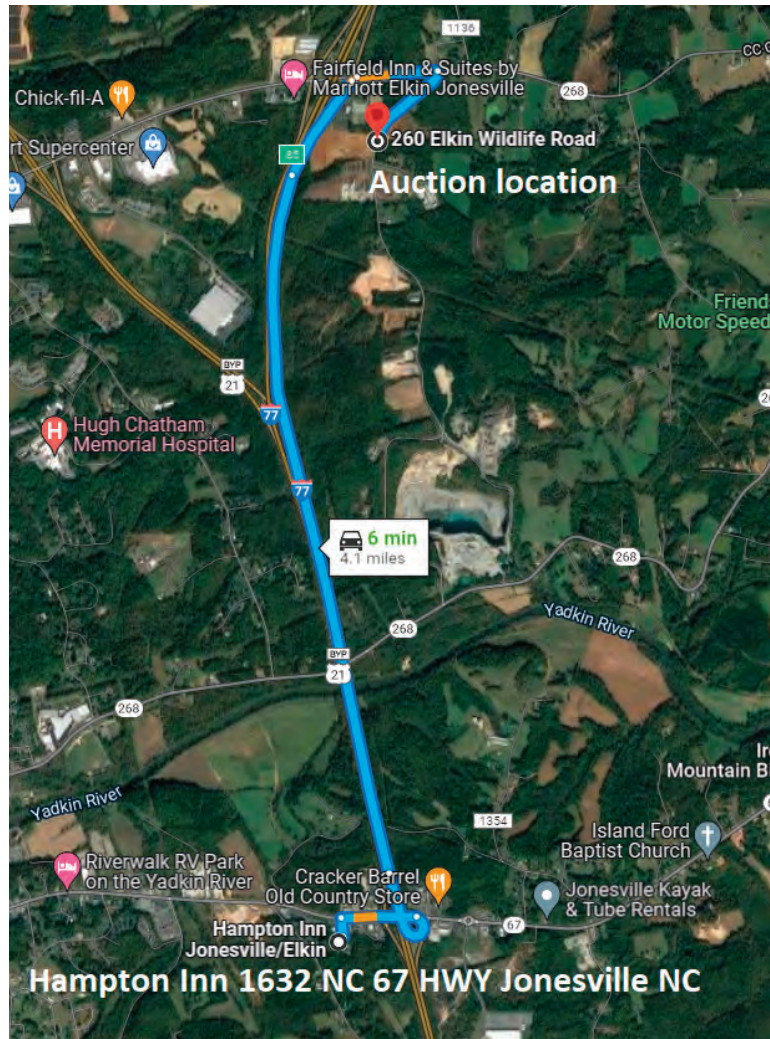

**Main Office**  
574.825.0704  
AC32100007

**Hampton Inn:**  
336.835.1994

**Call Zach:**  
931.322.4632

Call 574.825.0704 to receive the Bright Star Bid Book for FREE. This is a detailed catalog that also allows you to bid on the phone if you can't bid online.



**Complete Sawmill Line!**

**No Minimums! No Reserves!**

**Seller: Kiser Lumber Company**  
6903 Vance Rd  
Bowman, SC 29018  
**Sawmill Equipment Auction**  
June 16th  
9 AM



**Main Office**  
574.825.0704  
AC32100007



**Zach Kitrell**  
931.322.4632  
LIC#1959



10% buyer's premium. All items to be paid in full within seven days and before removal.

**See brightstarauctions.com for online bidding and more...**

**Call Jonathon:  
574.444.2791**



Sellers: Countryside Buildings LLC  
Summersville, MO  
**Complete Mini Barn Business For Sale**  
as an entire operation

Auctioneer's Note: Countryside Buildings is a turn key portable building manufacturer located in Summersville, MO. Very profitable, well run business with 8 local dealer lots and has displays in 16 different Lowes stores in Arkansas. Includes all equipment, inventory, 1.8 acres real estate. 52 x 80 building with updated offices.



**Very Profitable!**



**Complete Operations!**



**Main Office  
574.825.0704  
AC32100007**



**Jonathon Miller  
574.444.2791  
Auction Agent**



**See [brightstarauctions.com](http://brightstarauctions.com) for more information...**

**Call Jonathon:  
574.444.2791**

**Real Estate  
available  
as well**



1973 Peterbilt 359M

**Sellers: Shingleton's Sawmill**

1432 Ford Hill Rd  
Augusta, WV 27644

**Sawmill &  
Woodworking  
Equipment  
Auction**

**May 18  
10 AM EDT**



Raimann ProfiRip KM  
310M Gang Rip Saw



1993 Kenworth Day Cab



Weinig P-23 Moulder



Brewco Edger Splitter



Northtech EL610 Double  
Surface Planer

**No  
Minimums! No  
Reserves!**



2004 Mac Flatbed Trailer



Ingersoll Rand Air  
Compressor



Grizzly G0569 Bandsaw



Fulghum 6-Knife 60" Chipper

**Trucks and  
Trailers!**



Fulghum Shaker Screen



Chicago Pneumatic  
Air Compressor

Call 574.825.0704 to receive the  
Bright Star Bid Book for FREE.  
This is a detailed catalog that  
also allows you to bid on the  
phone if you can't bid online.



**Main Office  
574.825.0704  
AC32100007**



**Jonathon Miller  
574.444.2791  
Auction Agent**



10% buyer's premium. All items to be paid in full within seven days and before removal.

**See brightstarauctions.com for online bidding and more...**

**Call Jonathon:  
574.444.2791**



Cat 518 Cable Skidder



Cat 955L Track Loader



Cat D4D Dozer



Mack Elite CL Boomtruck

**Sellers: Bowser Lumber Co.**  
 8530 Colonel Drake Hwy.  
 Mahaffey, PA 15757

**Sawmill &  
 Logging  
 Equipment  
 Auction**

**May 19  
 10 AM EDT**

**Mack  
Trucks!**

**No  
Minimums! No  
Reserves!**



1995 International F-9370 Truck



1983 Mack RD688S Tri-Axle Dump Truck



Cat 930 Wheel Loader



Ravens Fleel Hawk Aluminum Flatbed Trailer



Warner & Swasey Forklift



EMC AC40 Carriage



Reckart Gang Edger 642

Morbark Chip-Pac



Road Gear Flat Bed Trailer

Call 574.825.0704 to receive the Bright Star Bid Book for FREE. This is a detailed catalog that also allows you to bid on the phone if you can't bid online.



**Main Office  
574.825.0704  
AC32100007**



**Jonathon Miller  
574.444.2791  
Auction Agent**



10% buyer's premium. All items to be paid in full within seven days and before removal.

**See brightstarauctions.com for online bidding and more...**

### Featuring these liquidations:

- Buckeye Mouldings
- Foster's Logging
- Waverly, OH equipment
- Newport, OH equipment
- Griffin Lumber
- This auction has 10 NICE portable band mills, lots of sawmill equipment, rolling stock, woodworking equipment and lumber.
- Lots 1000-2000 will be selling on Friday, May 20. Lot numbers 2000 and up will be selling Saturday, May 21.



CAT IT24 Wheel Loader

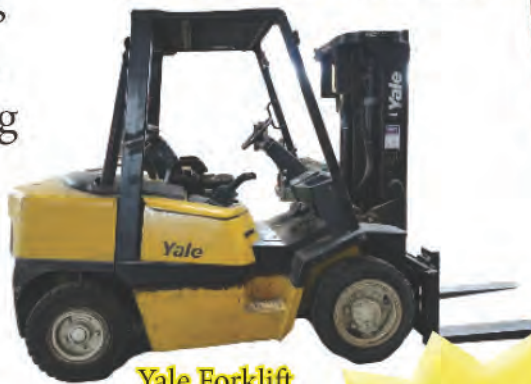

Yale Forklift



JCB 930 Forklift



Terex 60C Wheel Loader



Hyster 200 Forklift



Case 855C Track Loader



John Deere Power Unit



Onan 150 KW Genset



2002 Timberjack 430B Knuckleboom



1999 Chevrolet C6500 Truck

Sellers: Various Consignors

Online & Phone Bidding Only

# Bright Star 2 Day May Virtual Equipment Auction

May 20 & 21  
10 AM EDT

**No  
Minimums!  
No Reserves!**

**2 Day  
Event!**

Call 574.825.0704 to receive the Bright Star Bid Book for FREE. This is a detailed catalog that also allows you to bid on the phone if you can't bid online.



*The March and April auctions were a smashing success and had consignors from these states: WV, KY, VA, IN, IL, GA, PA, MI, WI, TN, ID, FL, NY, AL, SC, NC, NJ, IA and OH! Looking for sawmill, heavy equipment, forestry, metalworking, and woodworking consignments. Do you have equipment you need to move but not enough for an onsite auction? From one piece to complete operations, we can help! We will advertise your item at no cost to you, including in our Bright Star Bid Book. All equipment will be sold in place with the pick up address provided.*



**Main Office**  
574.825.0704  
AC32100007



**Eugene Hochstetler**  
260.250.4597  
AU11400005



13% buyer's premium. All items to be paid in full within seven days and before removal.

**See brightstarauctions.com for online bidding and more...**





Morgan 2 Head Resaw



Yates American A20 Planner



Kilntek Dry Kiln



Steel Frame Building



Armstrong #4 Profiler



2004 Wood-Mizer LT40 Super Hydraulic Portable Sawmill



2019 LT40 HD Super Hydraulic, fully loaded, Yanmar Diesel



Realtuff Shavings Baler



Ingersoll-Rand Air Compressor



Morgan Style Chopsaw



1995 Wrangler 6 Horse Trailer

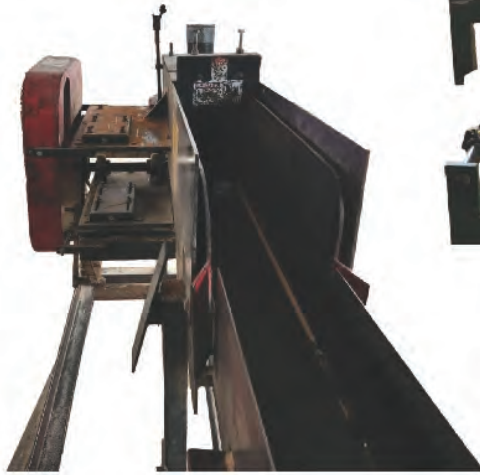

Morgan Deduster



HMC Rosserhead Debarker



Husky-Brute XL1755 Knuckleboom



Nicholson A5 Ring Debarker

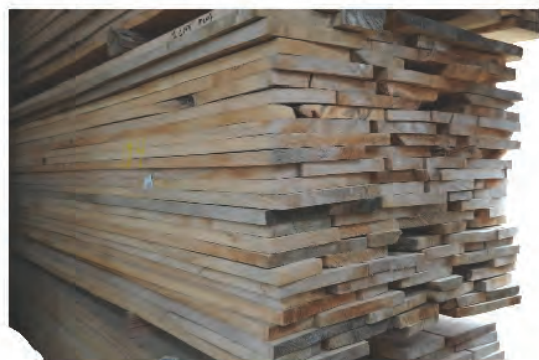

Lots of Lumber!



Cook's Edger

**Call Dan:  
330.749.9478**

**35+ lots  
of assorted  
lumber!**



Mereen Johnson  
Gang Rip Saw



Kubota Diesel Engine



Northwood Moulder



Industrial 14"  
Upcut Saw



Lots of Lumber!

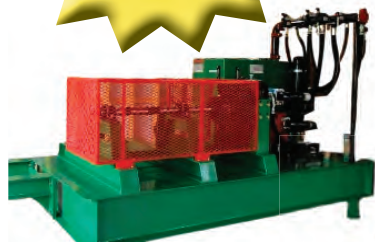

Hydraulic system on  
skid (new in 2019)



Snow Heavy duty  
Drill Press



Rye Copy shaper



Herm. Reichenbacher 6  
Head vertical  
drilling machine



Self-Dumping Hopper



2004 Routech 4  
Axis CNC Router



Stonewood GS-523 Pro  
Series 5-Head Moulder



Steel Table with 2  
Drill Presses



Detroit Diesel Series  
60 Power Unit



Oliver Straitoplane  
double sided Planer

**Seller: Buckeye Mouldings**  
Online & Phone  
Bidding Only  
**Part of the 2  
day May Virtual  
Equipment  
Auction**  
May 20 and 21  
9 AM EDT

This quality equipment is located at 17116 Bundysburg RD, Middlefield, OH 44062 and is lots 2100-2190 in the May Virtual Auction. This liquidation will be selling on Saturday.

**No  
Minimums!  
No Reserves!**

Call 574.825.0704 to receive the Bright Star Bid Book for FREE. This is a detailed catalog that also allows you to bid on the phone if you can't bid online.



**Main Office  
574.825.0704  
AC32100007**



**Dan Troyer  
330.749.9478  
Auction Agent**



13% buyer's premium. All items to be paid in full within seven days and before removal.

**See brightstarauctions.com for online bidding and more...**

May 20 and 21,  
2022 10 AM

Online and Phone  
Bidding Only

# Lots 2202 and 2300-2316 in the May Virtual Auction

Call Tim:  
269.986.5693

**Seller: Fosters Logging - Equipment located in Allen, MI**  
This equipment will be selling Saturday May 21



Jockey Grinder



Dewalt Chop Saw



Renco 3 Blade  
Vertical Edger



Roll Case



CAT IT24 Wheel Loader

Call 574.825.0704 to receive the Bright Star Bid Book for FREE. This is a detailed catalog that also allows you to bid on the phone if you can't bid online.



**Main Office  
574.825.0704  
AC32100007**



**Tim Graber  
269.986.5693  
Auction Agent**



13% buyer's premium. All items to be paid in full within seven days and before removal.

**See brightstarauctions.com for online bidding and much more...**

**Call Jonathon:  
574.444.2791**

Call 574.825.0704 to receive the Bright Star Bid Book for FREE. This is a detailed catalog that also allows you to bid on the phone if you can't bid online.



Newport OH Sawmill/Planing Liquidation  
Online & Phone Bidding Only  
**Part of the 2 day May Virtual Equipment Auction**  
May 20 and 21  
9 AM EDT



Kilntek Dry Kiln



Steel Frame Building



Yates American A20 Planer/Moulder



AEM 3 Head Sander

No Minimums!  
No Reserves!



Diehl Straight Line Rip Saw/Planer

Lumber racks!

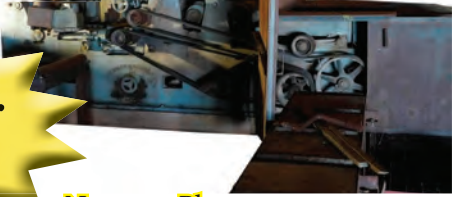

Newman Planer



Swinging Arm Chopsaw



Corley 9 Head Drop Trim Saw

Lumber carts!



Randamat 931 Profile Grinder



Fulghum Shaker Screen



Cornell Gang Saw



Crosby 3 Blade Edger



Salem 8' Head Rig



Rosserhead Debarker

Concave Belt Conveyors, Barn Sweep, 4 Strand Log Decks w/ Stop'N'Load, Mellott 42" Chain Type Log Turner, 75 hp Hydraulic pack, Laser Light Control System, Rollcase w/ 4 Strand Pop-Up Transfer, 3 Strand Incline Transfer Deck, 3, 4 and 5 Strand Transfer Decks, 3 and 4 Strand Green Chains, Infeed for Gang Saw, Outfeed Rolls for Gang Saw, Rollcase w/ 5 Strand Transfer, Maxon 26" Blower, 4 Strand Decline Transfer Deck, Mellott Vibrating Conveyor, 5' Cyclone, Lincoln Electric Motor, 42" Blower, Dust House, Lumber Carts, Lincoln Shield Arc Welder, Steel Banding, 275 Gallon Fuel Tank, 55 Gallon barrel of oil w/ pump, Bandsaw Blades, Newman Knife Grinder, Tool chest, Band Saw Stretcher, Wooden Lumber Carts, Corley Unscrambler, Brilliant Fire Heater, Steel shelves and Lights, Hardinge Dove-Tail Bed, Tropicana Vending Machine, Gearbox and Roll, Buss Planer, 2 Blowers, Grinder, Ingersoll-Rand Air Tank w/ Electric motor, Cut Off Saw, Galvanized Dust Pipe, Stacking System, Reckart 26" Blower, Simplec Upcut Saw, Dust Pipe and Blowers, Open Sided Steel Buildings, Steel Frame Buildings, Pallet Jack and Electric motor, Viking Jet-A-Way Pressure Washer, Fuel Tank, Hydraulic Tank, Bolt bins, LP Tank, Lumber Rack w/ Stacking Sticks, Pallets, and much more!



Main Office  
574.825.0704  
AC32100007



Jonathon Miller  
574.444.2791  
Auction Agent



13% buyer's premium. All items to be paid in full within seven days and before removal.

See [brightstarauctions.com](http://brightstarauctions.com) for online bidding and more...



**Call Eugene:  
260.250.4597**

**These Quality Bandmills  
and more will sell on  
Saturday, May 21.**

**Sellers: Various Consignors**  
Online & Phone  
Bidding Only  
**Bright Star  
May Virtual  
Equipment  
Auction**  
May 20 & 21  
10 AM EDT



**2004 Wood-Mizer LT40  
Super Hydraulic Portable  
Sawmill**



**LT70 Wood-Mizer, 2017,  
3887 hrs! fully hyd. fully  
loaded, debarker, excellent  
con. 55 HP Yanmar Diesel**



**Wood-Mizer LT 70  
Portable Sawmill**



**2020 Timber Buddy XP380  
Thin Kerf Band Mill**

**No  
Minimums! No  
Reserves!**



**2017 Wood-Mizer LT40  
Hydraulic Portable Sawmill**



**LT40 HD Woodmizer  
Bandmill**



**2021 Wood Mizer BMS250  
sharpener, LIKE NEW!!**



**2014 Baker 3665D  
Band Mill**

**2 Day  
Auction!**

**2019 LT40 HD Super  
Hydraulic, fully loaded,  
Yanmar Diesel**



**Wood-Mizer LT40  
Portable Bandmill**

**Call 574.825.0704 to receive the  
Bright Star Bid Book for FREE.  
This is a detailed catalog that  
also allows you to bid on the  
phone if you can't bid online.**

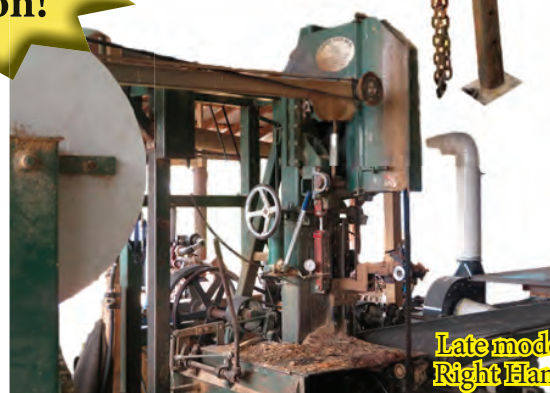

**Late model Lumber Tiger  
Right Hand 411B carriage**



**Main Office  
574.825.0704  
AC32100007**



**Eugene Hochstetler  
260.250.4597  
AU11400005**



*13% buyer's premium. All items to be paid in full within seven days and before removal.*

**See brightstarauctions.com for online bidding and more...**

**Call Eugene:  
260.250.4597**

Lots 2206, 2207 and 1317 - 1347.  
This liquidation will be selling mostly on Fri. with the exception of the rolling stock which will be sold on Sat.



Meadows #1 Deluxe 4 HB Carriage



JCB 930 Forklift

**No Minimums!  
No Reserves!**



Case 855C Track Loader



Self Dumping Hopper



John Deere 6081 Power Unit



ChopSaw



John Deere 4039 Power Unit



Pendu 36" Blower

Call 574.825.0704 to receive the Bright Star Bid Book for FREE. This is a detailed catalog that also allows you to bid on the phone if you can't bid online.



**Main Office  
574.825.0704  
AC32100007**



**Eugene Hochstetler  
260.250.4597  
AU11400005**



13% buyer's premium. All items to be paid in full within seven days and before removal.

**See brightstarauctions.com for online bidding and more...**

### Bright Star Equipment Consignment Auction

July 1st 2022

**Call Bronson:  
574.210.3721**

Now taking consignments for the July 1 auction!

**Consign Now!**



Sold for \$30,000!



Sold for \$100,000!



Sold for \$99,000!



Sold for \$42,500!

Results from April 1 Auction

### Real Estate and Equipment At Auction!

Williamsfield, OH  
September 15  
2022 10AM

**Call Eugene:  
260.250.4597**



**Bronson Gangwer  
574.210.3721  
AU11900021**



**Eugene Hochstetler  
260.250.4597  
AU11400005**

**See brightstarauctions.com for more information...**

**See brightstarauctions.com for more information...**

**Call Jonathon:  
574.444.2791**



Polley Lane Sawmill is a complete turn key sawmill operation including rolling stock and real estate. Currently in full production. Adjoining homestead with 52 acres will also be available to the buyer of the business.

**Sellers: Polley Lane Sawmill**

**N2916 River Road  
Gillman, WI  
54433**

**Complete  
Sawmill  
Business  
For Sale**

**as an entirety**



**Business  
for Sale!**



Assets: 2016 John Deere 304K Wheel Loader, 2012 Cat 5000 lb. Forklift, TCM 5000 lb. forklift, Franklin 132 Forwarder, 2- Sawdust wagons, 16' gooseneck trailer, 14' dump trailer, Log deck, Corley handset mill, Sierra 10 HP screw air compressor, 6" x 36" Edger, 2 Head Baker resaw w/complete run-around, Single arbor gang saw, Baker unscrambler, Pro-cut chop saw, Double head notcher, Montgomery 26HD Blo-hog, 2-De-troit engines, 3- John Deere 4.5 engines, Banding tools, Well stocked parts room 6.6 Acres with 100' x 100' steel building.

**Complete  
Operations!**



**6 Acres!**



**Main Office  
574.825.0704  
AC32100007**



**Jonathon Miller  
574.444.2791  
Auction Agent**



**See brightstarauctions.com for more...**

# We Won't Just Sell You A Laser...



## When You Buy From Ellison, You'll Also Get:

- Lasers designed specifically for the sawmill industry
- Superior service/support after the sale
- Our 40+ years of laser expertise



OUR MOST POPULAR

## ELD-15

IS THE INDUSTRY STANDARD LASER FOR LONG LIFE & DURABILITY



- Built Sturdy with Superior Components for the Toughest Environments
- Unsurpassed Reliability
- 2-Year Warranty on Most Sold

CHECK OUT OUR **EGL SERIES** OF GREEN DIODE LASERS



- Most Economical
- Precise
- Enhanced Visibility



Shift Kits Available for Movable Saw Applications

Our lasers are made with more reliable and longer lasting American Components AND Craftsmanship!



# ELLISON SALES

**Toll-Free: 888-244-0161**

E-mail: [dan@ellisonsales.com](mailto:dan@ellisonsales.com) • [www.ellisonsales.com](http://www.ellisonsales.com)

# We Deliver When YOU Need It Most!



IN STOCK PARTS HAS A HUGE INVENTORY OF GEAR REDUCERS, ELECTRIC MOTORS, MOTOR CONTROLS, STARTERS, CHAINS, SPROCKETS, SHEAVES, BELTS, VFDS, COUPLINGS, BUSHINGS, BEARINGS & LOTS MORE!



Inline Gear Reducers



Integral Gearmotors



Shaft Mount Reducers



Right Angle Reducers



Bearings & Mounted Units



Electric Motors



Variable Frequency Drives



Contactors & Soft Starters



Fuses

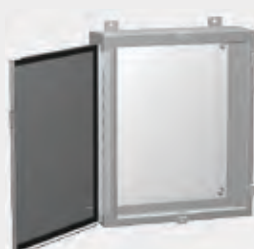

Enclosures

**Downtime costs you money. We specialize in getting your operation running again...FAST.**

**NEED IT NOW? YES, WE HAVE IT...IN STOCK.**



479-668-3141 • [www.instockparts.com](http://www.instockparts.com)  
[sales@instockparts.com](mailto:sales@instockparts.com) • Fort Smith, AR

**Rebuilt Chippers**



**(2) Precision 58" 6K Chippers**  
 Top or Bottom Discharge  
**(1) 58" Morbark Chipper,**  
 Top Discharge  
**800-598-6344**  
[info@smithsawmillservice.com](mailto:info@smithsawmillservice.com)

**RUMA'S**   
**PALLET WORLD LLC**  
 HEAT TREATED WHOLESALE PALLETS CASH FOR PALLETS  
 EUROS 48 X 40 RECYCLING  
 @RUMASPALLETWORLD  
 EMAIL: [pallets@umas.com](mailto:pallets@umas.com)  
 PH: 617-389-8093

**Cutting Innovation**  
 Cuts Logs & Lumber w/Articulating, Tracked & Skid Loaders etc.



Invented by a logger/lumberman for the timber industry  
 Patent Pending [yutzybarllc.com](http://yutzybarllc.com)  
**615-965-4060**  
[sales@yutzybar.net](mailto:sales@yutzybar.net)

   
 See us at outside booth A9 Outside Booth E1

**GUARANTEED WELDS!** Bandsaw Blades — Welded to your lengths.



Plus expert sharpening service!

For all primary & secondary wood processing operations.

Gang • Edger • Scragg Trim • Split • Strob

Plus expert sharpening service!

1" x .035	13'2" = \$13.57	<b>Ask about FREE Shipping. Also Volume Discounts.</b>
1 1/4" x .042	13'2" = \$16.95	
1 1/4" x .045	13'2" = \$17.41	
1 1/2" x .050	13'2" = \$21.55	15'4" = \$24.65
1 1/2" x .055	15'4" = \$26.63	17'4" = \$29.71
2" x .055	18'2" = \$37.94	20'4" = \$41.92

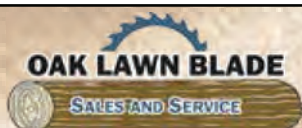

**Ph: 270-465-0192**  
**Fax: 270-465-0063**

**GREAT DEALS** on Used Equipment at **AMLUMBER.com!**

\*\*\*\*\* CERTIFIED APPRAISERS & BROKERS \*\*\*\*\*

**BUSINESS PLANNING & CONSULTING FOR RETIREMENT - RESTRUCTURE - PURCHASE OR SELL!**

A Kittrell Appraisal Can Help You With Making Life's Big Decisions. Maintain Your Peace of Mind.

**KITTRELL APPRAISALS**  
**931-698-3342**  
[www.kittrellappraisals.com](http://www.kittrellappraisals.com) • [info@kittrellappraisals.com](mailto:info@kittrellappraisals.com)  
 Fax: 931-231-1051 • Office: 931-797-6284 • TN #2293

Be sure you speak with **JACQUELINE KITTRELL**,  
 Owner, USPAP Appraiser, Real Estate Broker & Auctioneer



\*\*\*\*\* CERTIFIED APPRAISERS & BROKERS \*\*\*\*\*



# OPTIMAX Trim Saws

**“Our 3 Optimax Saws are real workhorses. We run 12,000 plus recycled deckboards a day on two of them and our third saw runs recycled stringers all day long. We could not be happier with their performance and endurance”.**

Jamie Gilbert  
Custom Pallet & Crating  
Charlotte, NC



CONTACT US TODAY TO  
FIND OUT HOW WE CAN  
ADVANCE YOUR BUSINESS  
THROUGH AUTOMATION



**866-546-8864**  
**PRSGroupInc.com**

Stackers - Conveyors - Dismantlers - Trim Saws - Band Saws - Splicers - Platers - More

# Sharpen Chipper Knives Onsite!

**Save time and money by sharpening knives in the chipper.**



**Over 30 years  
in business!**

- Extends the life of your knives
- Cuts sharpening costs by up to 75%!
- Less downtime means more time running and making money!

Different Models Available.  
In Operation Now For Brush  
Chippers, Whole Tree  
Chippers & In Sawmills, Chip  
Mills & Pulp Mills.



“Thanks for making such a great product. I recommended it to a couple people. This tool has increased my loads per knife set by 5-6 loads per sharpening.”  
~Bob Lussier - Great Woods Co., SC

“This tool works great. I don't know how I ever did without it.”  
~ Steve Warren, KY

**www.precisionsharpeningdevices.com • 814-899-0796 • info@precisionsharpeningdevices.com**

# PRECISION-CUT PALLET STRINGERS

## MAVERICK



•Pine •Aspen •Hardwood  
40" to 48" Length

[maverickwoodproducts.com](http://maverickwoodproducts.com)  
Browerville, Minn.

**SERVING MINNESOTA, THE DAKOTAS,  
IOWA, MISSOURI, WISCONSIN,  
ILLINOIS AND INDIANA**

**CALL 612-440-2028 FOR PRICING**



For Thin Kerf Saw Mills and Horizontal and Vertical Re-Saws

- Ultra Precision Ground Teeth
- Tight Tolerance Balanced Tooth Set
- State-of-the-Art Tooth Hardening

WoodMaxx and SuperMaxx7 Profiles and Sizes  
All sizes available in coil and welded to length

Width x Thickness (in)	MAXX10 10° Hook Angle				MAXX7 7° Hook Angle	MAXX4 4° Hook Angle	SuperMaxx7 7° Hook Angle 40° Back Angle
	Tooth Spacing				Tooth Spacing	Tooth Spacing	Tooth Spacing
	1/2" (2 TPI)	3/4" (1.3 TPI)	7/8" (1.1 TPI)	1" (1 TPI)	7/8" (1.1 TPI)	7/8" (1.1 TPI)	7/8" (1.1 TPI)
1 x .042		*					
1-1/8 x .035	*	*					
1-1/4 x .042		*		*	*	*	
1-1/4 x .045			*	*	*	*	
1-1/2 x .042			*		*	*	
1-1/2 x .050			*		*	*	*
1-1/2 x .055			*		*	*	*
2 x .042				*			
2 x .050				*			*
2 x .055				*			*

**Hook Angle Guide**

Maxx10 (10°): All purpose blade and for mixed hardwoods  
Maxx7 (7°): For mixed hardwoods, seasoned or difficult woods  
Maxx4 (4°): For extreme hardwoods, exotic and frozen woods  
SuperMaxx7: High horsepower, production sawing

**Tooth Spacing Guide**

1/2" (2 TPI): Resawing  
3/4" (1.3 TPI): All purpose  
7/8" (1.1 TPI): All purpose  
1" (1 TPI): High horsepower, high production



**REMOVES DUST AS IT CUTS!**

Available in 3 sizes • 1 x .042 x 3/4 • 1.125 x .035 x 3/4 • 1.25 x .042 x 3/4



Contact Your Current Distributor or  
877.366.1696 • [WoodMaxxBlades.com](http://WoodMaxxBlades.com)

## Heavy Duty Seating for Sawmills, Logging, Construction and More!



- Durable
- Comfortable
- Ergonomic
- Replacement Parts for Long Life & Easy Maintenance

We specialize in the design and manufacture of equipment seats, suspensions, pedestals, armpads and seating related products.



Heavy Duty Seating Specialists for over 40 Years!

**800-346-2839**  
or 503-266-6885  
[www.indseat.com](http://www.indseat.com)  
sales@indseat.com  
Canby, Oregon

**CORINTH PARTS**

We are the source for any and all models of Corinth Sawmill parts. We also stock all your sawmill supply needs: **SIMONDS** saws, sawbits, shanks and knives, Tyrone Berry carriage feeds and parts, Parker Hannifin cylinders, valves and parts, and more.

**NEED FAST SERVICE?  
YOU GOT IT!**

**Corinth Mill Supply**

318 Tate St. P.O. Box 574  
Corinth, Mississippi 38834  
**800-356-3893**  
**(MS) 800-843-8930**

**PALLET CUTSTOCK**

Northern Dense  
Hardwood & Aspen  
Deckboards & Stringers  
Notching Available

We Are Now Offering ISPM15 Compliant  
Heat Treating For Our Lumber

**Also Available** Anti-Mold/Stain  
Treatment

**Sagola Hardwoods, Ltd.**

For the highest quality & best prices,  
contact: Steve Shirkey

Phone: **906-542-7200**  
Fax: **906-542-3524**  
E-mail: [steveshirkey@att.net](mailto:steveshirkey@att.net)



Salem 6' Band Head Rig  
See complete inventory at  
[lps-inc.com](http://lps-inc.com)

**800-598-3651**



**Actual Size  
Handheld  
Super-Size  
Performance**

For Lumber, Logging,  
& Cruising, switch  
to the handheld  
that consistently  
out-performs  
all the others.

For more info and a  
risk-free demo call  
**888.520.1951**  
Or go online at  
[www.eLIMBS.com](http://www.eLIMBS.com)

**eLIMBS**  
ELECTRONIC LUMBER INVENTORY MANAGEMENT BUSINESS SYSTEMS

**Replaceable Tip Hammers & Teeth  
for Montgomery Hogs!**

Ellison Sales has **PROVEN**  
maintenance solutions...

- Perfect Fit
- Durable, Long Lasting
- Cuts Downtime
- Eliminates Shipping Parts  
Back & Forth



**1-888-244-0161**  
[sales@ellisonsales.com](mailto:sales@ellisonsales.com)  
Hog Parts - Screens - Rebuilds



**Third Man Nailer**



Call for  
FREE DVD

**Jig & Stacker**

**Build Pallets Faster  
and For Less Money!**

**RT Pallet Equipment**  
**306-737-3310**  
email: [roberttrembley@hotmail.com](mailto:roberttrembley@hotmail.com)  
[www.rtpalletequip.com](http://www.rtpalletequip.com)



View the video  
on our website.

BOX 29 Imperial SK  
S0G 2J0 Canada

# Thinking Auction?



## Don't Gamble!



Associated Auction is the **ONLY** Company Providing **ZERO RISK OPTIONS!**

### True Guarantee

It's That Simple - We Agree on **GUARANTEED** price and

**Guaranteed in Writing!**

### Cash Sale, No Terms

100% Funded Prior to Auction

**Our Risk...Not Yours!**

### Commission Offset

We Set an Agreed Upon Total Sale Price and

**We Do Not Earn One Cent of Commission Until We Reach It!**

**We are THE Sawmill Experts!**

Licensed • Bonded • Insured

**Proven Results • Years of Experience • Aggressive Marketing Campaigns • Top Dollar**

Associated Auction & Liquidation Company  
[www.associatedauctioncompany.com](http://www.associatedauctioncompany.com)  
[sales@associatedauctioncompany.com](mailto:sales@associatedauctioncompany.com)



Schedule a No Obligation Consultation!

**800-598-3651**

## Genuine HMC Parts

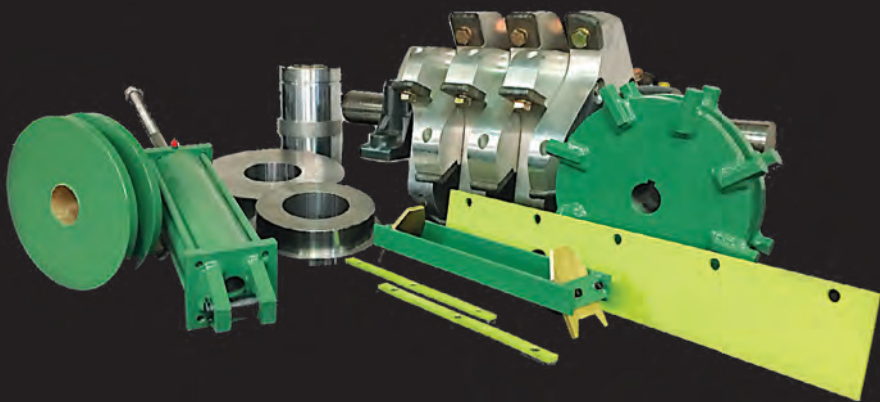

**DISCOUNT COUPONS**  
 for Parts in our Outside Lots K7, 8 & 16 at the Richmond Expo!

**Proudly made in the USA since 1953**  
[www.hmccorp.com](http://www.hmccorp.com)

*When planning for routine maintenance, we're ready to help.*



"The **HMC Customer Service Department** stocks replacement parts for our debarkers, conveyors, carriages, trimmers, resaws, and **MORE!** If you need it, there's a good chance we have it...in stock. Downtime is expensive. Count on HMC to keep you running."

284 Maple Street Contoocook, NH 03229 **Phone: 603-746-3399 • e-mail: parts@hmccorp.com**

Contact our Parts Department directly at:

## Stop Losing 5-20% Of Your Material

**Our Laser Lines Save You Time And Money**

- 5-20% Material Savings
- Reduced Setup Time

**Laser Environments Include**

- Humidity & Temp. Extremes of Portable Saw Mills
- Coolant & Water Exposure of Bridge Saws & Wet Saws
- Harsh Vibration of Vertical Edgers

**Last Up To A Decade**

- 24 Month Warranty
- Serviceable
- 24 Hour Repair Turnaround

**Start Saving ASAP**

- Same-Next Day Shipping
- Easy Installation



**Boost Your Mill's Efficiency  
 The More You Wait  
 The More You Lose**

**CALL NOW for a Quote: 833-608-8488**

**LumberLine Laser**  
 EST. 1985

[sales@lumberlinelaser.com](mailto:sales@lumberlinelaser.com)  
[lumberlinelaser.com](http://lumberlinelaser.com)





Richmond Raceway Complex  
600 Laburnum Ave | Richmond, VA

Register today at [EXPORichmond.com](http://EXPORichmond.com)!

FRIDAY &  
SATURDAY

**20**

MAY 2022

**21**

Virginia  
Tech's Forest  
Products Innovation  
& Technology Summit (\$50)  
will be held at the Hilton Garden Inn  
in Sandston on **Thursday, May 19**.  
Register for the Summit or EXPO at  
**[EXPORichmond.com](http://EXPORichmond.com)**.

**JOIN US FOR THE  
38th EAST COAST  
SAWMILL & LOGGING  
EXPOSITION**

Take in the East Coast's largest array of sawmill,  
pallet, logging, biomass and related machinery,  
supplies and services.

**300+ indoor & outdoor exhibits**

See machinery in action, watch the Log  
Loader Contest, and attend our valuable  
pre-expo workshops.

**One entry fee, 2 days of admission**

Convenient access with plenty of parking  
and food trucks serving all day long.

Visit [ExpoRichmond.com](http://ExpoRichmond.com) to register  
before **April 15** at the **\$10 early rate**.  
After April 16, admission is \$20/person.  
Spouses and children under 18 admitted  
with paying adults.



# WE WILL BUY

**Boards  
42"-48"**

(Any Thickness & Width)

**Runners  
45" 2-way  
52" 4-way  
72" 4-way  
96" 2-way  
120" 2-way**

(1-1/4" - 1-1/2" Thickness)

**Pallet Source Inc.**

**CALL: (404 767-7868)**

**EMAIL:**

**[palletsource2@hotmail.com](mailto:palletsource2@hotmail.com)**

## VIKING DUOMATIC AUTOMATED 3 STRINGER NAILING MACHINE



**Very well cared for  
and maintained. Still  
under power and in  
good working condition.  
Working demonstrations  
are available upon  
request. Can build up  
to 60X60 pallets.**

**Contact: Ben Remmey • 570-658-9900  
Lehighton, PA**



TurboSawmill Automated and Manual Warrior swing blade sawmills are the most innovative portable sawmills by using swing blade technology, a unique open side frame, and patented automation. TurboSawmill will produce accurate, dimensional lumber with every cut.



**SLABBER WARRIOR**  
Automated or Manual Slabber is configured to offer significant advantages to include easy set up, fast running chain speed with angled bar to push easily through a log.

Starting at \$11,000

For TurboSawmill Questions Call Jay at 318-266-8091 | jay@smithsawmillservice.com

# NORTHTECH

Machine, LLC



DUST COLLECTORS



UP CUT SAWS



GANG RIP SAWS

DO YOU NEED TO UPDATE YOUR MILL? WE HAVE IN-STOCK INVENTORY OF NORTHTECH MACHINES. GIVE US A CALL FOR DETAILS.

For NorthTech Questions Call Travis Rector at 936-205-7022 travisr@smithsawmillservice.com



318-266-8091 | sawmill.shop

## Have you considered UPGRADING your machine control? Give us a call for options.

### Proportional Valve Tester PVT-2



### Scanning Carriage Systems



*I wanted to take a minute and thank you for a job well done in getting our new Scanner and set-works up and running after the install. Production improved 15% over our com set-works. Yield has also improved. Please thank your whole team for a job well done.*

Bob Williams - The Ames Companies, Inc.

### Linear Carriage System



### Resaw Systems



See Us At: **EXPO Richmond** May 20-21 Booth 615

*Paw Taw John has user friendly systems and their customer service has been excellent.*

Greentree Forest Products, Inc.



(208) 687-1478 | www.pawtaw.com | 18125 N. Ramsey Rd., Rathdrum, ID 83858

**The Best Fitting  
Sorter Parts  
For Sawmills!**

Need faster service and lower prices for sorter & other parts for your mill? We can help!



Most of our parts are custom made and CNC machined to your specs!

"Send us one of your old parts, we'll build you a better one!"

- Fast turnaround times
- Wear strips cut to spec
- UHMW Channel

Also: J-bars, C-hooks, pusher lugs, diverters, chain lug rollers, chain guides, plus lots more!

**Brooklet Plastics, LLC**  
**Elite CNC Routing & Woodworks, LLC**  
**912-842-5258**  
 e-mail: [bpplastic@frontiernet.net](mailto:bpplastic@frontiernet.net)



Magnum Cheeta  
 4-Stringer Nailer w/Stacker  
 See complete inventory at  
[lps-inc.com](http://lps-inc.com)

**800-598-3651**



**BUYING**

**Red Aromatic Cedar Logs**

By the foot or by the ton all year long!

**Call For New Pricing!**

MILLER'S CEDAR Call Allen . . . Let Ring  
 HORSE CAVE, KENTUCKY **270-786-4316**

**HOG PARTS**

**Did You Know You Can Buy Parts For Montgomery Hogs, Jeffrey Hogs & Other Brands From ONE Source?**

Ellison Sales has a good selection of parts available -- **Replaceable Tip Hammers, Anvils, Screens, Rotor Shaft Assemblies and More** -- and is ready to help...

**Call Dan the Hog Man today...**



**1-888-244-0161**  
 Fax: 503-293-0816  
[www.ellisonsales.com](http://www.ellisonsales.com)  
[sales@ellisonsales.com](mailto:sales@ellisonsales.com)

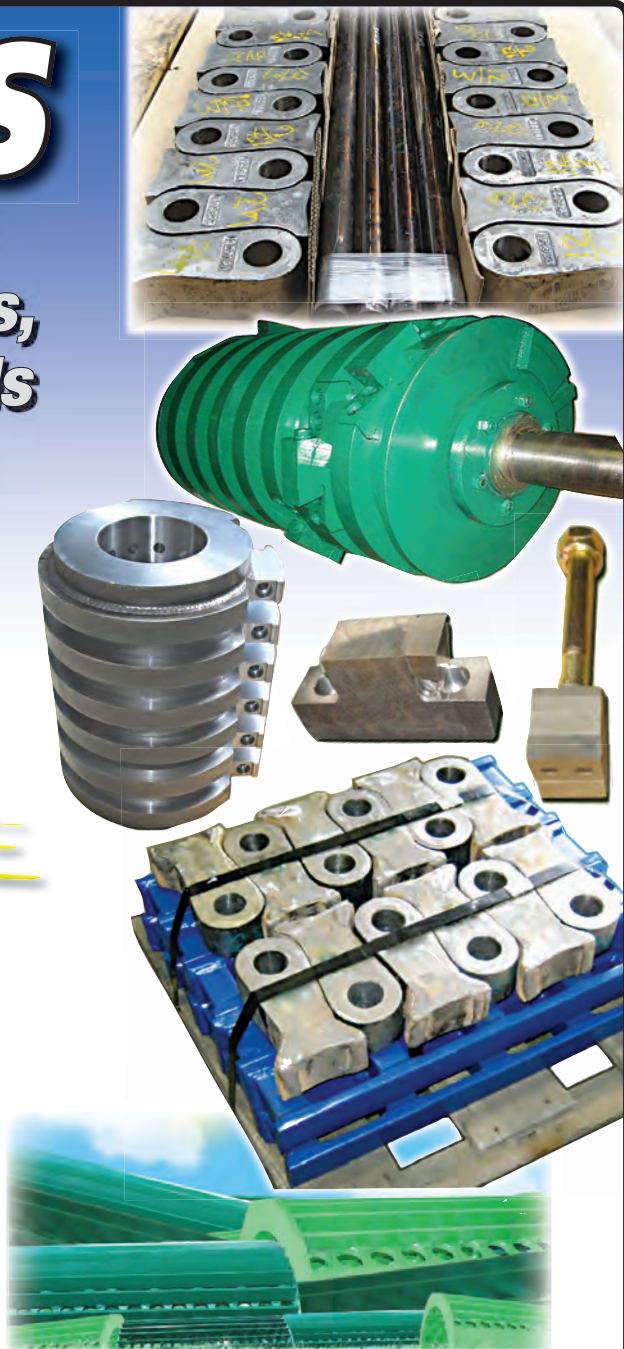
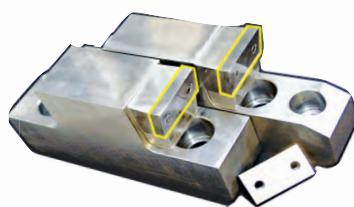
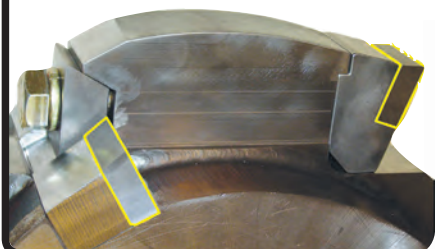

**LITCO** International, Inc.  
*Carry on.*

**866-522-6342**  
[www.Litco.com](http://www.Litco.com)

**LITCO'S Engineered Extruded Wood™ Pallet Blocks**



Choosing Litco's **INCA™** Pallet Blocks is Easy as "**A-B-C**"

- A:** Available and Made in the USA -Eliminates long overseas shipping lead-times
- B:** Benefits Your Bottom Line -Reduce labor, Materials, Waste and Processing Costs
- C:** Consistent Quality, Dimensions and Nail-Withdraw Resistance

# AUCTION!

WEDNESDAY  
MAY 25  
9:00 AM CST

## NELSON HARDWOOD LUMBER CO. PRAIRIE du CHIEN, WI 53821

**Due to the unexpected passing of Kent Nelson, Steve and Brian Nelson have decided to discontinue their successful sawmill and dry kiln operations. They will remain in the log buying and logging operation. This is one of the cleanest, well-maintained sawmill & logging equipment offerings in this area for some time.**

**INSPECTION: The sawmill will be in operation, Tuesday, May 10 – Thursday, May 12 from 8:00 AM – 4:00 PM each day. Interested parties are invited to see the mill in full operation during these times. Inspection of all the equipment will be available Monday, May 23 & Tuesday, May 24 from 8:00 AM - 4:00 PM.**

### REAL ESTATE TO BE OFFERED AT 9:00 AM

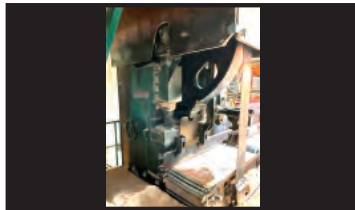

#### **Parcel #1**

Approx. 12+ acres w/ large log storage yard and good, graveled, truck, trailer, loading and driveway areas.

**21,500 Sq. Ft. Mill Building w/ fire suppression sprinkler**

**5,600 +/- Sq. Ft. File Room/Shop**

**1,200 Sq. Ft. Office**

#### **Parcel #2**

##### **Truck Shop**

Approx. 7350 +/- Sq Ft Steel Insulated Building w/ 18 +/- side walls, in floor heat, situated on approx. 3 1/2 acres.

**Closing on parcels #1 and #2 to be on or before July 15, 2022.**

#### **Parcel #3**

##### **Complete Dry Kiln Operation;**

**Located at 27133 Sawmill Rd. Richland Center WI.**

5 – Irvington Moore USNR 50,000 BF Each Dry Kilns. Repaneled & Repaired in 2015 w/ 2006 USNR VFD Controls (In Very Good Condition)

2006 Hurst 300 HP waste wood boiler. Feeder – housed in 40” x 80” steel/concrete building.

Kewanee 200 HP N.G. back up boiler.

3 – Steel Air Drying Buildings; 2 – 36’ x 115’; 1 – 36’ x 96’ w/ concrete floors & enclosed ends.

2 – Lumber Storage Buildings: Steel Clad, wood frame w/ roll-up doors: 1 – 60’ x 290’ & 1 – 60’ x 100’.

60’ x 40’ Drying Stick stacking shed **Planer & Stacking Building**

100’ x 120’ Steel Frame Insulated Building w/ concrete floor, fully insulated.

Situated on 30.47 +/- Acres w/ very nice graveled & fenced yard. There is plenty of room for expansion of buildings.

14 Unit Sawdust/Chip Bin.

#### **EQUIPMENT TO BE OFFERED WITH DRY KILN OPERATION**

Newman EPR – 24 double sided roughing planer.

106” x 42’ 4 strand transfer deck w/ C 55B chain.

Mattison 202 straight-line rip saw.

#### **Froedge Breakdown & Lumber Stacker**

**Closing on parcel #3 will not be before October 1, 2022.**

**REAL ESTATE TERMS:** 10% Buyers Premium. 10% down day of auction. Balance is due at closing. Property is being offered subject to Owner’s confirmation.

Chad Glaze – Broker 715-340-6162.

Visit our Website for Real Estate Bidders Packet at [www.wausauauctioneers.com](http://www.wausauauctioneers.com).

#### **2 – McDonough 6’ Band Mills w/2 Cleereman LP Carriages & Scanners**

##### **LEFT HAND MILL**

Cleereman LP 42 linear position carriage, 14” wheels; 6’3” & 4’4” block spacings, 50’ of 60# rail, s/n

##### **LP42-533.**

Cleereman 30 hp electric/hydraulic power unit.

2019 Cleereman Linear Carriage controls w/3D 8 head scanning optimizer w/ cameras.

Mc Donough Mod 6-7A. LH band mill; air strain; s/n 72MA-438.

Approx. 14 New & Used 6’ LH saw blades.

WEG 200 hp electric motor.

Toshiba Mod TE-361 BP 200 hp starter.

Tyrone Berry Mod SMA 250 C-40’ shot gun feed works w/100hp electric/hydraulic power unit.

50 hp electric/hydraulic power unit. 2019 Cleereman 5’ x 8’ cornerless insulated control booth.

Custom Built heavy duty bar type log turner.

10 hp electric/hydraulic power unit. Mellott 24” x 15’ pneumatic slab drop belt.

Mellott 10” x 20’ 3 strand log infeed deck w/ Tulsa Winch; hydraulic stop & load.

Mellot 30” x 45’ x8” power roll case w/ 6 arm pneumatic kicker.

Mellott 117” x 27’ 4-strand transfer deck, C118 chain.

Mellott 80” x 8” 3 strand transfer deck w/ H78B chain.

##### **RIGHT HAND MILL**

Cleereman LP42 linear position carriage; 14” wheels 6’3” & 4’4” block spacings, 50’ of 60# rail, s/n 42-507.

Cleereman 30 hp electric/hydraulic power unit.

2018 Paw-Taw John All Knee Linear Scan Carriage set works w/ scanner.

Mc Donough 6-7A R.H. band mill; air strain; s/n 72MA-275.

WEG 200 hp electric motor.

Toshiba Mod TE – 361 BP 200 hp Starter.

Tyrone Berry Mod SMA 250C shot gun feed works w/ 100 HP electric/hydraulic power unit.

40 hp electric/hydraulic power unit.

Cleereman 5’ x 8’ cornerless insulated control booth.

Custom Built heavy duty bar type log turner.

10 HP electric/hydraulic power unit.

Mellott 24” x 12’ pneumatic slab drop belt.

Mellott 10’ x 20’ 3 strand log infeed deck hydraulic stop & load.

Mellott 117” x 13’ 4 strand transfer deck, C118 chain; stops.

Mellott 30” x 48’ x 8” power roll case w/ 5 arm pneumatic kicker.

##### **PRECISION DEBARKER**

Precision P636 slant track Rosserhead debarker, 50hp on head.

11’ x 48’ 3 strand log infeed deck w/ 4 arm hydraulic stop.

Patz 17” x 128’ barn sweep bark conveyor w/ 32’ steel chute (Clockwise).

**Auction Is Being Conducted In Conjunction With Associated Auction & Liquidation, Co.**  
**Visit Our Websites at: [www.wausauauctioneers.com](http://www.wausauauctioneers.com) or [www.associatedauctioncompany.com](http://www.associatedauctioncompany.com)**



Chuck Lepinski  
800-598-3651

**Wausau Auctioneers**  
WAUSAU SALES CORP

#### **AUCTIONEER:**

Carl Theorin, – Registered Wisconsin Auctioneer #135.  
Registered Wisconsin Auction #26.



# AUCTION!

## NELSON HARDWOOD LUMBER CO. CONT'D

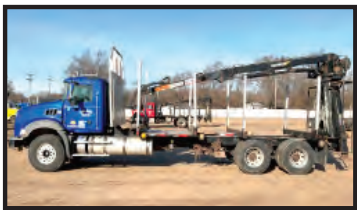

55' WD110 chain log trough outfeed conveyer w/ 2 way 4 arm pneumatic log kickers & 1 way 3 arm pneumatic log kicker.  
15 HP & 10 hp electric/hydraulic power unit.

### **CROSBY EDGERS & REMAN EQUIPMENT**

Crosby 36" board edger w/ 40 hp electric.  
Crosby 20' tailing belt.  
Crosby Size 32 Reman edger w/ 30 hp motor.  
Baker A single head horizontal band resaw w/ 32' feed thru belt conveyer.  
Alden Multi Rip Saw w/ 60 hp motor & blower.  
2 Arm Breakdown hoist (Not Installed).

### **SAW TRIMMER; GRADING DECK; GREEN CHAIN; TRANSFER DECK; TIE SORTER**

Newman Whitney KNO-24 Automatic Selection Overhead Trimmer; 4' - 16'; 8 saw.  
Mellott 117" x 87' 3 strand green chain.  
Mellott 10' x 32' 4 strand grading deck w/ 30" pop up roller (to feed tie sorter).  
Mellott 24" x 52' 2 sort tie sorter.  
Mellott 10' x 21' 4 strand transfer deck.  
Mellott 10' x 60' 4 strand transfer deck; H78A rooftop chain w/ 11' 4 strand drop transfer deck.  
36 - steel lumber stacking carts.

### **CHIPPER & WASTE WOOD HANDLING**

Precision 66" chipper.  
250 hp electric motor.  
Toshiba TE2 series solid state 250 hp starter.  
Precision PCS-77 7' x7' chip screen.  
Precision cyclone.  
Phelps 48" van loading blower w/ 25 hp motor; 2 Y pipes & diverters; many feet of new pipe.  
Approx. 24" x 100' elevated belt conveyer w/ hopper (for van loading).  
Precision 22" x 26' vibratory conveyer.  
MDI CR 85 metal detector w/ 4' fiberglass vibratory section; s/n M4-0416.  
6 - Mellott 20" belt conveyors from 29'-65' long.

Patz 16" barn sweep conveyor w/ approx. 360' of chain; 40' steel chute; (counter clockwise).

### **AIR COMPRESSORS**

3 - Gardner Denver Electra Screw 30hp rotary screw air compressors w/ air reservoir, From 7K-81K hours.  
Pneumatech Mod EH-250 regenerative air dryer.

### **ELECTRICAL**

Westinghouse Motor Control Center.  
Westinghouse 1000 amp 480 volt Switchboard.  
Square D 600 VAC 400 amp. 350' hp disconnect.  
Plus large amount of assorted disconnects, starters, wire & conduit.

### **FILE ROOM & SHOP EQUIPMENT**

Armstrong automatic electronic leveler.  
Armstrong #4 LH & RH band saw sharpeners w/ stands & clamp.  
Armstrong #5 stretcher roll  
Armstrong #12 welding clamp.  
Armstrong bench w/ anvil.  
Hanchett Size 136 circle saw grinder.  
Michigan 48 chipper knife grinder.  
Precision 6K 40 tub knife grinder.  
Plus welders; Milling machine; Radial arm drill; Band saw & Tools.

### **BOILER & WALNUT STEAMER**

1999 Hurst "Cyclone" 40 hp N.G.; Approx. 10K was spent on the boiler in 2021.  
2- kiln doors w/ truck; rack & frame.  
Heat Exchangers.

### **PARTS AND ACCESSORIES**

Sawmill; Debarker; Chipper; Loader; Truck & Trailer Parts.  
Electrical; Hydraulics & Pneumatic Parts  
Hardware: Nuts, Bolts, Fasteners.  
Large Selection of Steel Cat Walk & Stairs.

### **WHEEL LOADERS, SKID LOADER, FORKLIFTS**

2018 John Deere 624 K-II wheel loader; cab w/ A.C.; JRB Style Q.C.; 6450 hours.  
2006 John Deere 544 J wheel loader; Cab w/ A.C.; JRB Style Q.C.; 15,673 hours.  
John Deere 3yd, JRB style QC bucket.  
2018 B&D 6 yd. JRB Style Q.C. bucket.  
Fleco JRB Style Q.C 54" loader

forks.  
B&D JRB Style Q.C. forks w/ log clamp.

GEM JRB Style Q.C. 4' forks.  
Set of 18,000 lb. JRB Style Q.C. forks.

2-11' Hydra Turn Snowplows w/ JRB Style Q.C.

1984 Caterpillar 930 wheel loader; cab w/ heat; pin on bucket & forks.  
1994 Volvo L70B wheel loader; cab; Q.C.; 23,608 hours.  
Q.C. 3 yd. Bucket.

Q.C. Log forks w/ clamp; 5' forks.  
Mustang 940 E skid loader w/ forks & bucket; 2982 hours.

Taylor TYB-180M "Big Red" forklift, cab; 14.00 x 24 front tires, 8' forks; side shift, 6448 hours showing.

### **LOG SKIDDERS**

2000 John Deere 540 G III cable skidder; cab; 10,050 hours showing.  
1991 John Deere 540E cable skidder; cab; 11,725 hours showing.  
2 - 1978 & 1979 Caterpillar 518 cable skidders; 141 & 2935 hours showing.  
Caterpillar 508 cable skidder; 1,031 hours showing.  
Several Pair of 23.1 x 26 skidder chains.

### **DOZER**

1997 Caterpillar D5M XL crawler dozer; Cab; Allied Winch; approx. 7,500 hours.

### **LOG LOADER TRUCKS & PUP TRAILERS**

2 - 2017 Mack GU 813 tandem axle log trucks; Mack MP8 445 C engines; Maxi Torque ES 10 speed; aluminum wheels; 20,000 front axle; 66,000 rears; air ride cabs; spring suspensions; 2016 Roto Bec Elite 910 knuckle boom loaders; 22' steel log racks w/ aluminum headache racks & aluminum stakes; 164 K & 235 Miles.

2002 Mack CL 713 Maxi Cruise tandem axle log truck; Mack E7 427HP engine; Eaton Fuller 8 LL; aluminum wheels, air ride cab; spring suspension; Roto Bec Elite MT 26 knuckle boom loader; 22' steel log rack w/ aluminum headache rack & aluminum stakes; 123 K miles.  
1997 IHC PayStar 5000 SFA 6x6

Pre Hauler truck; Cummins M-11 Plus engine; Eaton Fuller 10 sp; 550/60 - 22.5 rear float tires; Roto Bec Elite Charge Use knuckle boom loader; 21' steel log rack; approx. 200K miles.  
3 - 2015, 1999, 1991 2 axle 18' log pup trailers.

### **TRUCK TRACTORS**

2004 Mack CX 613 Vision tandem axle sleeper cab truck tractor, 65" sleeper, Mack 427 engine; Eaton Fuller 10 sp; aluminum wheels; air ride; 489K miles.  
2003 IHC 9100 tandem axle day cab truck tractor; Cat C-12 425 hp engine; Eaton Fuller 10 sp; aluminum wheels; air ride; 12,000 front axles; 40,000 rear axles; 365K miles.

### **DUMP & WATER TRUCKS**

1989 Mack Econodyne RD 690 S Quad axle dump truck, Mack EM6-300L 300 hp engine; Maxitorque T 2070 7 sp Ext. Range trans; 2 steerable lift axles; 18' steel dump body; 446K miles.  
1986 International Mod F9370 Eagle tandem axle dump truck; Cat 3406 400 hp engine; Eaton Fuller 15 sp. deep reduction trans; Northern 22' steel dump box w/ 6' sides w/ hydraulic end gate; 732K miles.  
1986 Mack RD 685S tandem axle dump truck; Mack 300 HP engine; Maxitorque 7 sp.

### **TRAILERS**

1999 & 1996 Benson 48' x 96" aluminum 10' spread axle flatbed trailers, air ride; bunks and detachable stakes.  
1991 Reinke 48' x 96" aluminum tandem axle flatbed trailer.

### **6 CHEVROLET 1500 SILVERADO 4X4 PICKUP TRUCKS**

Crew, Ext., Reg cab; From 128K Mi. - 228K Mi.

### **MANY ATTACHMENTS & SPECIAL & MISC. ITEMS**

### **10,000 GALLON DOUBLE WALL FUEL TANK**

B & H Flameshield FS001345 10,000 gallon double wall fuel tank w/ Petro Vend 100 OPW fuel control system.

### **SPECIAL ITEMS**

### **AUCTIONEER:**

Carl Theorin, - Registered Wisconsin Auctioneer #135.  
Registered Wisconsin Auction #26.

**Auction Is Being Conducted In Conjunction With Associated Auction & Liquidation, Co.**

**Visit Our Websites at: [www.wausauauctioneers.com](http://www.wausauauctioneers.com) or [www.associatedauctioncompany.com](http://www.associatedauctioncompany.com)**

**INTERNET BIDDING:** If you are unable to attend this auction in person, simultaneous internet bidding is available via Proxibid.

A 13% Buyer's Premium per lot will be added to internet purchases.

**REGISTER AND BID FOR THIS EVENT AT WAUSAUAUCTIONEERS.COM**

**ONSITE BUYERS:** A 10% Buyers Premium per lot will be added to the purchase price.

**TERMS:** Payment can be made by cash, cashier's check, wire transfer. Personal or Company checks with a current bank letter. Any other arrangements must be made with Wausau Sales Corp. prior to sale date. All items are sold "As Is Where Is" without warranty or guarantee of any kind.



**Wausau Auctioneers**  
WAUSAU SALES CORP

**PIPER'S  
SAW SHOP**

(800)845-6075 • Request a Free Catalog • [www.pipersaw.com](http://www.pipersaw.com)

**LENOX**

**Wood-Mizer Blades**

**SIMONDS RED STREAK®**  
Narrow Kerf Bandsaw Blades

**Mighty Giant Tub Grinders Turn Pallets,  
Wood Waste and Lots More Into \$\$\$!**

Mighty  
GIANT

See Us At:  
**EXPO**  
 Richmond  
 May 20-21  
 Outside Lot G 16

**Jones Manufacturing Co.**

" Since 1929 "

[www.mightygiant.com](http://www.mightygiant.com) • 402-528-3861

KMC Double Arbor Gangsaw with Sizer

- 6" x 12" CUTTING CAPACITY
- OUTBOARD ARBOR BEARINGS
- TOP POWERED COLEMAN HOLD DOWN ROLLS
- ONBOARD SIZER ADJUSTABLE FROM 1" TO 6"
- POWERED SHARPTOP CHAIN HOLD OVER
- NICKEL HARDENED PADDLE TRACK ON INFEED AND OUTFEED WEB WITH AUTOMATIC GREASER

---

- 12" BLADE CAPACITY ON BOTTOM ARBOR
- POSITIVE HOLD DOWN DRIVE ON 26" LONG MATERIAL

---

OPTIONAL

- DIESEL POWER UNIT OR ELECTRIC MOTOR DRIVE
- 4 OR 6 WING INDEXABLE CUTTERS

**Keystone Machinery**  
CORPORATION

20 Cocalico Creek Rd. Phone: (717) 859-4977  
 Ephrata, PA 17522 Fax: (717) 859-4979  
[www.keystonemachinery.com](http://www.keystonemachinery.com)

# GOOD USED EQUIPMENT FOR SALE



**West Plains 18"x60' Rollcase w/3-arm Board Kicker w/Drive. Used only 7 months.**



**Morbark 36" Dual Trailer Loading System w/40 HP Motor. Used only 7 months.**



**10 Dry Kilns**

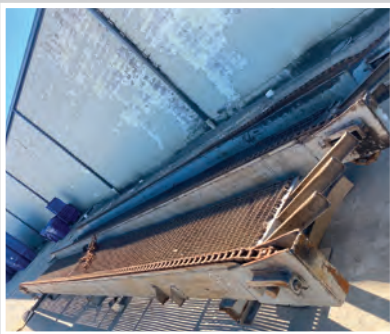

**(3) Log Decks w/Stop and Loader**



**Digital Truck Scale 120,000 lbs.**



**Acme 150 KVA Transformer**



**40 Ton Crane Grapple**

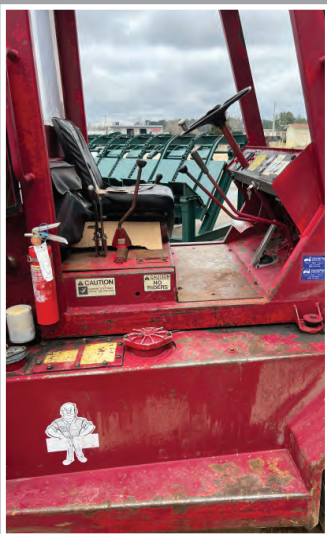

**Taylor Forklifts**



**Cooper Scragg Line w/ Saw Box Vibrator, Stacker**



**Wood-Mizer LX 25 mill, 20' long. Like New!**



**Linden Log Step Feeder**



**20' Breakdown Hoist. Complete System!**

## ALSO AVAILABLE:

- (6) MORGAN END TRIMMERS
- BAG HOUSES
- WASTE CONVEYORS
- KILN CARTS
- CHIP BINS



**Jim: 706-590-3624  
Hunter: 706-590-4200**

**abneyco@ymail.com · www.AbneyCo.com**

**TRIM FASTER WITH GO FAST!  
SINGLE HEAD  
TS10 TRIMSAW**

**CHOOSE YOUR SIZE SAW BLADE**



**"SAFE, SIMPLE, & FAST"**

- 4 STRAND CHAIN INFEED
- CHOOSE 5HP OR 10HP MOTOR
- QUICK-ADJUST BOARD STOPS
- LARGE RULER FOR SETTING STOPS
- OPTIONAL VFD FOR VARIABLE CHAIN SPEED
- CONFIGURE WITH 10", 12", OR 14" BLADE SIZE
- UP TO 4" TALL CUT CAPACITY (WITH 14" SAW BLADE)



**DOUBLE HEAD  
DET-20 TRIMSAW**

**CHOOSE YOUR LENGTH CAPACITY**



- 4" TALL CUT CAPACITY
- VARIABLE INFEED SPEED
- 5HP OR 10HP MOTOR OPTIONS
- 20" CARBIDE TIPPED SAW BLADES
- EASY TO READ RULER FOR ADJUSTING LENGTH OF CUT
- OPTIONAL FLAT AND RISER WASTE CONVEYORS AVAILABLE



**MULTI-HEAD  
MET-20 TRIMSAW**

**CHOOSE YOUR NUMBER OF BLADES**



**"A HEAVY-DUTY TRIMSAW"**

- 10HP BLADE MOTORS
- 4-1/2" TALL CUT CAPACITY
- 20" CARBIDE TIPPED SAW BLADES
- VARIABLE INFEED SPEED—STANDARD
- QUICK-ADJUST LENGTH SETUP W/ RULER
- EQUIPPED WITH EMERGENCY PULL CABLE
- EACH SAW IS CONFIGURED PER CUSTOMER ORDER



**GIVE US A CALL TODAY. OUR TEAM IS READY TO ASSIST YOU WITH YOUR PALLET AND SAWMILL EQUIPMENT NEEDS.**

**1-800-854-7439**

**WWW.GOFASTMFG.COM**

**FLEX-FINANCE AVAILABLE**



**SAVE THE DATE**

**August 23-25,  
2023**

**NOW**

**IS THE TIME**

**FOR NASHVILLE**

Bringing the sawmill industry together for more than 70 years.

**Music City Center  
Nashville, Tennessee**

**Request information today:  
mail@SFPA.org**



SFPA is proud to produce, organize and sponsor the Forest Products Machinery Equipment Expo



## B-5 FEED COMPLETE WHEEL FITS MORBARK PS8

IMPROVES THE FEED, AND OUTLASTS THE CONE TYPE SPIKES BY AT LEAST 7X- 10X, WHILE IMPROVING THE FEEDING PERFORMANCE.

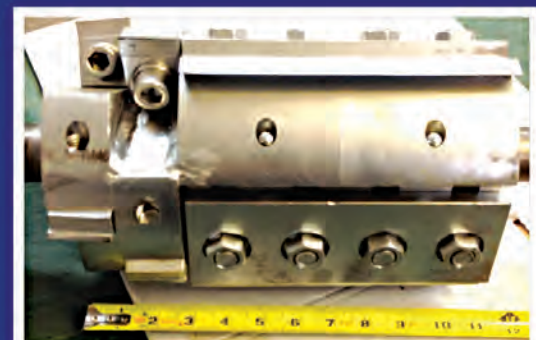

8" KNIFE HEAD



SQUARE KNOTTER & ANGLE

WE CARRY MANY OTHER POST & POLE PARTS.

CALL TODAY FOR A LIST OF PRODUCTS.

## ATS SPIKES

Featuring a weld-lock design & created from a solid, high-quality chrome alloy, ATS Spikes are American-Made & easy to install.

We have many different shapes & sizes to choose from. Custom sizes are available upon request!

### OPTIONS

#### #1) Long Life Spikes or Tips

Made from a tough, durable alloy, outlasting common products by at least 7 times.

#2) Tungsten Carbide Sprayed Spikes or Tips  
Only second to the ATS Long Life Spikes, these last much longer than the machined ones.

#### #3) Heat Treated Spikes or Tips

Machined spikes, when it is not necessary for either #1 or #2.

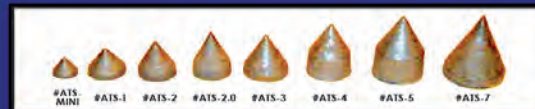

LARRY SCHMEDDING SR.  
CELL: 509.994.4700

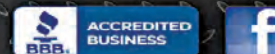

PO BOX 612  
GREENACRES, WA 99016  
LNSCHMED@GMAIL.COM

SEND PHOTOS OF OLD PARTS YOU NEED REPLACED FOR EASY IDENTIFICATION!

## West Plains Grade Resaw Systems are Built to Run & Built to Last!

See Us At:  
**EXPO**  
Richmond  
May 20-21 in the  
Old Dominion Building

There is nothing more frustrating than constant breakdowns and lost production from machinery being built too light and with low quality parts. We have the solutions.

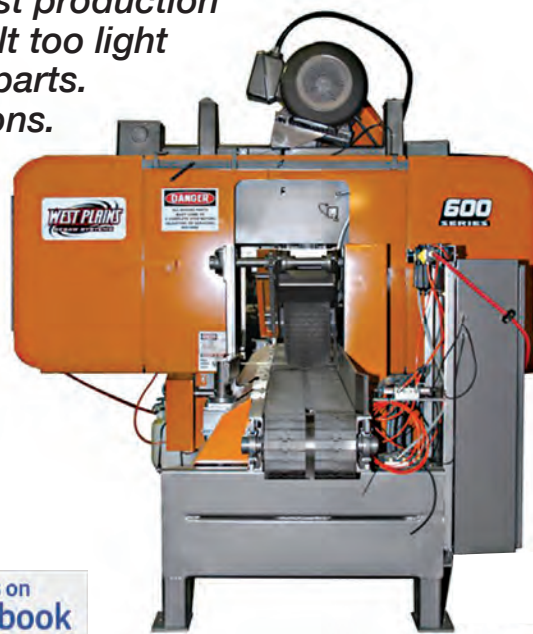

**We Also Offer:**

- Pallet Bandsaws — Single & Multi-Head
- Chopsaws — Single & Multi-Head Trimsaws, Mini Edgers,
- Whole Tree Cut-Up, Package Decks, Unscramblers,
- Log Decks, Green Chains, Belt & Roll Conveyors.

**ALL of our Resaw Systems...**

- Come completely wired and tested — ready to install!
- Feature Hydraulic Setworks and Full Return Systems



**200 Series**  
Economical Grade Resaw to make your thin kerf, specialty mill or lower production circle mill more profitable. Standard cap. 16" x 16"

**400/500 Series**  
The "Next Step" in production and profit. The perfect fit in medium & high production mills. Standard cap. 18" x 18"

**600 Series**  
The "Ultimate" in production and profit. With the 6" band & 75 HP head motor you can easily cut grade lumber at 150 fpm and higher. Standard cap. 18" x 18". Optional — 20" x 20"



Call us today  
**417-256-4885**

www.westplainsresaw.com  
E-mail: westplainsresaw@gmail.com

# COMPLETE HARDWOOD SAWMILL OPERATION ENTIRETY SALE - LOCATED IN MISSOURI

REAL ESTATE : 40+/- ACRES 1200+/- SQ.FT LIVING QUARTERS WITH AIR CONDITIONED TRUCK SHOP.  
MILL BUILDING WITH BASEMENT AREA. FULLY CONCRETE WASTE CONTAINMENT AREA.  
ENTIRE YARD HAS AN EXCELLENT ROCK BASE.



Pioneer 2 HD Modular Mill w/ Top Saw and Computerized Controls



Late Model Precision 58" Chip Pac



(2) CAT Wheel Loaders

**STILL IN PRODUCTION  
WITH WORKFORCE  
IN PLACE!**

**Call Chuck: 612-390-1844**



HMC 206 Debarker



West Plains 500 Resaw System



Pacific Trail Package Saw



Baker Tie Sorting Stacker Sys



Cornell 848 Combination Edger



Truck Shop and Living Quarters



**LPS** EQUIPMENT & ACQUISITION CO.  
731-986-4351 | sales@lps-inc.com

**Call 800-598-3651  
WWW.LPS-INC.COM**

# Pallet Assembly Solutions from Mona Tracy...

## Thinking About Buying A Nailing System? Universal Gives You Choices...

### New Universal In-Line Nailing System!

#### Serious Stringer Pallet Production Is Now Available...

- Produces 1,200 pallets per day
- Eliminates use of hydraulic fluid for operation
- Up to standard size 64"x 84" pallet as its basic design (other size options available)
- Less air controls • Two or three man operation
- Fully automatic stacker • PLC controlled, no pneumatic switches

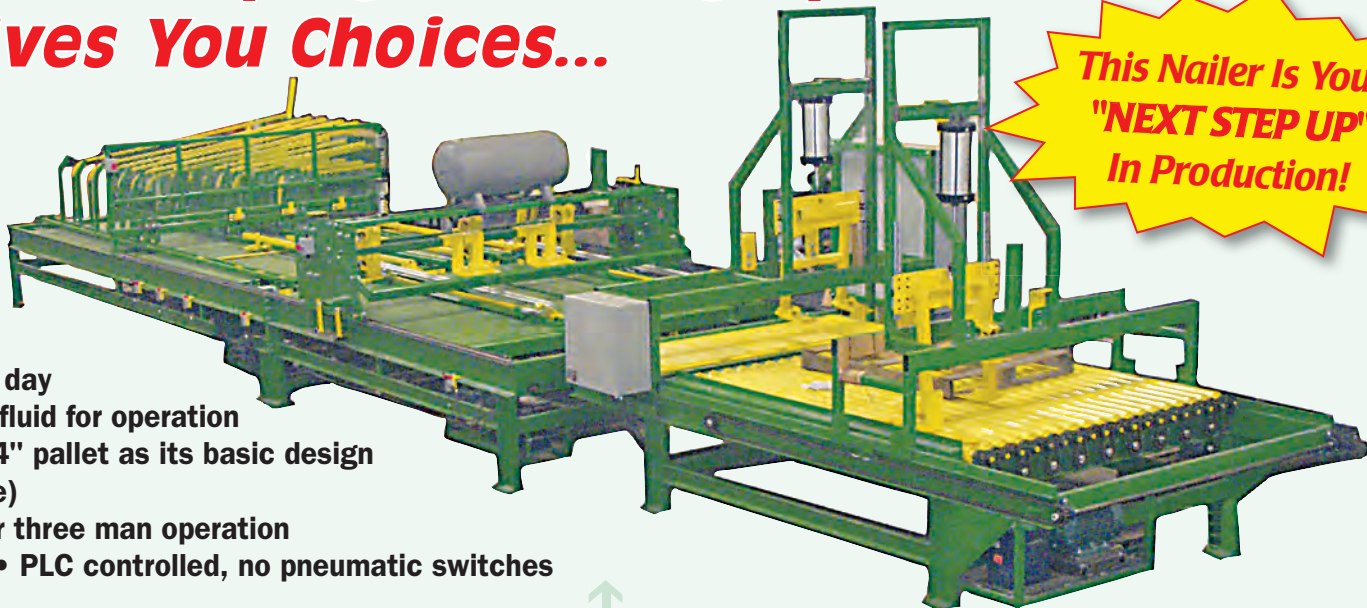

**This Nailer Is Your  
"NEXT STEP UP"  
In Production!**

*Exclusively designed  
for Universal Machinery  
by JSB Industrial Solutions, Inc.*



### NAIL-MATE II Flat Table/Manual Handling

- For standard and larger size pallets

### The "REVO" Revolving Work Station

- For New Pallets, Recycling or Reman jobs



**Block Pallet  
Attachment  
Available!**



- Assembles all size pallets (up to 50" x 50") with easy adjustments
- For New & Recycled lumber

### The "NAIL EASE"

**Fast, Easy  
Assembly  
of Any Size  
Pallets!**



### NAIL-MATE Automatic Nailing Jig

- 12 years proven in the industry
- Auto firing, one-man operation
- Handles 3 or 4-stringer pallets, wing pallets or others up to 56" x 50" at a rate of 1-2 pallets per minute!



### The Nailing Station

- Hold down system and swivel turn over for nailing both sides

### JAM DOCTOR

- Clears Nail Jams!



**UNIVERSAL**  
MACHINERY SALES, INC.

Sales: Mona Tracy  
Universal Machinery Sales, Inc.  
**Toll Free 1-855-298-8890**  
e-mail: sales.universalmachinerysales@gmail.com  
www.universalmachinerysales.net

**Leasing  
& Financing  
Available**

# DUST COLLECTION - PALLET SHOPS



**We Design**  
**We Install**  
**We Recycle Fiber**

See Us At:  
 **EXPO**  
Richmond  
May 20-21  
Booth 731



**BOULWARE EQUIPMENT, LLC**

**3134 Pinkie Lane, Newton, NC 28658**

**PH: (704) 651-6061 • [brad@boulwarellc.com](mailto:brad@boulwarellc.com)**



# HOT ON THE MARKET!

**New Product?**  
List It Here —  
Solve Your  
Advertising  
Puzzle!

## The Rivet Beast



**Henniker Saw** is proud to introduce “The Rivet Beast.” The all in one tool for replacing ITCO saw teeth! The Rivet Beast does not operate with power tools of any sort. The only tool required for both rivet removal and insertion is a socket wrench. (A 3/8” Allen socket will be provided.) It allows the user to remove and replace teeth in the field for quick and easy repairs! No more awkward blocks with the bolts constantly wearing out. This is the tool you need!

For More Information,  
contact: 800-752-0627  
www.paynesaws.com

SCAN TO  
WATCH VIDEO



## The Industry Standard for Trimming Excellence!



**KM-16  
Multiple Trimmers  
from Newman Machine are  
the "Go-to" choice for precision, high speed trimming.**

Quickly trim your lumber into multiple lengths  
at high production levels!

Low Maintenance ■ Fast, Easy Setup ■ Quick Change Saw Arbors

Backed by our standard warranty  
and supported by our second-to-none parts & service department.

**NEWMAN**  
QUALITY WOODWORKING MACHINERY  
SINCE 1907

Newman Machine Company, Inc.

**336-273-8261**

www.newmanwhitney.com  
sales@newmanwhitney.com

MASS drop-in replacement for  
SILVATECH and THOMAS INDUSTRIAL networks.  
Your choice of Touch Screen or Hardwired Pushbuttons.  
If you have ever thought about upgrading,  
now is the time!

Setup					
Bottom	Clear	6.1/2	11.11/64	Mem1	Mem2
		10.0/64	11.11/64	0	0
4.1/8	9.1/8	.....	AUTO A1	4.1/8	1
			11.11/64		
3.1/8	8.1/8		6.1/8	3.1/8	8.1/8
2.1/8	7.1/8		1.1/8	2.1/8	7.1/8
1.1/4	6.1/8		1.1/8	1.1/4	SetQ
1.1/8	5.1/8		1.1/8	1.1/4	6.1/8
Shim	Fill	Save	Stack	Clear	1.1/8
					5.1/8

✓ Modular Networks for New Installs

✓ Replacement System Upgrades for Set Shaft & Linear Positioning Carriages, Line Bar & Horizontal Resaws and Carriage Scanning Systems.

● Hundreds of systems in operation

● Direct replacement for obsolete and outdated network systems



See Us At:  
EXPO May 20-21  
Richmond Booth 714

pk@massinc.net  
www.massinc.net  
205-267-5220



Custom-engineered tooling since 1970



# PROFILE TECHNOLOGY

RETHINK • RETOOL • RELAUNCH



See Us At:  
 **EXPO**  
 Richmond  
 May 20-21  
 Booth 106

WE CUSTOM-DESIGN, MANUFACTURE, AND DELIVER CUTTING TOOLS AROUND YOUR EXISTING EQUIPMENT

 1-1/2" RADIUS NOTCHING HEAD	 HIGH SPEED BRAZED SURFACING HEAD	 INSERT CORNER ROUNDNER HEAD	 EDGER BLADE HOGGER SAW	 1/2" RADIUS INDEXABLE NOTCHING HEAD
 CANT SIZER PLANNER HEAD	 CARBIDE INSERTS & SAW TIPS	 INDEXABLE DADO BAND NOTCHING HEAD	 NAILBUSTER® TRIM/CHOP SAWS	 INDEXABLE CHAMFER CUTTER

Contact us today for an optimal tooling solution to increase your output and improve machining efficiency



**NAILBUSTER TOOLING**  
CUTTING WOOD WITH NAILS  
CUTTER HEADS • SAW BLADES  
INDEXABLE INSERTS  
SINCE 1984



STROBE SAWS  
RIP SAWS  
NAIL CUTTING



GANG SAWS  
EDGER SAWS  
CUTOFF SAWS

800.369.4242 **PROFILETECH.COM** info@profiletech.com



## Attention Northeastern Pallet Manufacturers: We're Your Logical Choice for Precut Material — for over 25 years!

- HARDWOOD & ASPEN
- CHAMFERING AND NOTCHING AVAILABLE
- VERSATILE PRODUCTION FROM BOTH SCRAGG MILLS AND REMANS

TEL: 418-872-7171 FAX: 418-872-6622 e-mail: sales@precutwood.com  
 Website: www.precutwood.com



INTERNATIONAL C.L. INC

## The Morgan Line-Up!



**Original Single Head Resaw**



**4-Head Resaw**



**Wide Cut Resaw**



**Multi-Head Trim Saw**



**Military Band Notcher**



**Board Duster**

 **UNIVERSAL**  
 MACHINERY SALES, INC.

Call Mona Tracy

**855-298-8890**  
 or **812-298-8090**

sales.universalmachinerysales@gmail.com

WoodLandia

# LogRipper®-2000X/XP

10-30 Linear ft of Milled Logs Per Minute

Dimensional Lumber,  
4-sided Cants,  
Pallet Boards  
in One Pass

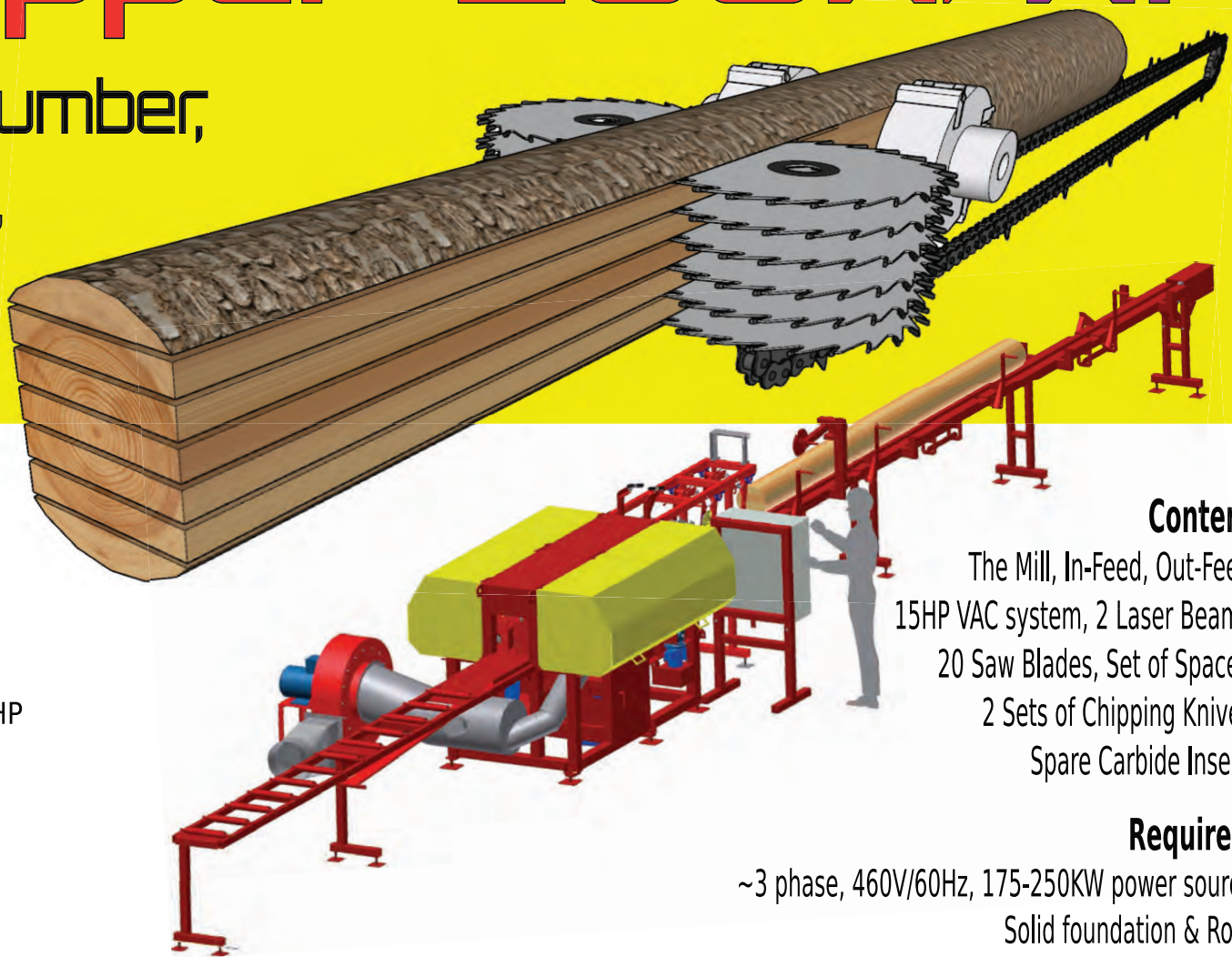

### Features

- Compact Complete Sawmill for Logs between 3 and 11",
- Min Log Length: 40", Max: 21ft
- The Distance between Cutters can be changed from Log to Log
- Chipping Motors: 2x30HP or 2x40HP  
Rip-Sawing Motors: 2x24HP
- Output:  
Min Board Thickness: 3/8"  
Board Width Range: 2 3/8" - 6 1/4"

### Content

The Mill, In-Feed, Out-Feed,  
15HP VAC system, 2 Laser Beams,  
20 Saw Blades, Set of Spacers  
2 Sets of Chipping Knives,  
Spare Carbide Inserts

### Requires:

~3 phase, 460V/60Hz, 175-250KW power source,  
Solid foundation & Roof,  
2-3 men team to operate



## It Can Do It!

Find LogRipper  
Demo Vids on 



For further info & videos, please, visit our website:  
[www.woodlandia.ca](http://www.woodlandia.ca) or call: 1-877-508-8777



Also we offer: LogRipper-300 (for bigger logs), LogMolders, LogRounders, Log Lathes,

# CHOICES & OPTIONS

SAWMILLS

EDGERS

MATERIAL HANDLING

PORTABLE  
DIESEL  
BLUE STREAK  
3674DD



STATIONARY  
ELECTRIC  
BP DOMINATOR  
3650E



PORTABLE  
3638G  
BAND MILL



STATIONARY  
ELECTRIC  
BOARD EDGER



PORTABLE  
BOARD  
EDGER



## BAKER Products

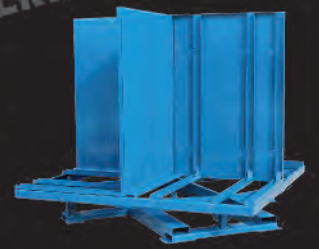

**LOWER LABOR**  
WITH MATERIAL HANDLING

[www.Baker-Online.com](http://www.Baker-Online.com)



573.663.7711

800.548.6914

See us at the Richmond Expo booth #G-23,24 & 25