



www.amlumber.com
August 2015

American Lumber & Pallet

Sawmills • Pallet Mills • Woodworking • Logging 1-800-992-3432

Loaded with Pages and Pages of New & Used Equipment and More!

In This Issue:

Auctions

Associated Auction & Liquidation Co.:

August 22nd • Worcester, NY
Page 47

August 26th • Silver Plume, CO
Page 48

August 29th • Newland, NC
Page 49

Tri-State Auction & Realty LLC:

August 15th • Ewing, KY
Page 52

August 22nd • Oakland, MS
Page 53

August 29th • Nashville, TN
Page 54

James G. Murphy Co.:

September 23rd • Grangeville, ID
Page 58

Shows

Kentucky Wood Expo:

September 18-19th • Lexington, KY
Page 56

The Paul Bunyan Show:

October 2-4th • Cambridge, OH
Page 59

Great Lakes Logging & Equipment Expo:

September 10-12th • Escanaba, MI
Page 61

See Our **NEW** Website —
www.amlumber.com!

Pallet Assembly and Recycling Solutions from Mona Tracy...



NAIL-MATE Automatic Nailing Jig

- Auto firing, one-man operation
- Handles 3 or 4-stringer pallets, wing pallets or others up to 50" by 50" at a rate of 1-2 pallets per minute!

Over 14 Years of
Proven Nailing Experience!

ONE OPERATOR
can make
300+ Pallets
per day!

The "NAIL EASE" Jig



- Assembles all size pallets (up to 50" x 50") with easy adjustments
- For New & Recycled lumber

"If you're going to produce one or two sizes, the Nail-Ease is a great machine to boost production over what an operator can do with a nail gun alone."
— Dominick Davi, president of Greenway Products & Services, LLC

Pallet Recycling's Heavyweight Champion...



The RUN-A-GADE Bandsaw Pallet Disassembly System

- "The Tank" handles even heavy-duty pallets
- The take away conveyor saves the cost of one operator
- Your savings in blade cost alone pays for the machine!

UNIVERSAL
MACHINERY SALES, INC.

Call Mona Tracy

Toll Free 1-855-298-8890
or 812-298-8090



Money-making machines
for any size operation!

www.universalmachineriesales.net

E-Mail: sales.universalmachineriesales@gmail.com
Leasing & Financing Available

PRESORTED
STANDARD
U.S. Postage Paid
Atlanta, GA
Permit No. 3592

AMERICAN LUMBER & PALLET
P.O. BOX 1136
FAVETTEVILLE, TN 37334



YOU ASKED FOR IT!

INTRODUCING A NEW WAY TO EDGE YOUR PALLET BOARDS TO DECREASE WASTE & INCREASE YIELD.

The Baker Pallet Board Edger is a simple system that upgrades #2 material into #1 pallet boards. Two small circular saws re-rip boards to remove waney edges or to re-size the width of your material. This Baker Pallet Board Edger adds value to your #2 boards and decreases waste at the same time.

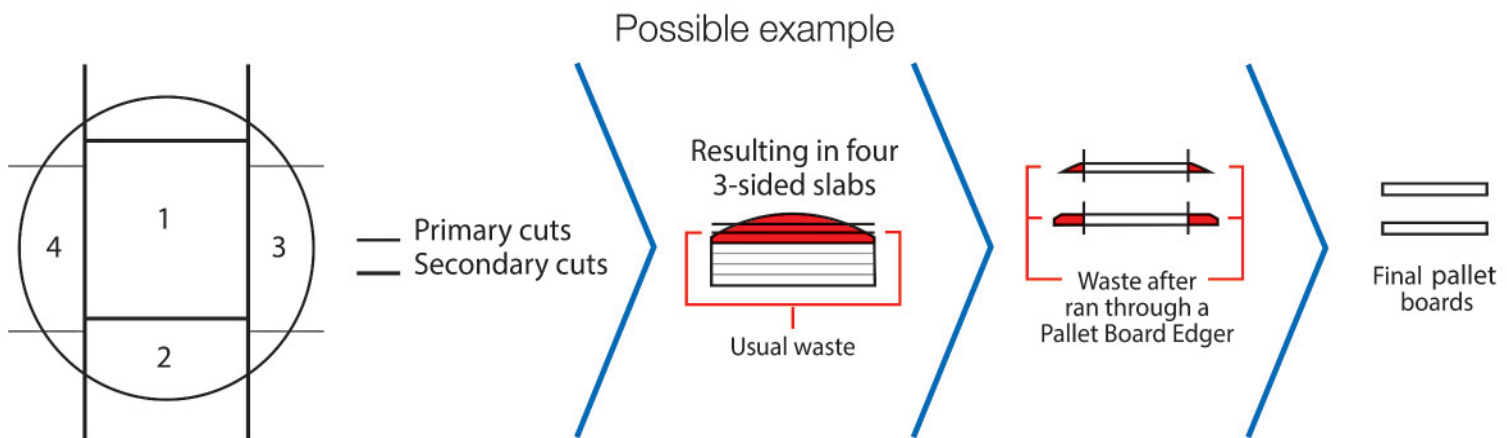

CALL A SALES REP TO LEARN MORE TODAY!

573.663.7711 / 800.548.6914

www.bakerproducts.net info@bakerproducts.net Like us on 

TO MAKE EVERY DOLLAR COUNT— YOU HAVE TO MAKE EVERY CUT COUNT



Selecut® V with **Inline Squeeze**

- For prime lumber cut to length or Precision End Trimming needs, our Selecut®-V uses a Fixed Frame Assembly with a moveable cutting platform to meet your production needs in a limited space environment and is available with our Inline Power-Squeeze Package Alignment system.
- For high-volume automated crosscutting of industrial length stock, our Autocut®-V uses a computerized carriage assembly with PLC controls enabling you to process lumber without an operator present.

Transcut® II Station
from **\$26,999***



Transcut® II Portable
from **\$7,999***



Autocut® V

- For custom manufacturers, our Transcut® II Station will cleanly cut through a unit of hardwood or softwood in less than a minute using generic chain-saw chain and with a precision of +/- 1/16th" or better*.
- For simple crosscutting of EWP or lumber, our versatile Transcut® Portable saws are priced and designed to offer a significantly safer and faster alternative to hand-held chain saws.

We're proud of the fact that HOLTEC pioneered the concept of precise package cutting over 40 years ago. Today our industry's technological and manufacturing advances have enabled us to achieve the fastest cut in the industry and an unmatched precision on every cut. So, if you're considering investing in a package-crosscut saw, consider these facts*:

- At 55 seconds per cut HOLTEC systems cut up to twice as fast as other systems available today;
- With our own team of dedicated Field Technicians and service vehicles, HOLTEC is the only company that provides you a service response time of 24 hours or less on-site and on-time;
- Our state of the art Germany manufacturing facilities are ISO-9001 certified, ensuring that you're getting the highest quality manufacturing standards available today;
- With an unmatched precision of +/- 1mm (.040"), HOLTEC systems exceed precision-end-trim tolerances;
- HOLTEC systems are designed with the highest safety standards in the world, ensuring that your employees are working in the safest environment for package-crosscutting available today;
- HOLTEC has almost 2,000 systems in North America and over 8,000 systems delivered worldwide, ensuring that we'll be here for you in the future as we have been for the last 40 years

WE ENSURE EVERY DOLLAR COUNTS BY ENSURING EVERY CUT COUNTS

HOLTEC®
PRECISION CROSSCUT SYSTEMS

www.holtecusa.com

**Holtec [USA] Corporation, 2802 Sydney Road, Plant City, Florida 33566 • [813] 754-1665 • Fax [813] 752-8042
TOLL FREE 1-800-346-5832 • eMail: info@holtecusa.com**

*All specifications are subject to change without notice. Pricing is FOB Tampa, Florida and subject to change without notice. Photographs may show systems with optional accessories. On-site service may not be available in certain remote locations. Proper maintenance procedures are essential for accuracy and longevity, and accuracy results are based on HOLTEC installed systems using Scratcher® chain technology. Stroke speed may vary based on specie and dimension of lumber. HOLTEC, TRANSCUT, SELECUT, AUTOCUT & MAXIMUS are registered trademarks of HOLTEC GmbH. All other trademarks are the property of their respective owners. Warranty and guarantee terms are subject to limitations and delivery or installation to certain remote locations may incur additional charges. ©2015 HOLTEC (U.S.A.) Corporation

Check With Us Before You Buy. Find Out What Thousands of our Repeat Customers Already Know...

We Have the Industry's BEST Reputation for Used Sawmill and Planing Mill Equipment!



Acrowood 6120
Slant Disc Chipper



Black Clawson
48 in. Chipper



Hazeldine
Chamfer Machine



Industrial Resources
Pallet Dismantler



Precision
66 in. Chipper



Clarke
24 in. Rotary Hog



HewSaw Chipping
Canter & Gang



Morbark 640
Debarker



McDonough
54 in. Resaw



WSM 2432
Hammer Hog



Morgan
Shifting Edger

This is only a small selection from our HUGE inventory.
Visit our website –
www.machinerysales.com
– or call us for help with your next project.



Weinig
Profimat Moulder



20-Unit
Peerless Bin



Michigan 45"
Knife Grinder



Precision P-636-H
Debarker



Mid-Oregon
Lateral Feed Table



Morbark
48 in. Chip Pac



503-285-6691

Fax 503-285-0449

9802 North
Vancouver Way
Portland, OR
97217

Over 10 acres of machinery In Stock!

Call (Toll Free) **1-866-241-2977**

For a complete equipment listing, go to

www.machinerysales.com

e-mail: machsales@msn.com

Unleash the Awesome Power of the Verticut P4!

Now with inline
(One step Cut in Two)

SQUEEZE

Learn more about L-M Equipment on **YouTube**
Search: **LM Corporate Video**



Precision. Performance. Production. Profit.

Perfect for Rig Mat & Truss Stock, L-M's Verticut P4 consistently delivers a P.E.T. cutting tolerance of $\pm 1/32"$ and a trim end finish that is as good or better than conventional trim saws.

Built to Provide Service, NOT Require It



The Verticut P4 is one great machine in the L-M family of efficient, cost effective package lumber cutters. With 60 years in the business, L-M Equipment has more package cross cut systems in operation than any other manufacturer in North America. We serve customers around the world.

Contact L-M Equipment for more information!

Features include:

- Programmable touch screen
- Automated PLC controls
- Remote starting
- Operator weather protection
- FACT™—Fast Advance Cutting Technology to substantially reduce cutting cycle time.



L-M Equipment Company Ltd.
604-576-0088 • Fax: 604-576-0089
Toll Free 1-800-455-8807
Email: sales@LMSaws.com
www.LMSaws.com



Portable Yard Saw



I-CUT



PalMate[®] ERP

defining efficiency

Revolutionizing Recycling & Timber Operations





- Simplified inventory management
- Paperless BOL processing
- Streamlined production & delivery scheduling
- Track piece rates & productivity
- Forklift mounted tablet PCs and Bluetooth scanners



www.PalMateERP.com

Automated Machine Systems, Inc. | 877-267-8384





American Lumber & Pallet

Sawmills, Pallet Mills, Woodworking, Logging

Published Monthly By:
ASKINS PUBLISHING GROUP, INC.
P.O. Box 1136
Fayetteville, TN 37334

PUBLISHER/EDITOR
Bill Askins
bill@amlumber.com

ADVERTISING SALES
Shawn Askins
shawn@amlumber.com
1-800-727-9684
Randy Tallman
randy@amlumber.com
1-800-992-3432

CIRCULATION DEPT.
circulation@amlumber.com

GRAPHIC DESIGN DEPT.
Jeff Moyers
jeff@amlumber.com
Barbara Locker
bop@amlumber.com

PHONE: (931) 433-1010
TOLL FREE:
800-992-3432
Anywhere in the U.S.A. & Canada

FAX: 931-433-1081

E-MAIL alp@amlumber.com
www.amlumber.com

Subscriptions (Presorted Standard Mail)
Free to Sawmills, Pallet Operations, Woodworkers, Veneer & Chip Mills and Loggers with portable sawmills in the U.S. Other businesses or individuals in the U.S. \$25.00 per year.

Subscriptions (First Class Mail)
U.S.A and CANADA - \$50.00 per year. Other foreign subscriptions call for prices.



Any advertising copy submitted for publication is deemed the property of the advertiser, and is used on the condition that all liability for copyright laws is the sole responsibility of the advertiser.

©August, 1990

BIOLUBE Lube Master Spray System for Cool, Resin Free Saws.

Lube Master is the most economical, reliable, easy to operate, maintenance free lubricating system on the market. With BIOLUBE lubricants, this system will keep saw blades and woodworking tooling cool and clean.





- Keeps all saws, bands and tooling cool and resin free
- Accurate and economical to operate
- Simple to install, operate and adjust
- Rugged for an industrial or mill environment
- All pneumatic, no electrical components
- Large 5 gallon reservoir
- Supported by a nationwide distributor network
- Everything included; brackets, nozzles, tubing, air pressure regulator, filter and gage
- Adaptable for all machinery; head saws, resaws, gang rips, package saws and moulders

Biolube Inc.
PO Box 9732 Fort Wayne, IN 46899
260-414-9633 or 260-467-9208
Web: www.biolube1.com Email: sales@biolube1.com

Complete Sawmill Liquidation Yankee-Equipment.com

Many other items available as well including conveyors, boilers, notchers, resaws, transfers, tilt hoists, stackers, along with many other sawmill and pallet equipment!



6' McDonough "High Strain" Band Mill



7'x14' BM&M Chip Screen with Ball Deck



8'x25' Heil Drum Dryer



8'x60" Ukiah TA Thin Kerf Gang (2)



27" Nicholson A5B Ring Debarker



40" Opening Goring Kerr Whole Log Metal Detector (2)



60" CM&E/Schurman Model 600SS Chipper



100HP Quincy Q490 Air Compressor



American Wood Dryers Kiln



Baker 3 Head Resaw — Nice!



Bob Hanna Notcher



Complete Filing Room



Cornell 2 Saw Precision Trimmer



Two (2) Kewanee Boilers 650HP



Viking 3 Head Resaw



Yates American Planer Model A-15H BoardMaster (late model)

Contact: Mike Knapp
Office: 208-839-2665
Cell: 503-709-8378
e-mail: michaelknapp@frontier.com
www.yankee-equipment.com

You need sensors that work reliably in areas with...



Pantron Sensors

- Blast through steam, sawdust, & fog
- Not affected by vibration or sunlight
- Through-beam range up to 230 feet
- Eliminates need for compressed air

Perfect for Sawmills!



Call toll-free or visit us on the web
1-800-211-9468
pantron.com





ROTOCHOPPER
Inc.
Made in The USA

"Perfect In One Pass"®

**HIGH-VOLUME
WOOD GRINDING
SIMPLIFIED**

The proof is in the product

The Rotochopper FP-66 takes high-volume wood recycling to a new level, outperforming bigger grinders while minimizing fuel costs and maintenance downtime. Best of all, the FP-66 offers the same precision grinding built into every Rotochopper, so you get better mulch, fuel, or bedding, at a lower cost per ton or cubic yard.

How can the FP-66 maximize the value of your wood waste? Contact us to learn more.

Follow Rotochopper on      

320-548-3586 www.rotochopper.com

Short Studs & Pallet Cutstock

KD HT HF/DF/SPF 1x4, 1x6, 2x4, 2x6
Any length Cutstock. Flatbed delivery from our New Plymouth, Idaho manufacturing plant.
Also: Green 1x4, 1x6 MRR

Call 1-800-447-3792
e-mail: tjforest@gmail.com

**The Original
Lake States "Premier"
Industrial Hardwood
Lumber Producer**



**Pallet operations
have relied on us for
High Quality Lumber
for over 40 Years!**
.... 1/2 "thru 8/4"
pulled to length
Lumber, Timbers & Cants
*If you want a good product to process
in your plant and not have to deal
with lots of waste...*

Call us today!
989-348-5412
www.ajdforestproducts.com
info@ajdforestproducts.com
Four Mile Rd. • Grayling, MI 49738

BANDSAW WHEELS

- New & Used From 20" to 108" Dia. Steel Wheels.
- For All Makes And Models of Bandmills Including Replacements For Cast Wheels.
- Portable Bandmill Wheels and Components.



Premier Bandwheel & Equipment Ltd.
Phone: (604) 591-2080
Fax: (604) 591-2835

www.premierbandwheel.com
E-Mail: sales@premierbandwheel.com

**Precut Pallet Stock
Hardwood & Aspen**

Lumber Resources delivers throughout North America

Call Philippe or Gilles Martel @ **1-866-815-0404** (toll free)
Or e-mail: pleblanc@rlumber.ca
418-624-0038
fax: 418-624-1008
www.rlumber.ca
"Your Lumber Store!"



FOR SALE

**1994 Model
Pendu 4300
Gang Saw**
\$88,000

with Pendu 4400 Stacker w/Scrambler,
Pendu 2400 Chop Saw
and 10' Infeed Table w/Unscrambler
Whole set, excellent condition, will consider offers.

330-866-1008 Ext. 2



SMART PRODUCTS

Is Your Answer! For Pallet Lumber Recovery and Repair Solutions.

"The Difference is Engineering"

Leasing & Financing Alternatives Available

Dismantlers

One-Man Dismantler



- 52" or 64" capacity
- 10 HP, 3-phase, electric motor standard (2200 FPM blade speed) (single phase available)
- Optional 15 HP, 3-phase (4400 FPM blade speed) electric motor available
- 18 HP gas-powered electric start on Portable Dismantler
- Gear reduction drive
- Self-contained hydraulic blade tensioning
- Low maintenance durable blade guide bearings
- Push button operated table height adjustment

Two-Man Dismantler



Pallet Dismantler System

- 64" capacity **Front Discharge** Dismantler
- Linear accumulating conveyor feeds boards easily to operator of Inclined Power Trim Saw
- Add additional dismantlers for higher production

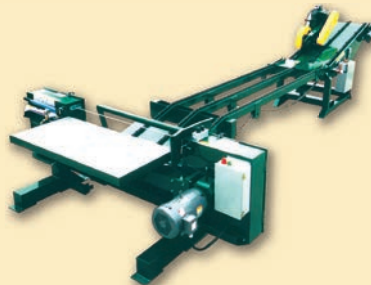

Portable Dismantler



Notchers

Double Head Notcher

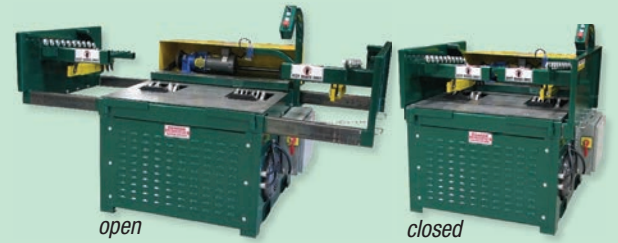

- Two, 20 HP, three (3) phase, electric motors with V-belt driven indexable notching cutterheads
- One-person operation/1,000 double notched stringers per hour
- Notches new or recycled lumber
- 48" to 96" stringer capacity standard
- 9" x 1-1/2" notches, with 18" between notches
- Quick set-up
- Continuous power feed system
- Self exhaust design (useful when notching recycled material)

Single Head Notcher

- 20 HP, three (3) phase, electric motors with V-belt driven indexable notching cutterhead
- One-man operation/500 double notched stringers per hour
- Notches new or recycled lumber
- 72" stringer capacity standard
- Quick set-up
- Continuous power feed system
- Self exhaust design (useful when notching recycled material)



Pallet Prep



- Commonly referred to as the "SmartSaw"
- Smart Saw is **multifunctional**: designed for repair (1 person) or recycling (2 person) operations of BLOCK or GMA/STRINGER pallets
- Standard 10 HP, 3-phase, electric motor with gear reduction drive
- 20' standard **M42 bi-metal** band saw blade
- Air actuated, 3-position, roller table and table extension easily positions pallet for board removal
- Machine provided with **advanced safety measures** in place, including interlock switches for perimeter guarding and cabinet doors
- Improved **canopy guarding**, with front and rear portions that move up and down with the roller table

- Specifically designed to QUICKLY (as a **1-person** operation) cut out damaged boards, including **top and bottom** deck boards, as well as **connector** and **stringer** boards
- Also designed, as a **2-person** operation, to process the disassembly / tear-down of block or stringer pallets for **INCREASED LUMBER RECOVERY**. For block style machine, includes a specially designed **Block Recovery Tool** (or BRT) that **salvages blocks** now being scrapped with other machines and processes

Double End Power Feed Trim Saw



Trim Saws

- Power Feed Trim Saws trim boards 2" thick from 18" - 60" in length on the single end, and 18" - 66" in length on the double end
- Inclined board feed and overhead saw design help eliminate board kickback
- Manual Trim Saw handles boards up to 6" thick and 6" wide
- 18" diameter nail resistant saw blades and 10 HP motors
- Heavy duty steel tube construction
- Multiple adjustable board stops on Single End and on Manual Feed Trim Saws
- Easy blade change
- Easily moved with built-in fork lift pockets
- Right saw head on double end easily adjusts to cut desired board length

Single End Power Feed Trim Saw

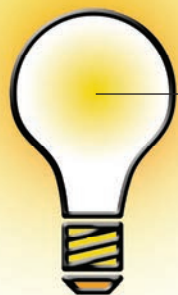

SMART PRODUCTS

3401 North Commerce Drive • Muncie, IN 47303
 Ph: 765.284.9545 • Fax: 765.284.7270
 website: www.smartproductsinc.com
 email: smartpro@smartproductsinc.com

800.401.0099

Every machine we build is backed by the pallet industry's most trusted and respected reputation. You can count on us being here long after the others are gone.

DTS03 DUAL TOOTH SETTER

First introduced in 1996, retooled in 2003, and still **THE MOST ACCURATE** Dual Tooth Setter on the market. Guaranteed.

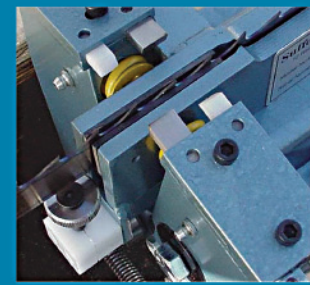

- Equipped with Cobalt up-setting tool bits.
- Sets teeth to within .002 per side.
- Sets from 1" to 2" wide blades.
- Sets from 1/2" to 1-1/4" pitch.
- Hand held Clamp-On Set Gauge included.
- Capable of both increasing and decreasing tooth set.
- Equipped with both Delrin plastic and mild steel down-setting tool bits.
- 3 Blade Stanchion Rollers included.



DTS03
Dual Tooth Setter

Call 800-234-7297
timberwolfbandmillblades.com



**Pallet Mold & Mildew
Causing Problems?**

**Eliminate It Affordably...
Without Chemicals!**

See how at
www.aftstrailers.com
or call
262-677-9033

Cleaner Pallets,
Happier Customers.



Frick Mill For Sale

Frick O1 15' 4 Block Hand Mill
w/ husk, track n ways,
10' mandrel w/ 6" collar

Call: **717-382-1334**

Email:
sales@montgomeryequipment.com

**Mixed Hardwood
Pallet Cutstock**

- 1/2" - 1" Thickness
- 3 1/2" - 5 3/4" Width
- 30" to 60" Length

Pine
Also
Available

**** Stringer Orders Wanted ****

Call Todd or Lisa: **931-296-1455**
trichardson@waverlywood.com

Waverly Wood • Waverly, TN

CLEEREMAN SAWMILL MACHINERY

Why has CLEEREMAN Sold 1050 Carriages?

**The Answer is Simple...
QUALITY & SERVICE!**



**CLEEREMAN
Not just Carriages!**

- CARRIAGE DRIVES
Hydrostatic & Electric
- BAR TYPE LOG TURNERS
2500 - 3500 lbs.
- AIRBAG & HYDRAULIC CABLE
TENSIONERS
- SAWYERS CABS & CONTROL
CABS
- CUSTOM MATERIAL
HANDLING SYSTEMS



12 MODELS

**A CARRIAGE TO FIT
YOUR OPERATION!**

**COMPLETE GRADE & TIE MILL
PACKAGES**



**LUMBER
PRO**

Patent Pending

**Heavy Duty Double Cut Band Mill
That is Sweeping the Industry.**

- 54" or the New 62"
- Reduces Manpower
- Adds Flexibility from 4/4 - 12/4 Lumber,
Beams, Cants, Cross Ties or
EVEN as a Resaw!
- Lower Initial Installation Cost
- Unmatched Accuracy

**All Machines are Cleereman Quality Throughout.
You Get the Best Machines Backed by the Top Service
in the Industry - Call Cleereman Today!**

INFO@CLEEREMAN.COM
WWW.CLEEREMAN.COM

PHONE: 715-674-2700

FAX: 715-674-7002

5500 PINE ST., NEWALD, WI. 54511



**PACIFIC TRAIL
MANUFACTURING INC.**
A difference that will keep you cutting!
888-910-SAWS

Making
quality bars
here
since 1991

NEW BARS

WE
REPAIR

ALL
MOUNTS

SLASHER
BARS

DOUBLE
END

Hand
made from
500bhn
alloy steel.

Harder
than hell
but will
not break!



w
w
w
·
p
t
m
i
·
n
e
t

i
n
f
o
@
p
t
m
i
·
n
e
t

All your 3/4" pitch needs.
Direct from us, the
manufacturer!

Bulk Box & Crate Care

*Our reinforcing corners & plates
are the answer for added*

• Protection • Durability • Strength

- For New or Used items
- Apply by nail gun or hand
- 8 Sizes available
- Tough 20-gauge galvanized
steel

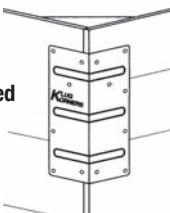

KLUG KORNER

**800-471-5060 or
269-657-6858**

www.klugkorners.com

Heat Treat Stamps



Branding Irons
and Hot Stamps

Propane or Electric

ISPM 15 Compliant

also Available For Nailers



BrandNew Industries, Inc.

(800) 964-8251

BrandNew.net

Live Floor Trailers

From Pickup Truck Beds to 53'

BUY • SELL

RENT • NEW & USED

Full Repair Service & Parts for
Keith & Halco Wet Kits, Hyd.
Pumps, Valves, Hoses & More.

**If You're Thinking
LIVE FLOOR —
THINK FERGUSON FARMS!**

800-326-4919

Fax 574-453-3900 Cell 574-453-7120

We Now Handle Western Belt Trailers!

MULTI-HEAD END TRIMSAWS BUILT BY THE MORGAN FAMILY

PROCESSES BOARDS OR CANTS WITH PRECISION ACCURACY AT TOP PRODUCTION!

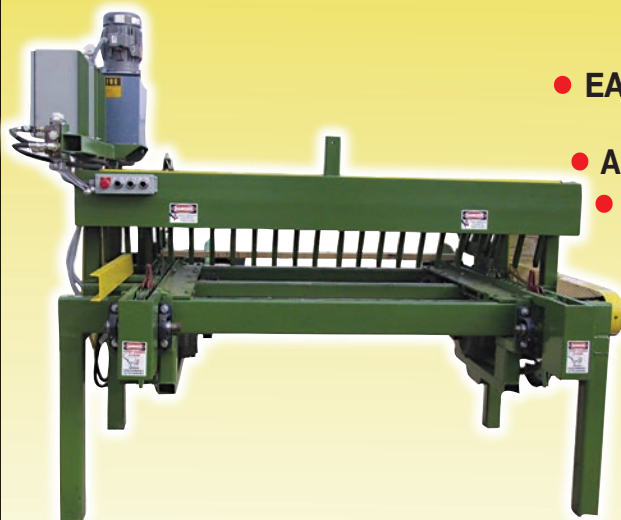

- AVAILABLE IN 2, 3, 4, & 5 HEAD MODELS
- EACH ONE EQUIPPED WITH 20" CARBIDE BLADES AND A 10 HP MOTOR PER HEAD
- ADJUSTABLE HEADS WITH VARIABLE FEED SPEED
- SPRING LOADED ADJUSTABLE HOLD DOWNS
- 5 HP HYDRAULIC UNIT POWERS CHAINS

» **OPTIONAL EQUIPMENT INCLUDES** «
LARGER BLADES (22") AND MOTOR (20 HP)
PLUS PRODUCT AND WASTE CONVEYORS



A family owned business. Builders of the ORIGINAL Low Profile Band Resaw.
Need parts for your Morgan Saw? We've got 'em!

Sawmill Supplies & Equipment LLC
Sarepta, LA
318-994-2116
e-mail: sawmillsupplies@centurylink.net
www.sawmillsupplies.net

Sales Office:
Mona Tracy
Universal Machinery Sales, Inc.
1-855-298-8890
e-mail: info@universalmachinerysales.net
www.universalmachinerysales.net

BANDSAW BLADES

We have the most popular sizes in stock & ready to ship from major manufacturers, including...

LENOX  **Wood-Mizer Blades**
Your Leader in Blade Technology.

Welded to your lengths!

We also offer expert Sharpening Services, plus...

Gang • Edger • Scragg
Trim • Split • Strob

...and just about any Custom Saws you need to keep you cutting longer...for less!

Call Marvin Miller for a quote

231-924-5953 (fax) 231-924-6166

In Stock —
READY
To Ship

Ask About
FREE
Shipping!

MIDWEST
SHARPENING SERVICE

EFFICIENTLY REMOVE BY-PRODUCT WITH PENDU BLOWERS & BARK CONVEYORS

BLOWERS

- 4 and 6 blade fan designs
- Quality steel components
- 18", 26", and 42" models
- Alloy steel shafts, heavy-duty ball bearings
- Quiet operation



BARK CONVEYORS

- Easily move secondary products: bark, sawdust, shavings, etc.
- Straight line or any combination of degree angles
- Can be elevated up to 35° for material depositing into trucks, hoppers, or piles



Stackers Trim Saws Gang Saws Scragg Mills Edgers
800.233.0471 717.354.4348 www.Pendu.com

SIMONDS[®]
KILGORE SAW COMPANY

Thin Kerf Band Saw Blades

✓ *Check Out Our . . .*
 Quality
 Service
 Dependability
 Price

See why we are your **best source for bandsaw blades!**

Satisfaction Always Guaranteed

 Toll Free 

1-888-857-5153
 E-Mail: kilgoresaw@prodigy.net

Parts & Repairs For Your Nailing Machines...

Pallet, Wooden Box, Cable Reel & Tackless Nailers
 Specializing in FMC, Doig
 — even older Morgan & Gage machines!

F.W. Morse / PVI Co. • 518-747-2017
 www.nailingmachineparts.com
 e-mail: morgangageparts@gmail.com

See Us At The Kentucky Wood Expo!
 Lexington, KY September 18 & 19

\$57.73 ROLL OR LESS

We didn't forget about steel!
 #1 Grade A Standard Duty Painted/Waxed Steel Strapping
49¢ lb
 Savings straight from the mill!



Shipping from ♥ of USA.

800-362-9332

Call Henry, Verna, Susan, Sandra, Sarah, Amy, Jennifer, or Emily Today!

    &  Check by Fax or Phone

McGREGOR PACKAGING

Tifton, Georgia
 P.O. Box 7552, Tifton, GA 31793

Try our tool risk free for 30 days!

NEW Tech[®] PCN-55M



TECH

The better alternative for pallet recyclers
More power, less weight & better durability.

For driving nails 1-3/4" to 2" with diameters .083" to .090", we proudly introduce the new Tech PCN-55M nailer.

After many years of experience working with pallet recyclers, we've designed our new tool with features like a thicker reinforced nose and contact arm for extra durability, and air flow that is optimized to generate more power with less weight - a third to a half a pound lighter than competitive tools.

Our customers also report that the new PCN-55M holds up better in colder winter temperatures.

Although nail pricing is one component when choosing a company, an even greater consideration for us is the nail guns. Being a recycler, wood density varies from softwood to rock hardwood. The Tech 55M handled all materials with ease. It has increased production by approximately 30%. A single individual was able to increase his output from 200 to 300 pallets per day, very impressive. Overall its proven itself as a money maker for the company.

- Steven Streeter: Enpac Pallets & Crates Inc.

METROPOLITAN STAPLE CORP.
 www.metrostaple.com
 info@metrostaple.com
 800-255-7209

Turn Your Surplus Equipment Into CASH

We pay top dollar for good used equipment.

Go to our website for an up-to-date listing or call us at **800-241-8983**

 **Ben Jones Machinery**
 Div. of Dickert Enterprises, Inc.
 Industry's Most Trusted Source

UPDATED DAILY!
 www.benjones.com
 E-Mail: sales@benjones.com

Cut Your Blade Costs – Keep Your Profits!



The Pallet Hawg Bandsaw Dismantler will pay for itself in no time in blade savings alone!

- One or Two Man Operation or Pallet Prep Saw
- The most versatile Pallet Dismantler Available
- Gear Reduction Drive for Long Blade Life
- Pneumatic Table Travels 5 1/4" to Allow for Easy Stringer, Block, or Deckboard Removal

NEW Power Feed Trim Saw

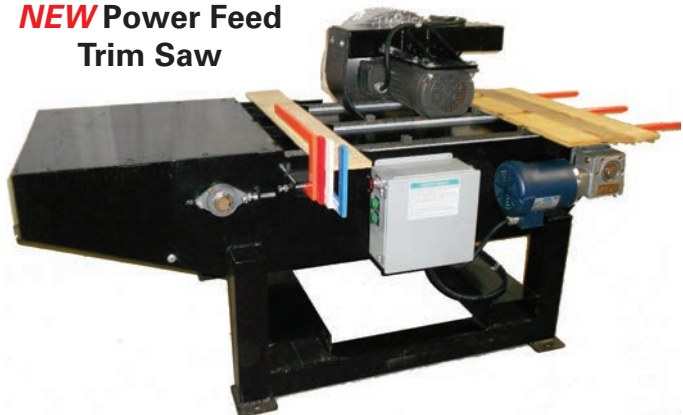

- Up to 12,000 trimmed boards per 8-hour shift!
- 4 adjustable board stops, set from 16" to 66" long
- No belts or pulleys to wear out or replace
- Handles stringer & deck boards up to 2 1/2" thick

NEW Pallet Hawg Up-cut Saw



- Trims both new & recycled lumber
- 10 HP, 18" blade
- 5" x 6" capacity

Change is good.

Get more blade life AND a smoother, more efficient operation.

Call Brad or Kent @
1-800-348-0703

www.noblemachine.com

NOBLE MACHINERY CO. INC.



Your Cut Stock Source

www.SomersLumber.com
(704) 539-4751



Now offering
Common Carrier Services

- SYP Cut Stock
- Panel Cut Stock/CNC
- Band Groove

Owner Retiring

Location: Eastern PA

*This opportunity will be available only a short time because this well-operating business is **Priced to Sell!***

Employees in place.

Owner transition available.

Very diversified and many options to choose from.

To make this fit perfectly for you,



Call

Jacqueline Kittrell

931-698-3342

www.kittrellsawmillbrokers.com

FOR SALE or TRADE

Salsco 30" Shaving Mill

w/30"x 8'6" Log Box, Blower,
3 sets of knives & 100 HP
Cat Diesel Power Unit.

Can be converted
to Elevator!

Great Machine!

931-636-8453

Ramp Up Your Firewood Business!



Model 2040xp2 – The Premier High Volume Firewood Processor

Start or Expand your Firewood Business



Model 1610EZ - Joystick control, gas or diesel, live deck or log lift, ultra mobile with integrated conveyor.

The Log Buster!



- Quarter Oversize Logs for further processing...**
- 115 HP engine
 - Over 100 tons of brute splitting force.
 - Chip, Grind, Pulp, Firewood, Biomass & More!



Prentice, WI 54556-0170 USA • 800-243-5438 • e-mail: sales@multitekinc.com • www.multitekinc.com

DEBARKER TEETH

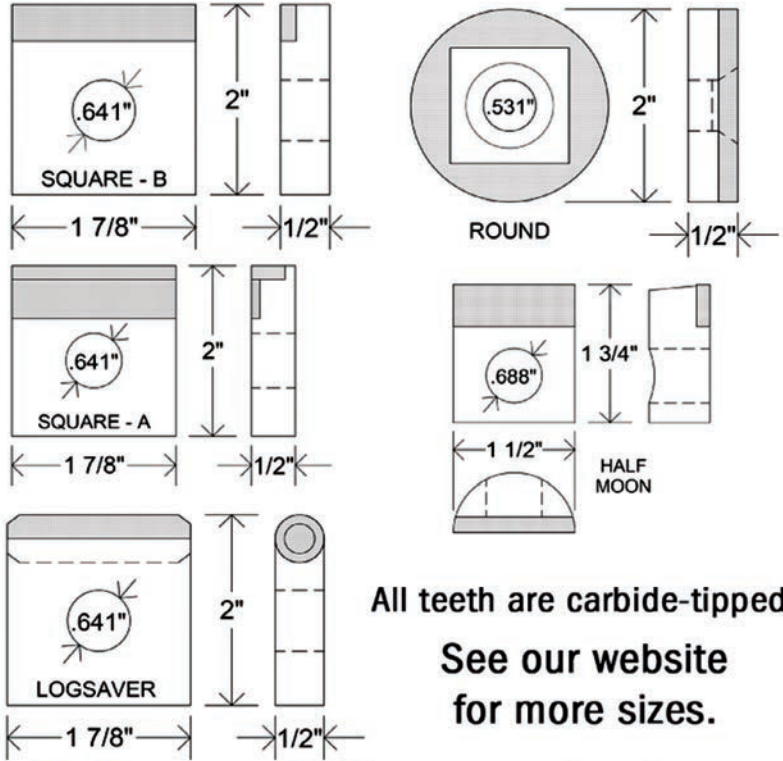

All teeth are carbide-tipped.
See our website for more sizes.

Universal Wearparts, Inc.



142 Old Hwy. 98 West
Tylertown, MS 39667
800-647-8440 • 601-876-3442
Fax 601-876-2342
sales@universalwearparts.com
www.universalwearparts.com



CLEARSPAN IS THE IDEAL SOLUTION FOR
YOUR **WAREHOUSING AND STORAGE NEEDS**

Up to 300' wide, at any length. Install on pre-cast or poured concrete. Work-safe environment with natural lighting. Low in cost per square foot. Interiors provide maximum storage, flexibility and maneuverability.



7-YEAR FINANCING
ZERO DOWN, NO INTEREST & PAYMENTS
- FOR UP TO ONE FULL YEAR -
Some restrictions apply

MACHINERY FOR SALE!



Bruks Drum Chipper



MAC Baghouses



Meadows Sawmill



S&W Resaw w/Run-around



Smart Single Notcher



Industrial Resources Dismantler



Precision 58\"/>



Yates Planer Mill w/Belt Drive



Newman KM16 for Rebuild



Cambio 26\"/>



Vecoplan Grinder

CMS Carolina Machinery Sales

704-288-1904

info@carolinamachineriesales.com
Charlotte, NC

See Featured Items and New Arrivals at www.carolinamachineriesales.com!



Buying and selling machines across the USA



CAE Twin Resaw

NEW Like us on Facebook
~ New Specials Often!

Great Buys On Pallet And Sawmill Machinery!

**Large Selection
of used equipment
& misc. parts**



Baker 4-Head

EDGERS

- Cornell Edger 6"
- Baker Gas
- Baker Slab
- Morgan Slab
- Miner 4" 2 Moveable

BAND SAWS

- Baker A Gas
- Fast Line Single
- Morgan Single
- GoFast Single w/Gas
- Kent 12"

NOTCHERS

- West Plains Single
- Kent Single

DISMANTLERS

- Disc Style
- Trace Trio



Rotochopper
(Slight Fire Damage)

SAWMILLS

- Cleerman 2 Head
- Block L.H.
- Tipton Scragg, Complete
- Hand Set Mills
- HMC Mill
- Edmiston 4 Head Block
- Helle w/Genset
- Forstall Mill
- Log Master LM-6
- Frick 01 Hydraulic
- Wood-Mizer LT40 Electric
- Jackson

TRIM/ CHOPSAWS

- Pop Up Saws
- Morgan 2-Saw

- Cornell Chop Saw
- West Plains Chop
- Brewer Chop Line
- Baker Double Chop
- Morgan Chop

NAILERS

- 2000 GBN Excalibur
- Pallet Chief II
- Pallet Chief 170"
- Gap 960
- Viking® Duomatic
- Viking® 304 A

DEDUSTERS

- Brewer
- Roblin
- GoFast

CHIPPERS / GRINDERS

- 48" Precision Chip Pack, 3 Knife

- 58" Morbark 6 Knife Pac
- 84" Precision Chipper
- Montgomery Hogs
- Challenger Horizontal
- Arasmith 50-48 HSS

DEBARKERS

- Morbark 636
- Manitowoc Flail Portable & Ring

GANG SAWS

- Cornell 500 B
- Brewer 8112 w/Sizer
- Cornell CLB
- Single Arbor w/Sizer

MISC.

- Barn Cleaner
- Chamfer Machine
- Blowers, Many Sizes

- Chip Screens
- Yates A-62
- 4 Head Planer
- Baker Runaround Sys
- Single Head Planer
- 250 KW Genset
- Timesaver Sander
- Industrial Plywood Cutter
- 8' Round Table
- Torit 12 Bag House



Jackson Mill



**Complete
Tipton Scragg
Merchandizer &
Cut-up Line**

Many Decks, Unscramblers and Conveyors

WANTED
Any Sawmill - Pallet Mill Machinery.
Call L&L Today.

LEERAY & LUKE HORTON
218-372-4232
8948 Market St., Sturgeon Lake, MN 55783
E-Mail: llsales@frontiernet.net
WWW.LLSAWMILL.COM



PORTABLE YARD SAW
This portable chain saw is for cutting logs or packages of lumber. It is available with electric drive or 20 HP gas engine with centrifugal clutch. It features manual or electric start.



HIGH SPEED CHOP SAW
L-M high speed chop saw is available in standard sizes from 48 to 84 inches in diameter. It features a heavy-duty construction frame and saw ladder.



DECK SAW
Deck saw with sawbars of up to 12 feet in length are used to cut the largest of logs, and are also used to split logs length-ways.

VERTICUT 2000-M

Hydraulic vertical guillotine length stops can eliminate the need for a double even ending unit

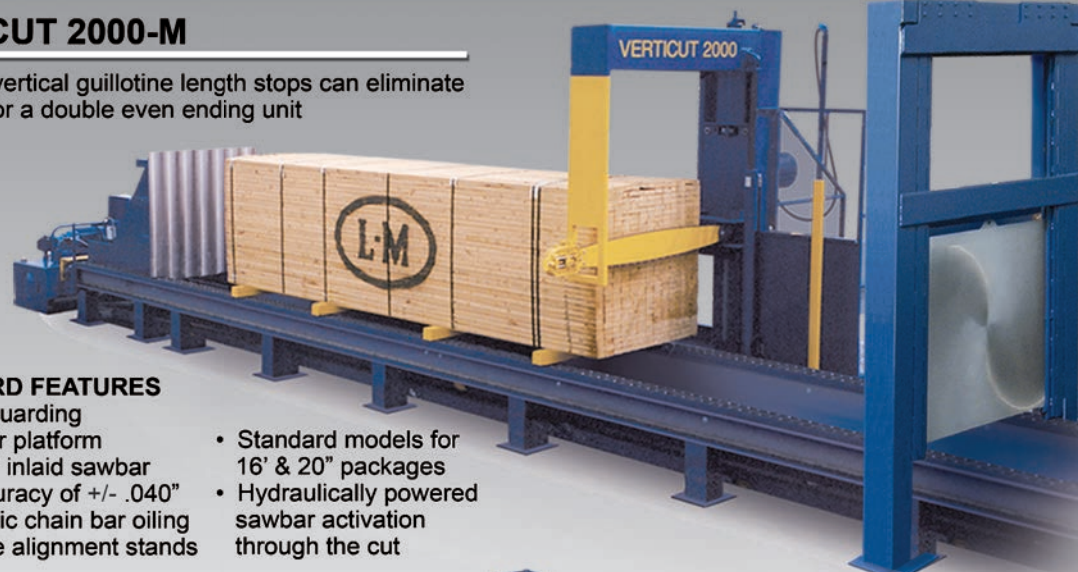

STANDARD FEATURES

- Safety guarding
- Operator platform
- "Stellite" inlaid sawbar
- Cut accuracy of +/- .040"
- Automatic chain bar oiling
- Package alignment stands
- Standard models for 16' & 20" packages
- Hydraulically powered sawbar activation through the cut

LS SYSTEM 2000 LOG SPLITTER

- Heavy duty Hydraulically powered splitter using onboard HPU.
- Adjustable travel speed using gear reduction for high torque and low power requirements.
- Splits logs up to 60" diameter by 20ft. long
- 54" vertical adjustment capability for slabs-quartering or sizing to mill capacity.



- OPTIONS AVAILABLE**
- Laser light saw guide
 - Modular package end squeeze
 - Modular even ending system
 - Automatic strapping system
 - Modular infeed/outfeed decks
 - Electronic length measurement with digital readout
 - Powered carriage positioning



**L-M EQUIPMENT
Company Inc.**
P.O. Box 82111,
Portland, OR 97282
Phone (503) 235-3146
Fax (503) 235-3916
1-800-228-0793
www.lmequipmentusa.com



Leasing available • Call for video

Need Parts to Fit Your Morgan Saws?

MILITARY BAND NOTCHER



- 5hp motor
- Hydraulic adjustable feed
- Indexable carbide cutters
- Adjustable width & height
- Can custom build

Sawmill Supplies & Equipment, LLC

- Board De-Dusters
- Multi-Head Trim Saws
- Product & Waste Conveyors

Office: 318-994-2116

www.sawmillsupplies.net

E-mail: sawmillsupplies@centurylink.net

Call Mona Tracy
1-855-298-8890 (toll free)
sales.universalmachinerysales@gmail.com
universalmachinerysales.net

Still Building the ORIGINAL
Low Profile Single Resaw

Engines, Power Units, Gen-Sets

Detroit Diesel, S53, 71, 92, 60
Remanufactured & USED
New & USED Parts

Twin Disk & Rockford Clutches & Parts
Power Unit Radiators & Gauge Panels
Specializing in

DETROIT DIESEL



Leid Diesel Service

Now 2 Locations to serve you:

267 Green Hill RD. - Newville, PA 17241

717-776-7725

N12574 Cty. Hwy. M - Thorp, WI 54771

715-669-3799

Are You Ready for the Latest Market Changes?

Hurdle Sawmills are EASY to INSTALL, OPERATE & MAINTAIN

- Proven in over 450 installations!
- Simple design with over 40 years of refinements and improvements
- A Hurdle mill followed by a resaw is an efficient, low cost, low maintenance replacement for an expensive grade bandmill installation
- For crosstie and pallet mills, our 2HB mill sets the standard for production
- Complete with 36" or 40" Challenger carriage, log deck, bar or chain log turner, offbearer belt, sawyer's cab, carriage drive, and setworks
- Optional Hurdle Vertical Edger eliminates expensive edgerman and downstream edger equipment
- Optional computer setworks, cant turners, hammer dog, top-saw, and more
- Go to www.youtube.com/HurdleMachineWorks to see it in action!

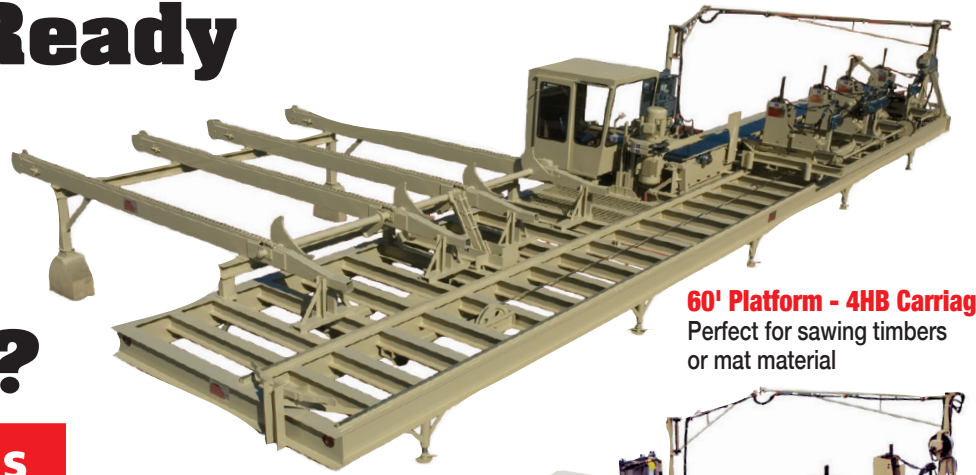

60' Platform - 4HB Carriage
Perfect for sawing timbers or mat material

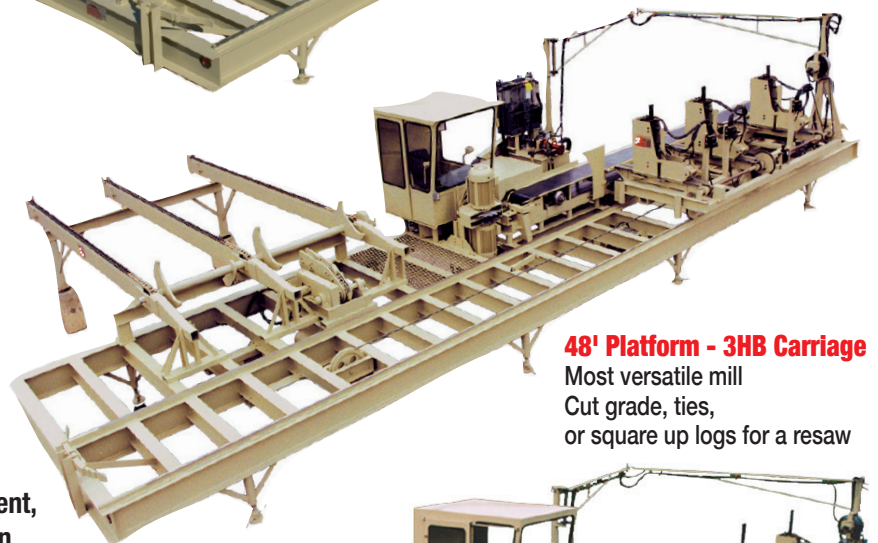

48' Platform - 3HB Carriage
Most versatile mill
Cut grade, ties, or square up logs for a resaw



40' Platform - 2HB Carriage
The standard for crosstie mills



A Hurdle Complete Mill Package will fit ANY size operation!



16195 Hwy. 57 Moscow, TN 38057

(901) 877-6251

www.hurdlemachineworks.com

Yielding Results Through Pallet Sortation

- Increases Production
- Decreases Labor
- Reduces Worker Injury
- Improves Pallet Inspection
- Eliminates Heavy Lifting and Manual Sorting



CONTACT US TODAY TO FIND OUT
HOW WE CAN ADVANCE YOUR
BUSINESS THROUGH AUTOMATION



844-886-3811
PRSGrouplnc.com

Stackers - Conveyors - Dismantlers - Trim Saws - Band Saws - Splicers - Platers - More

PALLET CUTSTOCK

Northern Dense
Hardwood & Aspen
Deckboards & Stringers
Notching Available
We Are Now Offering ISPM15 Compliant
Heat Treating For Our Lumber

Also Available Anti-Mold/Stain Treatment

Sagola Hardwoods, Ltd.

For the highest quality & best prices,
contact: Steve Shirkey

Phone: 906-542-7200

Fax: 906-542-3524

E-mail: steveshirkey@att.net

2 "TIPS" FOR MONTGOMERY HOG OWNERS!!

Inventors of the
"SHANKLESS" 2-PIECE HARDFACED HAMMERS
Bring You
2 TIME-PROVEN MAINTENANCE SOLUTIONS

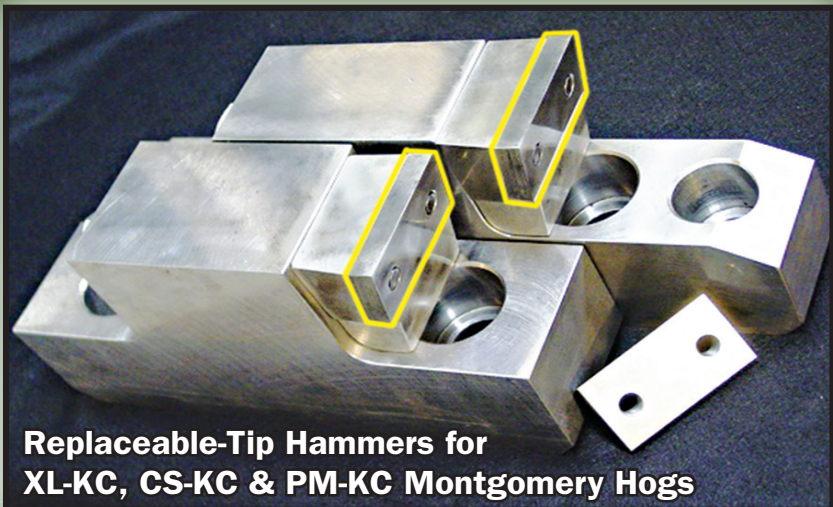

Replaceable-Tip Hammers for
XL-KC, CS-KC & PM-KC Montgomery Hogs



Replaceable-Tip Hammers and
Lower Teeth for Montgomery Hogs

Available in
Overlapping-Cut
& Hi-Rake Style,
Too!

**PRECISION-MACHINED OUT OF OUR SPECIAL MATERIALS,
THESE INSERTS WEAR LIKE HARDFACED PARTS!!**

- PARTS FIT - FIRST TIME, EVERY TIME!
- No more shipping parts back and forth to be rebuilt!
- No more waiting for parts to get back to you!
- No messy hardfacing welding and grinding of hammers!
- No more cracking/breaking off of hardfacing!
- You can "REBUILD" HAMMERS IN MINUTES!

Need Other Parts, Screens or Rebuilds?
Call the experts with over 40 years experience!

E ELLISON SALES, INC.
TOLL-FREE: 1-888-244-0161
FAX: 503-293-0816

EMAIL: sales@ellisonsales.com • WEBSITE: www.ellisonsales.com

BELL'S FIREWOOD PROCESSORS

- CAT Turbo Diesel Engine
- 54" Circular Saw
- 23.5" Diameter Capacity
- Single Joystick Control
- 42 Ton Splitter Cylinder



Many Models
and Options
to Choose From



Please Call for Details
1-888-995-1965

or visit us online
www.bellsmachining.com

Financing Available

Every Reputable Wide Band Supplier Offers...

- ✓ High Quality Swedish Steel
- ✓ 3" - 8" Band Width
- ✓ 16 to 20 Gage
- ✓ Double Cut Options
- ✓ Choice of Swage or Stellite

**BUT ONLY THE WOLVERINE
BY MENOMINEE SAW GUARANTEES...**

- Cutting Edge Plasma Welds
- The Industry's Highest Cutting Capacity Band Saw
- Quick Delivery from our HUGE Inventory
- Fast Sharpening & Exchange Program to Keep YOU Running
- Competitive Pricing

And **ONLY** Menominee Gives You Everything You Need
in a Wide Band Saw - Plus Expert Service
from the Industry's Most Knowledgeable Staff.

Got a Wide Band Problem?

Call Menominee Saw Today and You'll
Learn Why More Mills Trust the Pros!



**TOLL FREE
1-800-582-0470**

WWW.MENOMINEESA.COM

Email: info@menomineesaw.com



START BUILDING *your* BOTTOM LINE



HEADRIGS



RESAWS



EDGERS



SMART LOG
PROCESSING



MATERIAL
HANDLING



SHARPENERS
& SETTERS

DISCOVER HOW WOOD-MIZER'S INDUSTRIAL LINE OF EQUIPMENT CAN MAKE YOU MONEY.

Wood-Mizer owners around the world rely on our industrial solutions to produce accurate lumber while reducing capital, material, labor, energy, and maintenance costs for their business. Call today for a FREE catalog or design layout and Start Building Your Bottom Line with Wood-Mizer.

© 2015 Wood-Mizer LLC



800.553.0182 | woodmizer.com/bottomline

Wood-Mizer

HOGZILLA

MONSTER TUB & HORIZONTAL GRINDERS, Electric or Diesel Power



TC-1664SE Stationary Electric Powered HogZilla Shown.
Give us a call about converting your diesel powered machine to Electric Power.

CW Mill

Equipment Co., Inc.,
Sabetha, Kansas U.S.A.
Toll Free: **800.743.3491**
P. 785.284.3454 F. 785.284.3601
Email: hogzilla@cwmill.com

www.HOGZILLA.com



The Longhorn Saw Grinder

\$598

Jones Saw Tools

812-354-6981 or your local dealer



PAWTAWJOHN SERVICES, INC

(208) 687-1478 / www.pawtaw.com



Factory Authorized MTS Temposonics® Distributor and Warranty Repair Center

Cleereman carriage systems provider

FIRST-CLASS EQUIPMENT & DEPENDABILITY

AND EXCELLENT SERVICE AVAILABLE 24/7

Do you have internet access in your mill?
Ask us about our machine monitoring capabilities.

Check out our Linear Carriage System

User Friendly. Easy Setup.
Efficient. Affordable.



Your Most Reliable Source for New, Used & Customized Machinery. Call Mona Tracy Today!



The **RUN-A-GADE** Bandsaw Pallet Disassembly System



TRIO
3-Head

BANDSAW DISASSEMBLERS!

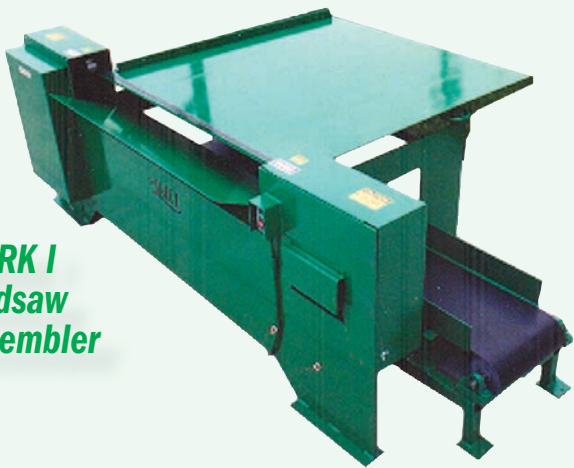

MARK I
Bandsaw
Disassembler



SOLO Single Head

DISC TYPE DISASSEMBLERS!



**High Speed Pop-Up
Cut-Off Saw**

LUMBER SAVERS!



TRIM TRAC
End Trim Saw



Manual Chop Saw



SN20 Automatic Notcher

NOTCHERS!



BLOWERS!



UNIVERSAL
MACHINERY SALES, INC.

Call Mona Tracy

Toll Free 1-855-298-8890
or **812-298-8090**



- Corner Rounder
- Chamfer
- Unstubber
- Pallet Sizer
- Round Tables
- Specialty Machinery

www: universalmachinerysales.net

E-Mail: sales.universalmachinerysales@gmail.com

Leasing & Financing Available

The Most Innovative Equipment is a Phone Call Away..



**NEW
4-Head
Design!**

Low Profile BAND RESAWS

Single & Multi-Head Models
Available with or without return
Hands-free return eliminates one operator
Save labor - Save money!



NEW Multi-Head TRIM SAW

2, 3, 4 or 5 head models
Adjustable heads with variable speed, chain feed
drive motor with starter
20" x 40-tooth carbide blades
Quick change adjustable to length

NEW! ANGLE CHOP SAW

Cuts 0° to 45° on a 2x8
and 0° to 40° on a 2x10
Fast Cycle
Easy to set up and operate
Guarded blade for safety



Robo Chop UPCUT SAW

Automatic push feeder,
30,000 B. F./shift. Stacks
boards 5 high & up to 16
wide. Up to 16 ft lengths



Military BAND NOTCHER

Fully Adjustable notch-length of board
Option: Double groove notch and 14" blade
to cut board into two strips



Hopper-Feed BLOCK SAW

Cuts 2x4 & 4x4 blocks from 24" drops
30 hp, 3-phase motor/starter



Self Dumping STEEL HOPPERS



REPAIR BARS!

Call for Pricing!



STAKE MACHINERY



Woodsave MOBILE HEAT TREATING for pallets, crates, containers & other wood products.

kiln-direct.com

The leading provider of kilns for lumber, pallets and firewood



- Portable turn key units with fast treating time
- Heat treats and dries in the same chamber
- Computerized record keeping
- High efficiency direct gas heating
- Aluminum or stainless steel chamber
- End-load models
300-1000 pallet capacity
- Side-load models
280-700 pallet capacity
- Piggy-back system for insulated van body or container



- Wood waste or gas heat
 - Easily meets 160F/75mins
 - Heat treat in 8-16 hours
 - Kiln dries green firewood in 1-2 days
 - 6 cord (MiniQuick) up to 24 cord
 - Baskets for optimized airflow are available
- MiniQuick firewood kiln has been specifically designed to dry and HT firewood quickly and efficiently



- 100% aluminum construction
- Gas, hot water or steam heated
- Power venting with Heat Recovery
- Bi-fold door with electrical operation is optional upgrade
- Computerized control with wireless communication to office
- Loading capacity from 9000 bf to 21000 bf

Call us today and find out how our pallet, firewood and lumber kilns can increase your profit...

phone 910 259-1624
fax 910 259-1625
www.kiln-direct.com

P.O. Box 159
200 A Progress Drive
Burgaw, NC 28425

Pallet Dip Tank Key Design Features:

- Dip tank is fabricated in 1/8" thick stainless steel, type 304, with external painted enamel mild steel structure.
- Standard pallet carriage for pallet stack up to 114" tall and maximum 2500 lbs weight. Dead packed cut stock can also be dipped.
- Tilting carriage is fabricated in stainless steel and mild steel.
- Tilting carriage has clamp system to insure pallets or lumber is submerged.
- Hydraulic system is used for all mechanical operations.
- Estimated dip cycle for pallets is 4 minutes and is user defined.
- PLC control system with remote control for initiating the dip cycle. Dip time and other parameters are adjustable in the control cabinet display.



Eagle Dip Tanks Complete Dip Tank Systems

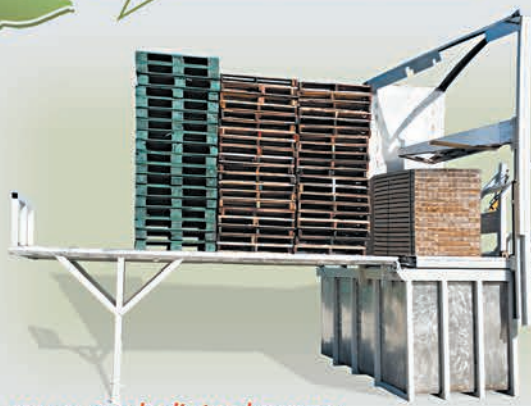

www.eaglediptanks.com
910 259-9794

We Specialize in Dense Hardwood or Poplar:

- Pallet Deckboards (1x4 & 1x6)
- Stringers (Notched & No-Notch)
- Band-Groove Components
- Custom jobs no problem

For more information

Contact: Keith Barbo
E-mail: kbarbo@wvsr.com
304-472-8131 ext. 111
or 304-439-0392 Cell
Fax: 304-472-0212

WV Forest Products

Website: www.wvsr.com

PO Box 9, 16 Lumber St. • Buckhannon, WV 26201

Radial Arm Saw

Delta ShopMaster Industrial Saw

— in great working condition. Rarely used!

Serial #07L 16663 2007 52-PC

13.0/6.5 Amps,

60 Hz,

230/460V,

3-Phase.

\$3,500 OBO



Contact

Tom Gannon

509-453-0386

or cell

509-979-7768

PARTS & SERVICE

Forest-All, C.M.C., C.S.P., ^{35 Years} Experience!
Hilltop Equipment

DICK NOLIN SAWMILL SERVICE

603-724-3942

The Best Fitting Sorter Parts For Sawmills!

Need faster service and lower prices for sorter & other parts for your mill? We can help!



Most of our parts are custom made — by hand — to your specs!

"Send us one of your old parts, we'll build you a better one!"

- Next day shipment on sorter parts
- Wear strips cut to spec
- UHMW Channel
- FREE samples

Also: J-bars, C-hooks, pusher lugs, diverters, chain lug rollers, UHMW sprockets, plus lots more!

Brooklet Plastics, Inc.

800-842-5258

e-mail: bplastic@frontiernet.net

FRICKCO, INC.

We manufacture & sell parts for Frick sawmills.

We also sell new Frickco sawmills.

Call for your nearest dealer.

740-887-3799

South Bloomingville, Ohio

Turn Wastewood Into Profits!

Sell your wood at \$300 or more per cord with the **WOOD-PAKer**, a high-production, easily operated shrink wrapping machine. 7 Models • Financing Available

B & B Manufacturing

e-mail: bbmfg@sprynet.com

http://home.sprynet.com/~bbmfg

800-654-5320

NOW BUYING

Used Pallet and Pallet Recycling Machinery.

1-800-348-0703

NOBLE MACHINERY CO. INC.



 WWW.FRONTLINEEQUIPMENT.NET

FRONTLINE EQUIPMENT, LLC

 Out Front Where Things Happen

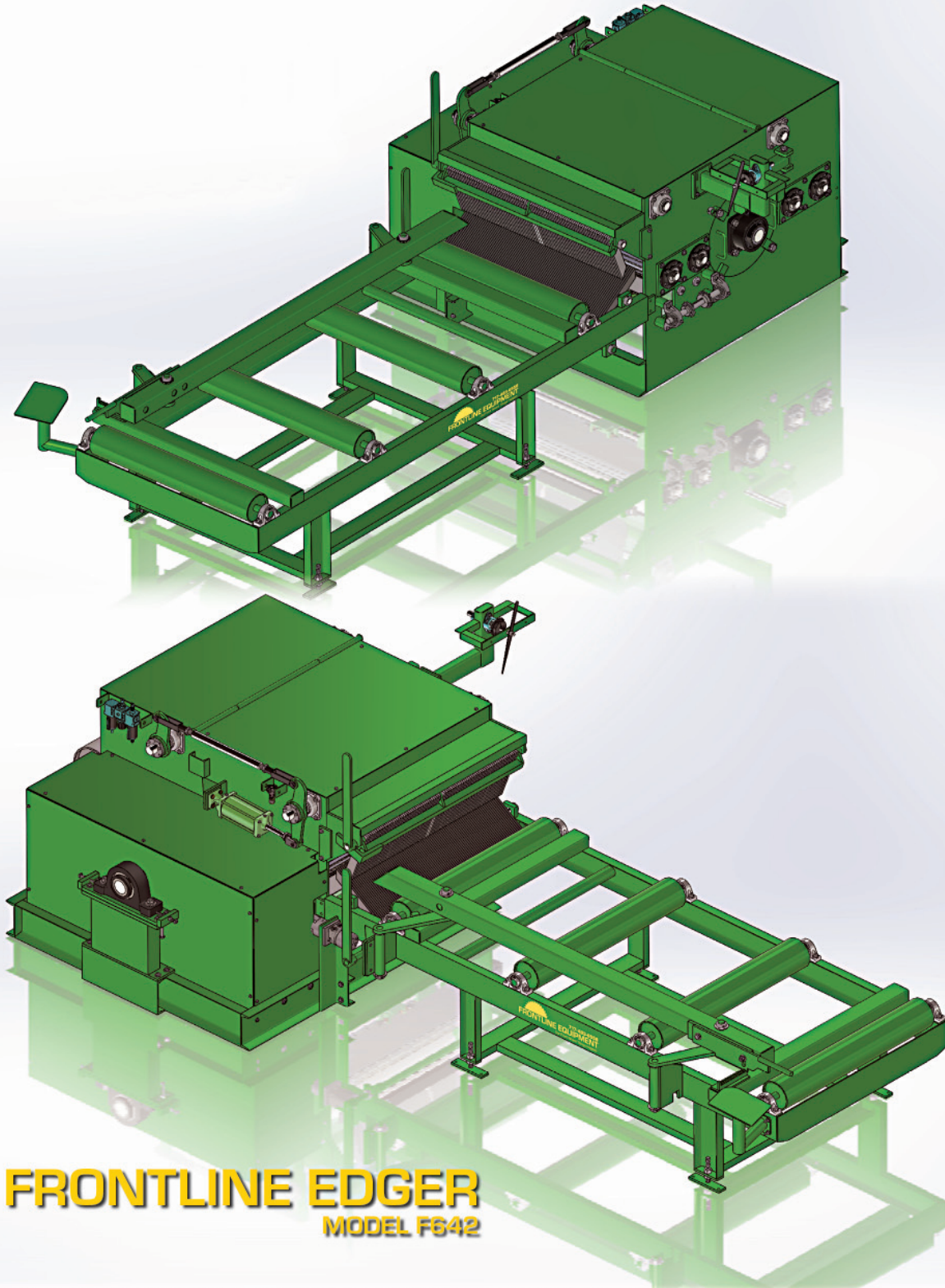

FRONTLINE EDGER
MODEL F642

INTRODUCING FRONTLINE EDGERS

*Now in
Production!*

The F642 HD Edger is designed and patterned after the long lasting and dependable Reckart Edgers. The same Heavy Duty construction and quality craftsmanship you have come to expect from Reckart Edgers is now built into the FRONTLINE Edgers with most parts being interchangeable. Call today for information on the New FRONTLINE Edgers and other equipment FRONTLINE is now manufacturing.

9267 Front Mountain Road
Allensville, PA 17002

717-483-6556

Fax 717-483-6051

Email parts@frontlineequip.com



Blowers F42 & F26



Log Turner FT40



Waste Conveyor

ERVIN
ERVINUSA.COM

LARGEST TRAILER DEALER IN NORTH AMERICA

15 LOCATIONS NATIONWIDE

53' x 102" x 13'6"
PALLET TRAILERS

Plate Trailers • Swing Doors • Wood Floors • Group Pricing Available

LARGEST TRAILER INVENTORY AVAILABLE IN THE PALLET INDUSTRY

Also checkout our large inventory of new Glider Trucks!

ErvinUSA.com **877-873-6863**

Minimize Log Splitting

Save time and money by quickly inserting our heavy 14 ga. S-Irons into the ends of logs and timbers to reduce splitting or checking. Unique ribbed design provides greater holding power. Available in 4", 5" or 6".

QUOTES ON REQUEST

1-800-325-3770 fax: 636-305-1119

WESTERN WIRE PRODUCTS CO
Since 1914 770 Sun Park Dr. Fenton, MO 63026
www.westernwireprod.com sales@westernwireprod.com

Selling at Auction
Ewing, KY - August 15th

2003 Cat 924G Loader

See ad in this issue or call **1-800-334-4395** or visit www.tristate-auction.com for more info.

G401 Sawmill Networks **2 YEAR WARRANTY**

Compare prices and features. Our G401 Networks is the ultimate saw controller, packed with features, rugged, and built to last with non-proprietary components. Call us or visit our website for more information on our other sawmill control solutions: Edgers, Trimmers, Resaws, Scraggs, Tallies, Customized Systems and more!

Thomas Industrial Controls
www.thomasic.com 1-866-899-0495

The Leader In Chain Bar Repairing Since 1961

: Celebrating 50 Years :

Cut off bars for bundled lumber and cut off applications
We repair all types of bars and offer custom manufactured bars for all aspects of the wood products industry.

CHAIN BAR REPAIRING

CALL TOLL FREE
1-877-SAW BARS (729-2277)
or 503-774-4266 www.chainbar.com

Email: chainbar@comcast.net
BILL DAVENPORT • 5425 SE Johnson Creek Blvd. • Portland, Oregon 97222

CALL FOR PRICE QUOTES

COMPLETE LUMBER REGRADING LINE

LOCATED IN PA

LPS EQUIPMENT & ACQUISITION CO.

800-598-3651
WWW.LPS-INC.COM
731-986-4351 • sales@lps-inc.com

ESI Crosscut Solutions, Inc.
 E5763 County Road B • Manawa, WI 54949
 Ph: 920-596-2330 • Fx: 920-596-2324
 crosscut@wolfnet.net

**Pneumatic
OR
Mechanical**

The industry's most durable pneumatic and mechanical cut-off saws, delivering smooth, accurate cuts for the manufacturing of flooring, windows and cabinets. Both saws are available with a cool mist lube system for the processing of aluminum.



Available in left or right hand

Mechanical Saw -
No compressed air required

Pneumatic Saw -
Cushioned air cylinders

www.crosscutsolutionsinc.com



CLEEREMAN INDUSTRIES

Not Just Carriages!

- Carriage Drives Hydrostatic & Electric
- Airbag & Hydraulic Cable Tensioners
- Custom Material Handling Systems
- Bar Type Log Turners 2500 - 3500 lbs
- Sawyers Cabs & Control Cabs
- Contact Us Today For Information

www.cleereman.com | 715-674-2700 | 5500 Pine St., Newald, WI

Bevel Buddy™ makes chipping more profitable



- Reduce knife changes and resharpening costs
- Less downtime = more production time = BIGGER PROFITS
- Extended life for chipper parts such as bolts, knife holders and clamps
- Use less fuel with sharper knives

MORBARK

Bevel Buddy is available at all Authorized Morbark Dealer locations. To find a dealer in your area, go to www.morbark.com/find-a-dealer or call 1.800.255.8839.

High Performance Wood & Bark Hogs



Montgomery hogs are engineered to require less horsepower and produce consistent end product with a minimum of fines





- ✓ Lower Input Cost for Power
- ✓ More Efficient Burn in the Boiler
- ✓ Higher Quality of Mulch
- ✓ Rugged Construction
- ✓ Straightforward Maintenance

Protect your investment with parts engineered to perform.

MONTGOMERY INDUSTRIES INTERNATIONAL

2017 Thelma Street • Jacksonville, Florida 32206
 Ph> 904.355.5671 • Fax> 904.355.0401
www.montgomeryindustries.com

DUST FREE BOARDS, FAST M6 SIDEWINDER DeDUSTER



Feeds boards through side-to-side, increasing efficiency by 91%

CAPACITIES:
 Width: 3½" to 6"
 Thickness: 3/8" to 1¼"
 Length: 28" to 62"

Feedspeed: 140 FPM
 Four Electric Motors: One 2-HP, Three 1-HP
 Features a non-slip board feed & separation

Compatible with Resaws with five or more heads!

BAKER Products 573.663.7711 800.548.6914 www.BakerProducts.net info@BakerProducts.net



IN THE MARKET FOR USED/REFURBISHED HOGS... AND MORE? CHECK OUT OUR INVENTORY FOR CAN'T MISS BARGAINS.



**Precision 58in 6K ChipPack,
10317-1**



**Morbark 48in ChipPack,
10315-1**



**Morbark 58in 3K ChipPack,
10313-1**



**Montgomery 42PM-HZF,
150hp, 10272**



**Montgomery 50PM-HZF,
10294-2**



**Montgomery 26HD-HZF,
10311-1**



**Montgomery 34HD-HZF
Horiz. Feed Hog, 10287-2**



**Montgomery 45CSKC,
10076-1**



**Montgomery 26HD40 BloHog,
10054-1**



**West Salem 2822BH,
10295-1**



**Montgomery 57XLKC,
10225-3**



**C-200-Low RPM Grinder,
10314-1**



**Montgomery 18HD Hog,
10318-1**



**24-Unit Peerless Bin,
10312-1**

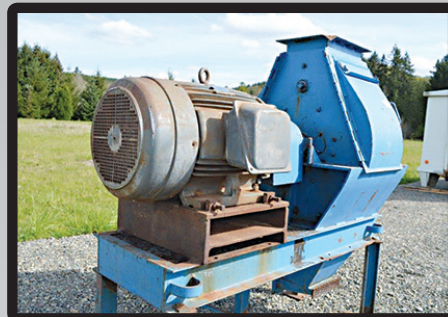

**75hp Champion 15x22 Hammermill,
10279**



**Baldor 150hp 1185rpm TEFC,
10302.01-13**

**Already have a Montgomery Hog?
We supply all the parts you'll need!**



ELLISON SALES

Toll-Free: 888-244-0161

E-mail: dan@ellisonsales.com • www.ellisonsales.com

**Portland,
Oregon**

NOBLE MACHINERY CO.

- New Pallet Hawg Band Dismantler, In Stock
- New Waechter Power Feed Trim Saw
- Bronco 200 Nailing Machine
- Cantek 12" Wide Chain Feed Gang Rip Saw
- Cemco 84" 6 Spdl. Vertical Borer
- Dewalt GE 16" Radial Arm Saw
- Diehl 750 Straight Line Rip Saw
- Hazlethorn R-180 24" Up-Cut Saw
- Hazlethorn T-145 10" Wide Cant Sizer
- Hazlethorn Lumber Shear
- Heartland Dbl. Head Resaw w/Return
- Kenwel Jackson 96" Double Notcher
- MMT Sgl. Head Notcher, 15HP
- Mid-Oregon Trim Scrap Grinder
- Morgan Double End Trim Saw
- Pest Heat Treat Chamber
- Piche 4-Head Multiple Trim Saw
- PRS Chain Feed Trim Saw
- Rayco Pro Pallet Nailer w/Stacker
- Third Man Nailer
- Waechter 2-Head Horiz. Resaw
- Weinig 5-Head 4" x 9" Moulder
- West Salem 2-Stage Vertical Grinder
- Willow Creek Economy Notcher
- Rebuilt Whirlwind Up-Cut Saws
- Parts for FMC, Hazeldine & Morgan

1-800-348-0703
www.noblemachine.com
 E-Mail: noblemach@aol.com

FOR SALE!

Single Arbor Gang w/Sizer

LEERAY & LUKE HORTON
218-372-4232
 E-Mail: llsales@frontiernet.net

Kittrell Sawmill Equipment Listings

Call Jacqueline Kittrell To Locate or Sell Equipment

www.kittrellsawmillbrokers.com

931-698-3342
931-797-6284

PO BOX 505, COLUMBIA, TN 38402



GMC Truck w/Prentice Loader

Everyone has surplus equipment that could be earning CASH.

Our equipment brokering service is the way to go!

Let us handle the hassles and headaches for you.

Call us today to get started.
 You can benefit like others...



2012 Meadows #3 Mill, Nice Outfit (IL)



Viking Duo-Matic Nailer (GA)



Log Bucking System (TN)



Mellott 80' (4) Strand Sorting Chain (PA)



Jackson Shavings Mill (KY)



Concept M200 Bagger (KY)

✓ **OUT OTHER LISTINGS ONLINE. NEED TO SELL SOME SURPLUS MACHINERY? CALL US NOW TO GET STARTED.**

Email: info@kittrellappraisals.com

Stop making \$20 a ton SAWDUST and
START MAKING \$100+ TON LUMBER

Find out more at
www.brewcoinc.com



THE PIONEER OF THE THIN-KERF RESAW

HEADQUARTERS:

607 Front St. • Central City, KY 42330
800.237.6880

Wood-Mizer
CONFIGURATOR

Build & Price your Sawmill at
mywoodmizer.com

ARMORHOG
 Extreme Duty Grinder Parts

ARMORHOG® uses NITROGRIT™
 A proprietary blend of carbide found to best suit grinding applications.



ARMORHOG® is totally focused on providing top quality, Extreme Duty replacement parts for all brands & models of industrial grinders, specializing in rigid hammer grinding applications.



Arm Your Hog With ARMORHOG!
 Extreme duty aftermarket grinder parts for all grinders.

www.armorhog.com

800.743.3491 • sales@armorhog.com

BATTLE READY • WEAR RESISTANT • BEST VALUE





Customization, Reliability and Quality for 50 Years

It's what you expect when you buy a Cooper Scragg

Overhead and Sharp Chain Scraggs With Several Models to Fit Your Needs



Skewing Overhead



Standard Overhead



Precision Sharp Chain



Standard Sharp Chain

Upgrade your Cooper Overhead With:
Vertical edgers, band saws, pivot dog for faster cycle times, skewing for increased yield on marginal logs, X/Y scanning or 3D scanning, and the graphic log display

Give us a call at **478-252-5885** to find which machine works for you!
For more information: www.coopermachine.com

PO Box 550 /50 W Smith St, Wadley, GA 30477 Phone: 478-252-5885 Email: info@coopermachine.com

Wood Fired **BOILER PARTS** Supplies and Materials

PARTS IN STOCK

BOILER REPLACEMENT PARTS

Hurst Boiler is a major supplier of boiler parts and controls that are commonly found on most boiler systems. We warehouse and stock parts and supplies for gas, oil, coal or solid fuel systems. No matter the maker, Hurst can fill all your part needs.



The Industries Largest Supplier of Wood & Biomass Fired Boilers and Related Boiler Room Parts and Supplies

- Pumps
- Controls
- Gaskets
- Valves
- Burners
- Refractory
- Fire Bricks
- Water Softeners

CALL Parts Sales Dept. 1 877 774-8778
24 / 7 After Hours Parts 229 221-3338

OVERNIGHT DELIVERY



HURST BOILER & WELDING CO., INC.

100 Boilermaker Lane • Coolidge, GA 31738-0530
Tel: (229) 346-3545 • Fax: (229) 346-3874
email: info@hurstboiler.com



hurstboiler.com

"Authorized Dealer" for



U.S. Blades is your single source supplier of high quality knives, saws and related maintenance supplies for Sawmills & Chip Mills. With locations to serve mills throughout the Southern wood belt to the Northeast, U.S. Blades is here to support the Forest Products Industry providing new products as well as repair services.

U.S. Blades knives and saws are "Feared By Trees Everywhere."

U.S. Blades also has field service technicians for installation and service of all Armstrong equipment with many years of Armstrong parts and equipment knowledge that will benefit our customers.

Armstrong SDSC Territory Map
Shaded areas of this map represent U.S. Blades "Authorized" selling region.



Stocking Locations for "Genuine Armstrong Parts and Equipment"

LOCATIONS AUTHORIZED TO SELL:
Florence, SC • Hampden, ME • Meridian, MS



usblades.net • 800-862-4544

Total Log Scale Inventory Solutions *In Business for 70 Years!*

Software • Caliper • Barcode scanner • GPS • Logtags

Now offering a complete line of tools to keep track of your inventory from start to finish

- Digitech Professional Caliper—An all-in-one rugged computer caliper that allows you to scale logs. LogScale software is designed to collect, process and report any load and log data and send that data to a Log Scale Suite for Haglof Management System's database. With it's Bluetooth capability, the Digitech Professional works with a wide range of accessories, such as a barcode scanners and GPS.
- Log Scale Suite for Haglof Management Systems - Use it to create and manage contracts, price lists, tickets and loads as well as scale logs, calculate volumes and manage log inventories.
- LogTags—Durable plastic tags with many styles available to choose from to fit your needs and let you stand out. We even carry bio-degradable tags that are safe for the pulping process.



HAGLOF INC
 PO Box 2548, 100 Solleftea Drive • US-39130 Madison, MS • USA • Phone +1-601-856-5119 • Fax +1-601-856-9075
 sales@haglofinc.com • www.timbercruise.com • www.logtags.com • www.haglofinc.com

UNBEATABLE PRICES ON NEW & USED MATERIAL HANDLING EQUIPMENT!



Kimber 4488 Log Shaver
 100 yards per hour!



New & Used Conveyors



New & Used Log Decks — In Stock!



Dry Kiln & Hurst Gas Boiler
 20,000 board ft. per side!



40 Unit Chip Bin



25 HP Ingersoll Rand w/30 HP Motor & 150 gal. tank (used)



6' x 12' Black Clawson Shaker Screen w/5 HP motor



Prentice 310 E Knuckleboom (used)



Acrowood Slant Disk Chipper, 60", w/150 HP motor (used)



Bio Mass Burners



Barge Loading Facility
 100+ acres w/indus. buildings available. Located on TN River.



New Single or Dual Truck Loading System



90 Ton/Hr. Complete Chip Mill

Need Something Else? Call Us... If We Don't Have It, We'll Find It!

www.CrownMachinery.us

harvey@crownmachinery.us

Kimber Wood Shavers are distributed by Crown Machinery, LLC



CROWN MACHINERY

SCOTTSBORO, AL

256-218-3045

Fax: 256-218-3062

Sales, Service, Engineering, Installation and Removal of Equipment

Fast, Durable, Productive Machinery For Pallet & Lumber Mills - Recycled & New Producers!

26 years Building Dependable Machines Heartland Fab. & Machine



B54E
Band Saw
Pallet Dismantler



STS10
Single
End
Trim Saw

Band saw pallet dismantlers, single end trim saws, multi-head trim saws, chop saws, disc-type pallet dismantlers, conveyors & conveyor systems, rotary tables and custom machinery.



Heartland Fabrication & Machine Inc.

Pulaski, WI Phone: 920-822-2215, Phone/Fax: 800-422-2215

www.heartlandfabandmachine.com • e-mail: heartlandfabandmachine@gmail.com

1-920-822-2215

**Hydraulic
Joystick
Valves
for
Sawmills**



PROVEN!

MADE IN USA

- Over 30 years reliability
- Precise metering
- Self centering
- Easily serviced
- Replacement parts in stock

E **ELLISON SALES INC.**
888-244-0161
sales@ellisonsales.com

KASCO SharpTech

Aggressive • Clean Cutting • Sharp Out of the Box

MAXIMIZE YOUR MILL



WITH

**WOOD
MAXX**
Premium Band Saw Blades

Precision Ground Teeth • Tight Tolerance Balanced Set • Induction Hardened • High Carbon US Steel

877.366.1696

www.WoodMaxxBlades.com

Selling at Auction
Oakland, MS - August 22nd



**Ameri-Mulch Mini Mate
 Mulch Coloring System**

See ad in this issue or call
1-800-334-4395 or visit
www.tristate-auction.com for more info.

**PRECISION-MADE SHAFTS
 FOR ALL MONTGOMERY
 HOGS & BLO-HOGS**



**ELLISON SALES, INC.
 PORTLAND, OREGON
 888-244-0161
 dan@ellisonsales.com**

Nailer For Sale
 '83 Viking Duo-Matic Nailer
 Make Offer!
 Call Walter @ **716-355-4392**



BAND WHEELS!

- ✓ **Blades Not Tracking?**
- ✓ **Bad Cuts?**
- ✓ **Worn Crown?**
- ✓ **Short Blade Life?**

We've been re-crowning, re-banding wheels and manufacturing new wheels for OEM band saw suppliers for years! We know what works!

QUALITY WORK • EXPERT ANALYSIS • REASONABLE PRICING • PICK UP & DELIVERY

PLUS! — New Sheaves (single or multiple grooves) and New Wheels & Hubs (20" to 40" dia. and 1" to 5" blades)

We make your operation run smoother — at an economical price!

**Resaw Owners Can De-Dust Boards As They Saw
 With "Ram Jet" Replaceable Insert Guides**

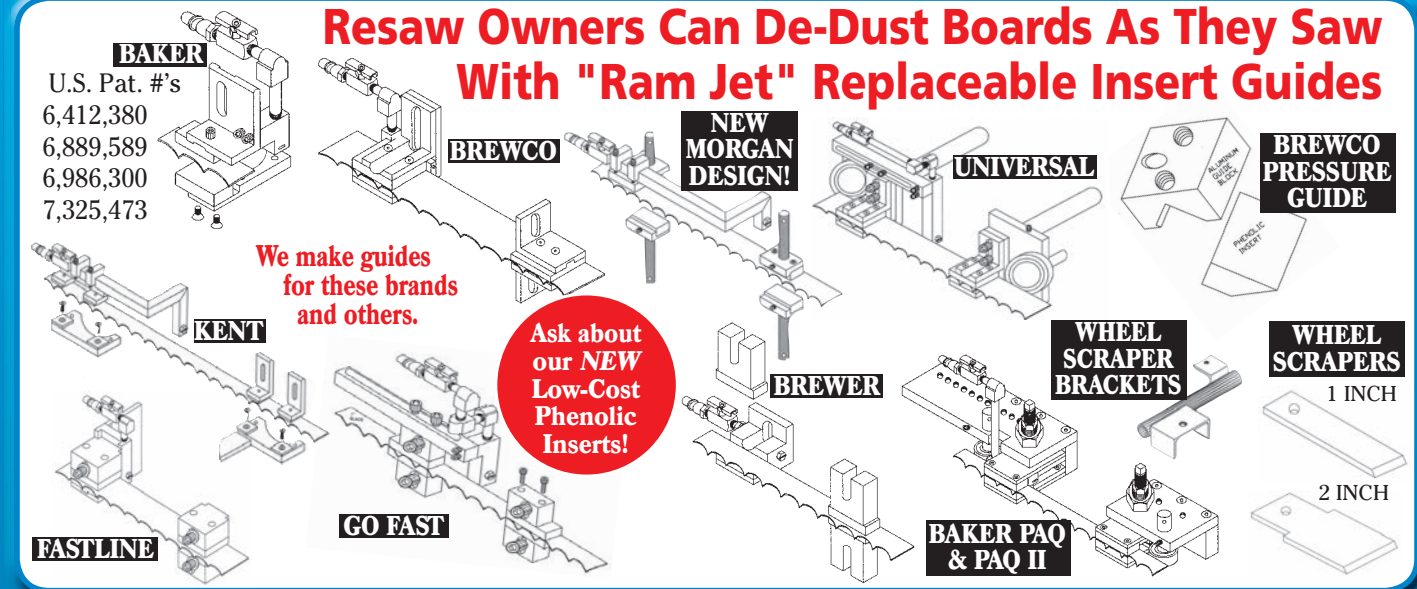

U.S. Pat. #'s
 6,412,380
 6,889,589
 6,986,300
 7,325,473

BAKER **BREWCO** **NEW MORGAN DESIGN!** **UNIVERSAL** **BREWCO PRESSURE GUIDE**

KENT **WHEEL SCRAPER BRACKETS** **WHEEL SCRAPERS**
 1 INCH
 2 INCH

FASTLINE **GO FAST** **BREWER** **BAKER PAQ & PAQ II**

We make guides for these brands and others.

Ask about our **NEW Low-Cost Phenolic Inserts!**

www.tri-starmetalsinc.com

- **NEVER** buy another set of guides — just replace inserts!
- **NO** board deduster or hand dedusting needed
- **NO** modifications to your saw required. Just dust-free boards as you cut!

For details, call Ed
800-685-2899
 or 270-281-4500

TRI-STAR METALS INC.
 1415 East Parrish Ave. • Owensboro, KY 42303
 FAX: 270-281-4511 E-Mail tsmi1@roadrunner.com

MADE IN USA

K.M.C. Model 882HD Double Bandsaw

We can provide the best machine to meet your application and production requirements!

- ✓ Self Adjusting Catty Track Hold Down System
- ✓ Harden & Baked Chrome Steel Paddle w/Lubrication System
- ✓ 18" Min. Length
- ✓ 3/8" to 6" High Material Climb from Blade Height — Optional 12" Climb
- ✓ Max Cut Height 8"
- ✓ Max Cut Width 8"

OPTIONAL: Digital Readout • Rubber Belt or Harden Steel Chain Feed • Floating Air Guide • Head Drive, Electric, Hydraulic or Lineshaft • Hydraulic Power Unit

717-859-4977

KEYSTONE KMC MACHINERY CORPORATION
 20 Cocalico Creek Rd. • Ephrata, PA 17522

www.keystonemachinery.com Fax: 717-859-4979



**NEW PRECISION
 58" Chipper**

Ben Jones Machinery
 Div. of Dickert Enterprises, Inc.
 Industry's Most Trusted Source
800-241-8983

See more equipment at
www.benjones.com

New Meadows Carriages To Fit ANY Sawmill

112 Years of Experience
Makes Meadows The Perfect Choice To Design *Your* Next Carriage



Meadows Center Dogging Carriage/Center Dogging Headblock

- Carriage frame lengths from 10 feet and up. Openings from 33" to 44"
- Center or side mounted hydraulic board dogs with push button controls.
- Hydraulic "on-the-headblock" turners available, push button controls.
- Setworks with hydraulic drive, electric controls & rotary encoder or linear temposonic rod.
- Carriage wheels from 6" to 10" diameter for "T" or hex rail systems.
- Hydrostatic carriage feeds and hydraulic power sources also available.

MEADOWS MILLS, INC.
800-626-2282

www.meadowsmills.com • e-mail: sales@meadowsmills.com



Hardwood Pre-Cut Pallet Material

- **#1 and #2 Material**
(Available in deck boards and runners.)
- **Various Sizes & Lengths**

Other Products Available
 Sawdust • Mulch • Raw Bark • Boiler Fuel
 Chips • Chunk Wood • & MORE

Call **740-226-2090** | www.millwoodinc.com

CEMARLINE
 www.cemarelectro.com

CEMAR ELECTRO INC.
LASERS

GREEN!
 5,15,30,50mW

5-30 mW RED LASER

- Industrial Strength
- Patented Linear Optics
- 48-Hour Repair Service
- Powershift™ Technology
- 2-year Warranty

Call Toll Free Today:
1-800-298-5273
 Fax: 518-298-2927

YOU CAN'T SURVIVE WITH THIS...

Cut with Circle Saw
with .3125" Kerf

Total # of boards: **15**

Total Board Feet: **132.2**

% Overrun of
Doyle Scale: **12.8%**

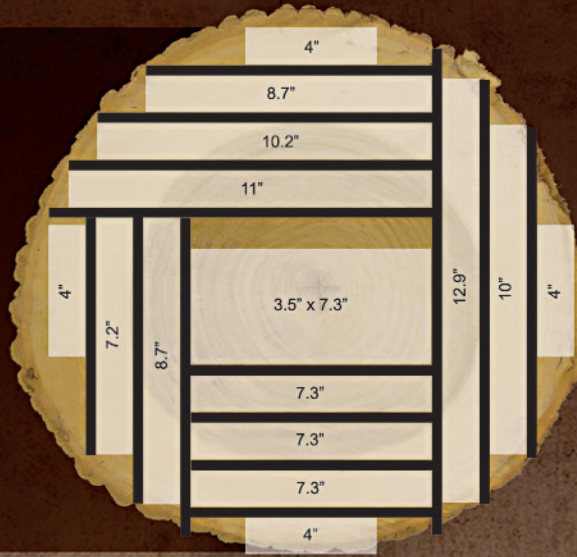

BUT YOU CAN THRIVE WITH THIS!

Cut with Bandsaw
with .082" Kerf

Total # of boards: **19**

Total Board Feet: **158.25**

% Overrun of
Doyle Scale: **35%**

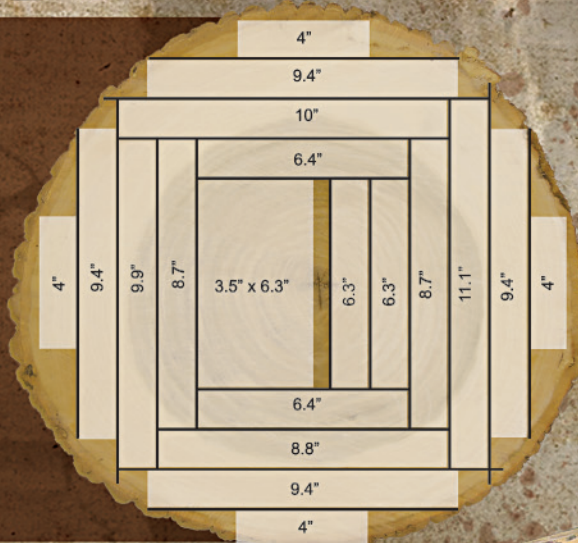

BREWCO B-1600... 19.8% YIELD INCREASE!

Log diagram demonstrating actual yield savings of a B-1600 resaw system compared to a standard circle saw operation. This is based on a 16 1/2" diameter log 12' long having a Doyle Scale of 117.2 BF.



HEADQUARTERS:
607 Front St.
Central City, KY 42330

800.237.6880
www.brewcoinc.com



THE PIONEER OF THE THIN-KERF RESAW

For Many Years The Wood Industry's Most Trusted Source For Previously Owned Equipment!

**Don't See
What You're Looking for Here?
Search Our Complete Inventory
at www.benjones.com!**



BAKER 5-Head Horiz. Resaw



MELLOTT 80' Vibrating Conveyor



MORGAN Slab Edger



UNITED Mag Bed Knife Grinder



RECKART Cant Catcher/Slab Drop



PENDU Board Stacker

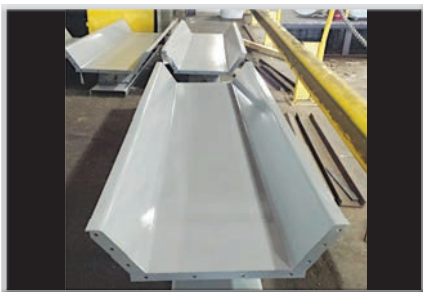

New WEBSTER Vibrating Conveyor



SALEM Edger



TYRONE BERRY 270 Carriage Drive



85' Green Chain



USNR Optimized Edger



WRIGHT 150 Carbide Saw Grinder



8' Lumber Stacker



ISELI Bandsaw Leveler



BUSS AUTOMATION 8' Tilt Hoist



MELLOTT 48" Rosserhead Debarker



CM&E Headrig Slabber



CUTLER HAMMER 200 HP Soft Start



PRECISION 40' Vibrating Conveyor



24" & 30" Cambios



Radial Stacking Belt

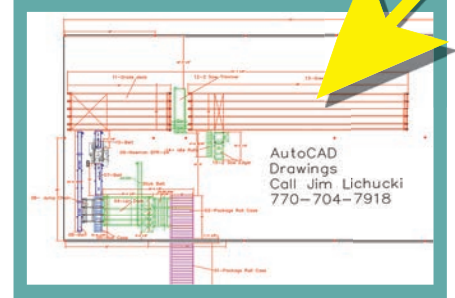

— AUTOCAD LAYOUTS —



(2) PRECISION 58" Chippers



FASTLINE 4 Head Resaw, 2"



FULGHUM 66" Chipper



HMC 2-Saw 20' Trimmer



MORGAN Post/Cant Trimmer

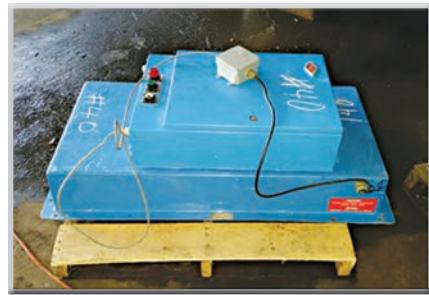

MDI Metal Detectors (New & Used)



Lots Of Waste Conveyors



ARMSTRONG Side Pro Grinder



ARASMITH Bark Hog



WILLIAMS Wood & Bark Hog



JEFFREY Hogs 55, 45 & 30 WB



WESTINGHOUSE 1600A Main Switch



PEERLESS 30 Unit Chip Bins, pair



TAYLOR 25,000 LB Forklift



PENDU M4000 Pallet Gang



40' Log Trough



Ben Jones Machinery

Div. of Dickert Enterprises, Inc.

Industry's Most Trusted Source



800-241-8983

Ken Dickert, President

Eric Doss 706-324-2604

Jim Lichucki 770-704-7918

sales@benjones.com



**** Financing Available ****

Pallet Recycling Solutions from Smetco...



Stringer/
Board
Splicer

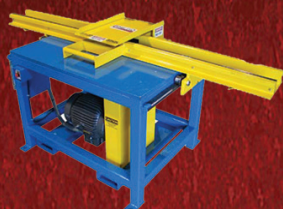

Notchers



Trim Saws



Turntables



"Quick-Stack" System



Stackers

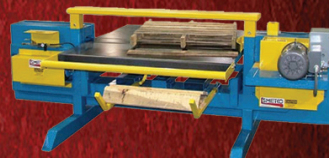

Dismantlers



Single End
Trim Saw

SMETCO also makes a complete line of repair and recycling equipment.



Sorting Systems

SMETCO, INC.
Pallet Handling Systems
PO BOX 560
AURORA OREGON 97002

Phone: 1-800-253-5400
Fax: 503-678-3095
www.smetco.com
sales@smetco.com



Attention Southeast Pallet Operations -

We offer Pallet Cut Stock delivered to your plant. Reasonable prices - Reliable delivery!

We also supply:

- Crating products
- Packaging products
- Treated Materials
- SYP Plywood, OSB
- SYP Lumber
- Particle Board, MDF
- Hardwood Lumber
- Import-Export wood products



Magnolia Forest Products, Inc.
P.O. Box 99 • Terry, MS 39170 • Fax: 601-878-2589

Call 800-366-6374
or 601-878-2581

Need Parts to Fit Your Morgan Saws?



Sawmill Supplies & Equipment, LLC
supplies parts and more!

- Board De-Dusters
- Multi-Head Trim Saws
- Military Band Groover/Notchers
- Product & Waste Conveyors

Tell us what you need.
We'll build it... the RIGHT way!

Office: 318-994-2116

www.sawmillsupplies.net

E-mail: sawmillsupplies@centurylink.net

Sarepta, LA

Sales:

Call Mona Tracy

1-855-298-8890 (toll free)

sales.universalmachinerysales@gmail.com

universalmachinerysales.net

Still Building the ORIGINAL
Low Profile Single Resaw

FOR SALE

- Hydraulic unit, 20 gallon pump, 35 gallon tank #1507
- 78 Chain Deck, 3-strand 10' long w/hyd. drive #1502
- Rollcase 15' long x 14" wide w/pillow block bearings #1504
- Skate Roll Deck, 20' long 2-strand w/ stops #1494
- Lumber transfer deck, 19' long 2-strand C55B rooftop chain #1495
- 10' long, 5" wide driven Roll-case w/ 2 driven top pinch rolls, air actuated #1496
- Lumber Transfer Deck, 26' long 2-strand C55B rooftop chain #1498
- Lumber Hoist / De-stacker, 4,000 lb capacity #1499
- (2) Pendu Model 2400 Cut-off Saws #1489 & #1512
- Cornell Model 642 Edger #1469
- 21' Long Belt Conveyor #1460A
- West Plains 4 Strand 2080 Chain Deck #1406
- West Plains Rollcase #1398 #1405
- Pendu Green Chain #1270
- Pendu Model 1600 3 Strand Green Chain #1027

For complete details call

800-233-0471

Email: info@pendu.com

www.pendu.com

PRECISION CUTSTOCK!

GOLDEN EAGLE GANG SAW SYSTEM

- Dust Free Lumber
- Single, Double or Twin Double Arbors
- Built-In Planer Sizer
- 8" to 25" Bay Widths
- As Thin as .125 Kerf in Double Arbors
- Variable Feed Rates

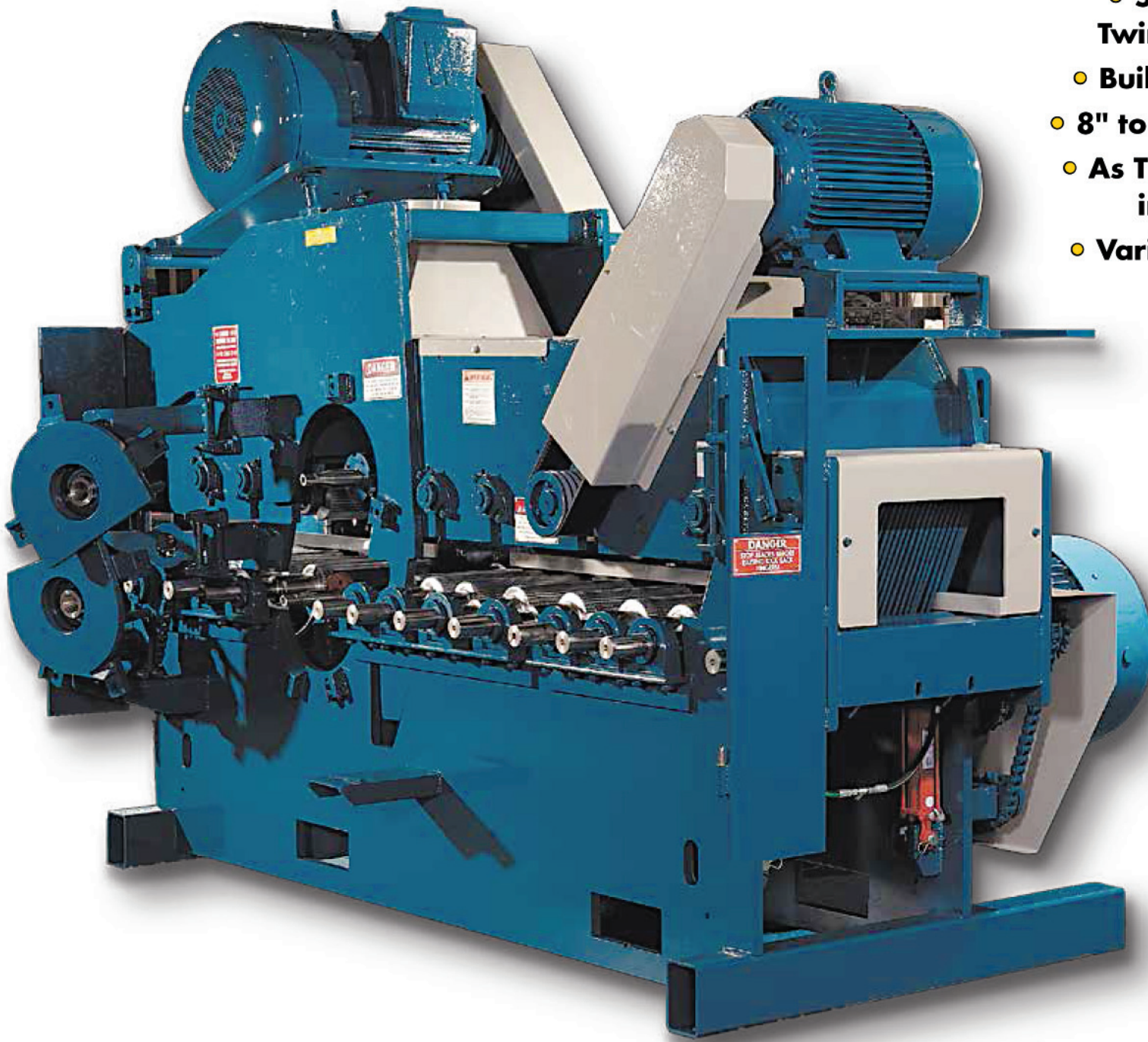

BREWER
MACHINE AND PARTS

800-345-6516
www.brewermach.com

FULL PRODUCT LINES FOR PALLET, STAVE, GRADE AND RAIL TIE INDUSTRIES.



Get Your Green Chain Rolling!

With "Roll-Top" Chain From Froedge

- Runs on standard sprockets for WR78 chain
- Reduces physical stress in pulling lumber
- Increases efficiency



Other Applications Include: Chain Transfer, Pull Decks, Pull Chain, Sort Chain, Inspection Chain, Grader's Chain & More!



888-868-5891
See in action @ www.lumberhandling.com
Tompkinsville, Kentucky

Here To Make It Work.
INDUSTRIAL SUPPLY, MACHINING, AUTOMATION,
MANUFACTURING AND REPAIR SINCE 1962.

WANTED TO BUY

- 3 Head Trio Dismantler
- #2 Pallet Lumber
- Line Bar Shims
- Hard Maple 4 x 6's, Special Pricing
- Cross Tie Siding
- 4 x 6 Cants

FOR SALE

- 40" Recycled Runners

Elora Pallet Shop Elora, TN
931-469-5558



FOR SALE!

Visionary Pop-Up

LEERAY & LUKE HORTON
218-372-4232
E-Mail: llsales@frontiernet.net

When You Buy Your Circular Saws From B.H. Payne – You've Bought The Best . . .

We Guarantee It!

Here's What You Get With EVERY B.H. Payne Saw –

- Saws manufactured from only the Highest Quality Nickel Alloy Steel
- Each Saw Milled With State-Of-The-Art Precision CNC Milling Machine
- We Tension Your Saw to Your RPM BEFORE Leaving Our Factory
- Complete Guarantee of Your Satisfaction

We Are Hanchett Distributors

We Manufacture & Sell Inserted Tooth Headsaws, Solid Tooth Saws, Inserted Tooth Cutoff Saws, Carbide Saws & Wide Band Saws. We Also Stock And Sell Bits & Shanks, Carbide Tips, Diamond Wheels, Knife Grinding Wheels, Saw Gumming Wheels, Knives, Babbitt & Babbitt Pots, "Lubie" Lubricants, Machine Parts for Various Filing Room Machines & More!

B.H. PAYNE & COMPANY, INC.

P.O. BOX 90608, East Point, GA 30364
404-761-8711 FAX 404-761-5398

"Traditional Quality Combined With Today's Technology"

Call 800-752-0627



Make Sure To Ask For Our Free, Complete Saw Catalog

www.paynesaws.com

NEW Low-Cost Phenolic Inserts

phe-no^l-lic: a class of chemical compounds consisting of a hydroxyl group bonded directly to an aromatic hydrocarbon group.

That just means your saws will run better with less friction using this sturdy, non-metallic material. Specially lubricated, longer lasting.

Find out more @ **800-685-2899**

Tri-Star Metals Inc.
"The Insert Guide Experts"



PRECISION-BALANCED HOG ROTORS

ELLISON SALES, INC.
Toll-Free: 888-244-0161
dan@ellisonsales.com

PRINTERS FOR THE PALLET INDUSTRY



444SM-PALLET PRINTER

- Cost-effective alternative for placement of HT, IPPC information on each and every pallet.
- Capable of mounting to automated pallet machines.
- Saves time and money compared to manually hand stamping or spraying information on pallets separately.
- Velcro backed hubs allow quick and easy changes to information placed on pallets.
- Spring tension maintains contact and even printing on every pallet.
- Fully adjustable.
- Permanent stamps and information.
- **7 different colors of ink and ink rolls available**

CLAUSSEN ALL-MARK INC.

8795 Grissom Pkwy. - Titusville, FL 32780
PHONE: 800-252-2736 FAX: 321-607-5071
Email: sales@claussenallmark.com • www.Claussenallmark.com

Low Profile Band Resawing

Raising the Bar – Lowering the Cost!

- ✿ - HUGE Labor Savers
- ✿ - Cant returned HANDS FREE to the operator
- ✿ - Simple, compact design – return is built into the machine, all as one unit
- ✿ - 24/7 Support & Service
- ✿ - Easier to operate & maintain
- ✿ - Most economical on the market!

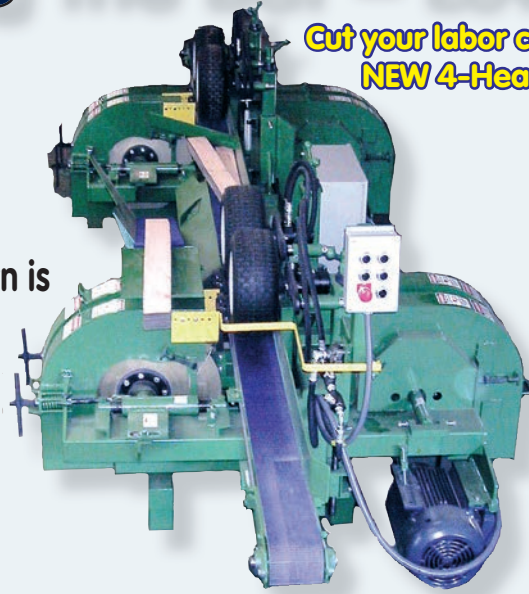

Cut your labor costs with our NEW 4-Head model.

Only 2 operators needed!

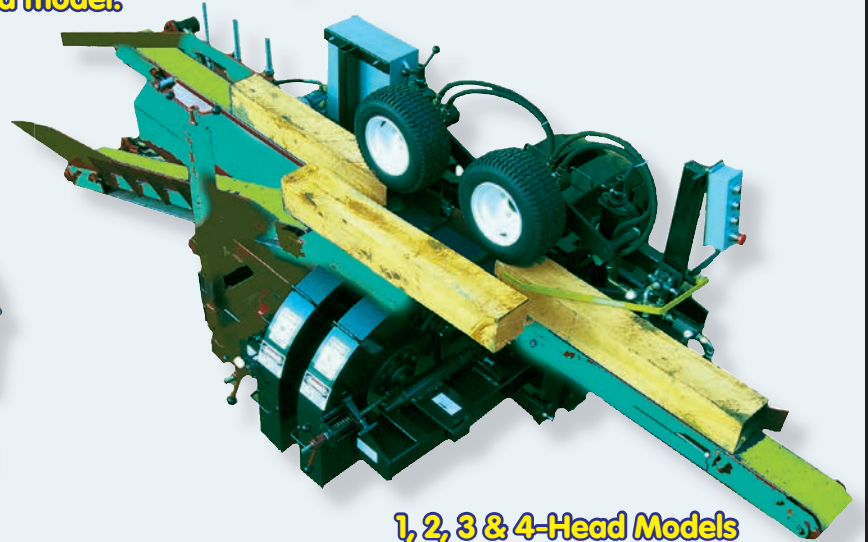

1, 2, 3 & 4-Head Models

Call the Multi-Head Resaws, LLC Team today to talk about your resawing needs.

GARY MORGAN
 1-318-847-4405 or
 cell 1-318-469-5077 (24 hrs)
 multiheadresaws@aol.com

Sales:
 Call Mona Tracy
 1-855-298-8890 (toll free)
 sales.universalmachineriesales@gmail.com

Need to Keep Your Current Equipment Running? Count on Brown...

During tough times, it's important to maintain the equipment you own, reduce your downtime and be more profitable.

Brown's Low Prices, First Quality Products & Superior Service can help!

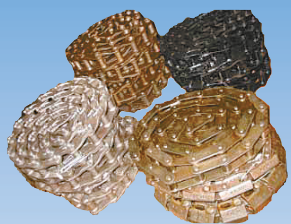

Chains (All Kinds)



Power Drive Units

New/Rebuilt Speed Reducers



Sprockets (Cast, Steel & UHMW Plastic)



Pillow Block/Flange Bearing Units



KEEPING YOUR OPERATION RUNNING SMOOTH FOR OVER 48 YEARS



800-748-9801

Fax: 870-246-8044

www.brownmachinery-supply.com

P.O. BOX 9, ARKADELPHIA, AR 71923 • info@brownmacsupply.com

OUR UNIQUE & INNOVATIVE WOOD DRYING PROCESS DELIVERS RESULTS



BRIGHTER LUMBER MEANS HIGHER SALES

Nova Dry Kiln's innovative technology offers a unique drying method that is kinder and gentler to the wood drying process. This process results in brighter lumber and gives our customers higher sales. Nova Dry Kiln builds and designs medium and large kilns ranging from 5,500 to 120,000 or more board feet.

TIMBER DRY MANAGEMENT CONTROLS OFFER FLEXIBILITY AND EASE OF USE

When using the Timber Dry Management System kiln operators have a straight forward, simple to use, flexible program. Kiln operators can make instant changes on the touch screen interface that is provided for each individual kiln. This drying control technology uses the exclusive proven and cost-saving Nova Dry Kiln methodology.

CONTACT US FOR FURTHER DETAILS

We provide turnkey construction services along with excellent customer service as part of our dry solutions. Call our technical staff today for further information about Nova Dry Kiln and our Timber Dry Management system.

INNOVATIVE TECHNOLOGY SAVES MONEY ON UTILITIES AND DEGRADE

Our kilns not only save money on utilities but our customers experience end results of only a 1 to 1 1/2% degrade. Using the combination of a thermal blanket created from our heated floors, with fans that do not reverse rewetting the lumber surface, also moisture is not reintroduced into the drying chamber for humidity control or conditioning, to the aluminum-lined walls that offer a superbly insulated chamber, the Nova Dry Kiln saves you money on your utilities and provides you with a superior end product and in most cases only a 1 to 1 1/2% degrade.



Ask about our Pallet Treating Kilns & Firewood Kilns

1-502-409-4539

www.novadrykiln.com • e-mail: info@novadrykiln.com



NEED IT NOW – AT THE RIGHT PRICE?

CALL LPS FOR NORTH AMERICA'S LARGEST INVENTORY OF SAWMILL, PALLET & WOOD MANUFACTURING EQUIPMENT



Ukiah Clam Shell
8x60 Thin Kerf



Nicholson A5B
Ring Debarker



8x20
Drum Dryer



Morbark Series 1000
Stac Trac



New
Lumber Unscrambler



Cresswood
Horiz. Slow Speed Grinder



Brewco B-800
2 Head Resaw



Salem 6' Air Strand Band
Head Rig Totally Rebuilt



Crosby Tie Trimmer
(Like New)



Fastline
Band Scragg



Stenner Resaw
with Runaround



Large Amount of
Motor Control Centers



6' CO-T Double Cut
Band Air Strand



Esterer
Optimizing Edger



40' Log Decks
(2) Available



Iseli
Band Saw Sharpener



Baker
12" Resaw



Tree Length
Step Feeder

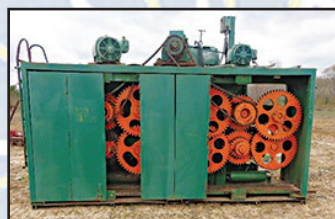

Nicholson A5 22" Ring
(2) Available



Log
Merchandising System



30"
Cambio



HMC AC40
Modular Mill



Complete HMC V206
Debarking System



Precision
3 Knife 48" Chip Pac



Ligna 9 Saw
Drop Saw Trimmer

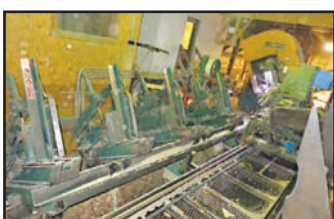

Sanborn Mini Max
w/4 H.B. Cleereman Carriage



Brewer
Gangsaw



Simonds
Band Saw Leveler



JCB 940
Forklift



Complete Pendu
Gangsaw System

LPS EQUIPMENT & ACQUISITION CO.

731-986-4351 • Email: sales@lps-inc.com

America's Largest Inventory!

800-598-3651 WWW.LPS-INC.COM

Pallet Assembly Solutions from Mona Tracy...

**Thinking About Buying A Nailing System?
Universal Gives You Choices...**

Block Pallet Attachment Available!

The "NAIL EASE"



Nailing pallets has never been easier!

- Assembles all size pallets (up to 50" x 50") with easy adjustments
- For New & Recycled lumber

The "REVO" Revolving Work Station



- Labor Saving!
- Nail at your own pace
- For New Pallets, Recycling or Reman jobs

STACK-MATE Automatic Stacker

- Adjustable capacity
- Stacks up to 20 pallets high



Fast, Easy Assembly of Any Size Pallets!



NAIL-MATE Automatic Nailing Jig

- Auto firing, one-man operation
- Handles 3 or 4-stringer pallets, wing pallets or others up to 50" by 50" at a rate of 1-2 pallets per minute!

The Nailing Station



- Hold down system and swivel turn over for nailing both sides
- Simple Construction of large, heavy & hard-to-handle sizes (any length possible)

JAM DOCTOR

- Clears Nail Jams!



The MORGAN Line-Up!

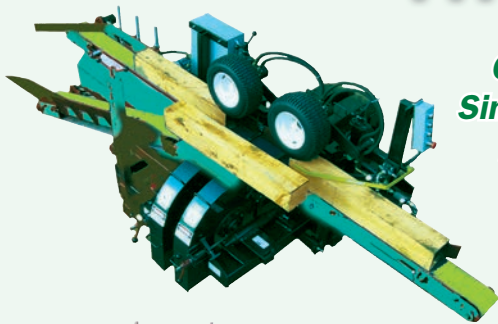

Original Single Head Resaw

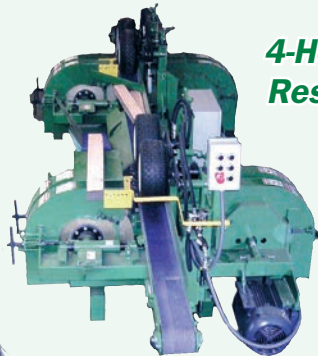

4-Head Resaw



Wide Cut Resaw



Military Band Notcher



Multi-Head Trim Saw

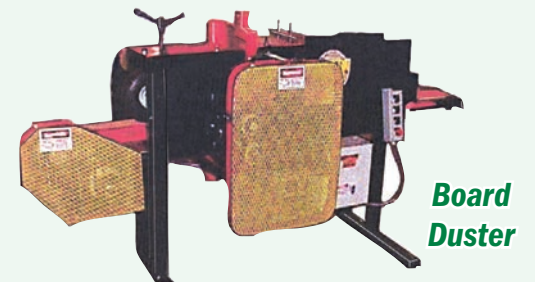

Board Duster



UNIVERSAL
MACHINERY SALES, INC.

Sales: Mona Tracy
Universal Machinery Sales, Inc.
1-855-298-8890

e-mail: sales.universalmachinerysales@gmail.com
www.universalmachinerysales.net

Parts/Service:
Sawmill Supplies & Equip. LLC
318-994-2116

e-mail: sawmillsupplies@centurylink.net
www.sawmillsupplies.net

Service:
Gary Morgan
318-469-5077
(24 hrs.)

Leasing & Financing Available



50 YEARS OF METAL DETECTION EXPERIENCE

SAVE ON COSTLY REPAIRS AND DOWNTIME!
You can't afford to have less than the best metal detector protection for your valuable equipment.

TWA-2000-HD



Fiberglass Sections



XR-3000 Series



MP-2000 Series



Phone: 541 345 7454
Fax: 541 345 7971
www.mdiblue.com

Metal Detectors, Inc.
Proudly made in the USA!

GOOD USED EQUIPMENT

- (2) **GO FAST** Dedusters
- **KENT** Single Head Notcher
- 2 Head End Trim Saw 60" Capacity

Call Today! **920-986-1145**



BIG JAKE Scragg
Ben Jones Machinery
Div. of Dickert Enterprises, Inc.
Industry's Most Trusted Source
800-241-8983
See more equipment at www.benjones.com

Crosscut Unit Saws
See in action at www.ptmi.net
Quick, Accurate Processing --- Low Labor!



SMALL EUROS WANTED
31.5 x 47.5 - Full & Half Loads
Ruma Pallet
617-455-1184
e-mail: pallets@rumas.com

Row Electrical Equipment, Inc.
P.O. Box 2812 • Toledo, Ohio 43606
Your Source for Used & Reconditioned:



- Squirrel Cage Motors
- Gear Motors
- Wound-Rotor Motors
- Synchronous Motors
- DC Motors
- Phase Converters
- Adjustable-Speed Drives

- Generators, AC and DC
- Engine-Generator Sets
- Transformers, Single Phase
- Transformers, Three-Phase
- Across/Line Starters
- Reduced Voltage Starters
- Safety Switches



24 Hours a Day Call **800-248-4479** • We Buy Used Electrical Equipment
Visit our website: www.rowelectrical.com • Email: rowelec@glasscity.net

THERE ARE MANY REASONS WHY YOU NEED TO KNOW WHAT YOUR MILL IS WORTH
EQUIPMENT & INSURANCE APPRAISALS • MARKETING PLANS • LENDERS
You have the right to choose your insurance appraiser!

See Our New Appraisal Website Today! www.kittrellappraisals.com
See Our New & Easy To Use Equipment Site! www.kittrellsawmillbrokers.com



KITTRELL APPRAISALS
Forestry Equipment and Consultation
931-698-3342

BE SURE YOU SPEAK WITH JACQUELINE KITTRELL,
OWNER, APPRAISER, AUCTIONEER, REAL ESTATE BROKER, CAGA



info@kittrellappraisals.com • Fax: 931-231-1051 • Office: 931-797-6284 • Firm #5745

USED EQUIPMENT

We own what we advertise!
New Equipment Arriving Weekly



866-546-8864
<http://pallet-repair.com/viewused.asp>

STRAIGHT TALK & SAWMILLS

That's What You Get at Sawmill Exchange!

OVER 800 LISTINGS!

Band or Circular Sawmills, Portable or Stationary, Manual or Auto, Hobbyist to Professional Models.

Plus, the Support Equipment to "Make Your Dream Mill a Reality."

Like Resaws, Edgers, Planers, Dry Kilns, Chippers, Loaders, Firewood Processors and More!

2005 Cooks AC-36 High Production Portable Sawmill and Edger Package With Under 150 TOTAL HOURS!!!



Located in Virginia
\$45,900

This High Production Package includes 62 HP Perkins Turbo Diesel Engine powering the sawmill, 36" x 20' log capacity, double-axle sawmill trailer w/very bright LED towing and brake lights, 25 HP portable Cooks 2-Saw gasoline Edger w/very bright LED towing and brake lights, Cooks Cat Claw Band Sharpener, Cooks Band Setter and Cooks Band Roller.

It all performs "as new" and you can come watch it saw!

Call Today to Sell Your Mill or Receive Current Inventory Listings! Or Go Online —

www.sawmillexchange.com

SAWMILL EXCHANGE

800-459-2148
713-729-6455 (713-SAWMILL) • Fax 205-453-4262

PHASE CONVERTERS

RUN 3-PHASE EQUIP. FROM SINGLE-PHASE POWER SOURCE

STATIC CONVERTER



STATIC:
2/3 RATED HP
MOTOR LOADS ONLY
1/3 TO 50 HP

OVER 45 YEARS EXPERIENCE IN PHASE CONVERTER SYSTEMS

RUN YOUR WHOLE SHOP!

CNC/PLC AVAILABLE FOR VOLTAGE SENSITIVE APPLICATIONS

ROTARY CONVERTER



ROTARY:
FULL RATED HP / OUTPUT
RESISTIVE & MOTOR LOADS
FRACTIONAL TO 500 HP OR MORE

CALL NOW! 1-800-962-6976 **PHASE-A-MATIC™** www.phase-a-matic.com



silverTIP[®]

CARBON BANDSAW BLADES

Profile Ground Tooth

TIP TO TIP

Wood-Mizer's SilverTip blade is a **TOP-PERFORMING**, economical blade for primary and secondary wood processing.

Smith Sawmill Service

800.598.6344

181 Co Rd 4763
Timpson, TX 75975

The Wood-Mizer quality you love. The convenience you need.

MAKE THE RIGHT CHOICE!

CHOOSE ASSOCIATED AUCTION



ASSOCIATED AUCTION
& Liquidation Co.

UPCOMING AUCTIONS

- ✓ August 22, 2015 10 AM ET
Worcester, NY
"Formerly Worcester Valley Lumber"
Complete Sawmill & Real Estate
- ✓ August 26, 2015 10 AM MT
Silver Plume, CO
Formerly New Earth Pellets
Complete Pellet Mill
- ✓ August 29, 2015 10 AM ET
Newland, NC
Pritchard Lumber
Complete Sawmill facility,
Rolling Stock & Land
- ✓ September 19, 2015 10 AM ET
West Union, OH
Wheat Ridge Pallet & Consignors

Put Our Track Record of...

- *Top Dollar for your Equipment, Real Estate & Rolling Stock*
- *Most Aggressive International Advertising Campaigns*
- *The MOST Online Bidders*
- *70 Years Combined Experience in Forest Industry Auctions & Equipment Liquidation*

To Work for YOU — Call Our Team of Professionals Now!

Associated Auction & Liq. Co.
PO Box 147 Clarksburg, TN 38324
800-598-3651 • Fax: 731-986-4529
Sales@associatedauctioncompany.com
www.associatedauctioncompany.com

Lumber News Since 1922

HARDWOOD MARKET REPORT

Memphis, TN 38088-2633
Telephone: 901-767-9126 ~ Fax: 901-767-7534
E-Mail: hmr@hmr.com • Website: www.hmr.com

Contact us or go online at hmr.com for a sample copy.

The acknowledged source for hardwood pricing



Actual Size Handheld Super-Size Performance

For Lumber, Logging, & Cruising, switch to the handheld that consistently out-performs all the others.

For more info and a risk-free demo call **888.520.1951**

Or go online at www.eLIMBS.com

CEMARLIGNE

NEED A LASER?

SEE PAGE 32...

CEMAR ELECTRO INC.
THE LEADER IN LINE LASER TECHNOLOGY

Make Plans Now to Attend the Kfia Regional Meeting

Hosted by Brewco, Inc. in Central City, KY
Wednesday, August 19, 2015
Golf Scramble, Social Hour and Meeting

- To be held at the Central City Country Club in Central City, KY
- Golf Registration: 10:30 to 11:25 am
- Tee-Off Time: 11:30 am
- Social Hour: 5 – 6 pm
- Dinner and Meeting: 6 pm
- Address (for all events):
• Central City Country Club
• 150 Country Club Drive
• Central City, KY 42330
- Cost(s):
 - Golf - \$65 per person
 - Dinner - \$35 per person

Golf: 4 person scramble, 18 holes, Shotgun Start. Fee includes golf, cart rental, 1 bag range balls.

Social Hour: Begins at 5 pm, bar will be open. This is the time to network and socialize with your friends.

Dinner and Meeting: Dinner begins at 6 pm, afterwards will be golf awards and the Regional Meeting.

For more info, contact Brewco at 800-237-6880 or Kfia at 502-695-3979 or visit www.kfia.org.

Need Parts to Fit Your Morgan Saws?

Sawmill Supplies & Equipment, LLC supplies parts and more!

Office: 318-994-2116
www.sawmillsupplies.net
E-mail: sawmillsupplies@centurylink.net

Still Building the ORIGINAL Low Profile Single Resaw

THINKING AUCTION?

Call: 800-432-1922

WAUSAU AUCTIONEERS
SALES CORP. P.O. BOX 1311 • WAUSAU, WI • 54402-1311
PH: (715) 536-1955 • (800) 432-1922

"Forest Products Specialists"

See For Yourself... **TIMBER WOLF** Band Mill Blades

A New Way to Buy your Blades at

timberwolfbandmillblades.com

STREAMLINE LASERS



OUR MOST POPULAR ELD-15

IS THE INDUSTRY STANDARD FOR LONG LIFE & DURABILITY

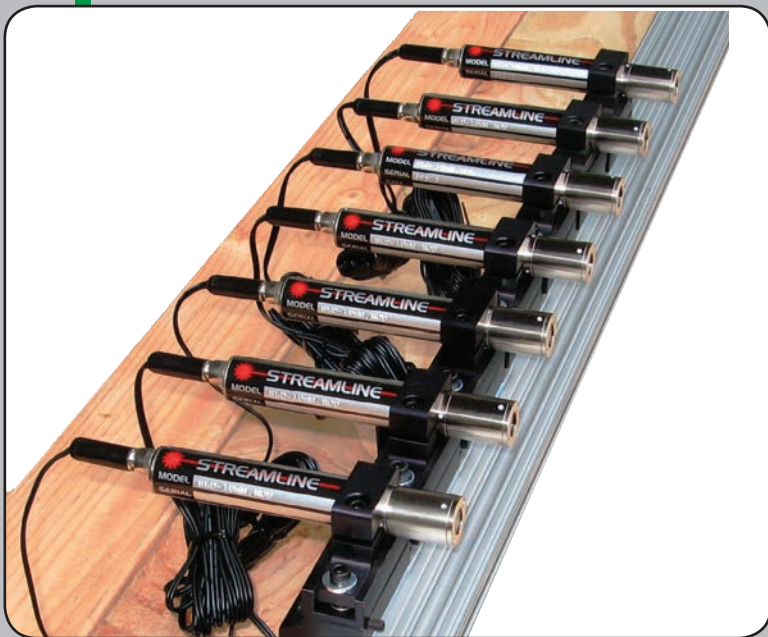

Get It All

- Cost Less Up Front!
- Longer Useful Life (*means it costs EVEN LESS!*)
- Superior Components
- Standard & Premium Grades Offered
- Straight Talk – we ONLY sell you the laser YOU NEED!
- Two Year Warranty on Most Lasers Sold
- Thinking **GREEN** Lasers? Call to Get the FACTS FIRST!

The EGL Has Landed... Again!
The New EGL Series of
Green Diode Lasers

- * *Economical*
- * *Precise*
- * *Enhanced Visibility*



Before you Buy ANY LASER –
For ANY Forest Industry Application
Call Ellison Sales FIRST!



Shift Kits Available for Moveable Saw Applications

The Laser Choice Since 1972 – Over 40 Years Of Laser Manufacturing and Straight Talk



ELLISON SALES
Toll-Free: 888-244-0161
E-mail: dan@ellisonsales.com
www.ellisonsales.com

Used & Reconditioned Equipment In Stock!



In Stock! Used/Reconditioned Baghouses, such as this Torit 276RF 12—complete with rotary airlock & support steel with capacities from 5,000 CFM to 70,000 CFM depending on requirements. We stock a wide variety of replacement parts for baghouses: filter bags, cleaning head blowers & components, level detectors, rotary airlock speed reducers & drive components.



Used/Reconditioned Fan Packages Material handling or air handling fan, motor, drives, base & electrical (if required); 4,000 CFM to 60,000 CFM capacities available; Reconditioned units receive new paint, bearings & thorough check up!



In Stock! A wide variety of used electrical control equipment including disconnects, magnetic starters, solid state soft starts, used spark detection/suppression panels, spark detection/suppression detectors & spray nozzles.



Used Woodworking Machinery, including Fletcher banders, CNC routers, saws, wood grinders/hogs, conveyors, etc.

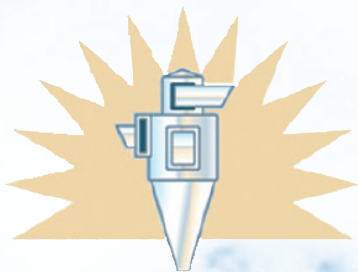

Air Systems Mfg.
OF LENOIR, INC.



Check out our website at:
www.airsystemsmfg.com

(828) 757-3500
Fax (828) 758-5178

2621 Hogan Dr.
P. O. Box 1736 • Lenoir, NC 28645

Over 12,000 Edgers Built And Still Going Strong

Meadows Mills' acquisition of Miner Edger means we have more edger building experience and more edgers in operation worldwide than anyone else. So trust your next edger investment to the real experts. We've been building better sawmill equipment since 1902!

6", 7" or 8"
Combination
Edgers

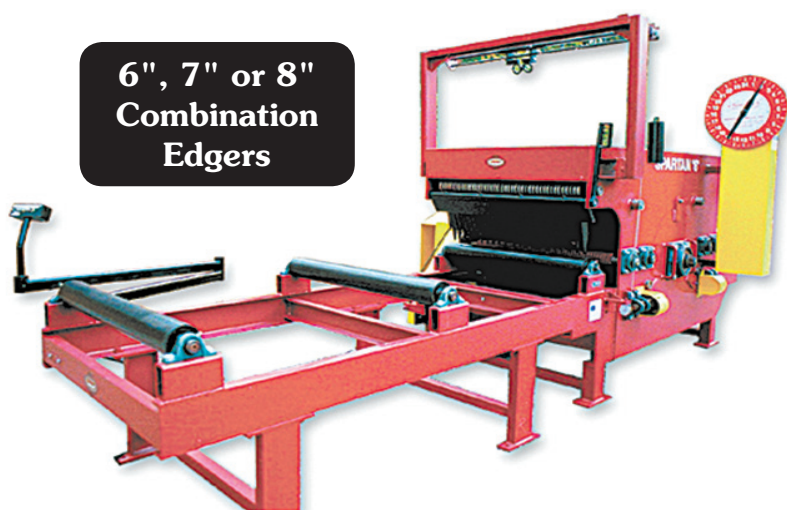

- Available with 6", 7", and 8 1/2" depth of cut
- Frame widths available in 36", 42", or 48"
- Solid steel side plates with door for easy saw changes
- Made in USA
- Call Meadows Mills and let us design a combination edger to improve your efficiency and profit!

MEADOWS MILLS, INC.
800-626-2282

www.meadowsmills.com • e-mail: sales@meadowsmills.com



See Our New Equipment Website
www.kittrellsawmillbrokers.com

Request Our Award-Winning Newsletter with Equipment listings, Wanted Equipment, Appraisal information...and much more
Join our network and get your copy today!



Call us today **(931) 797-6284** TO GAIN ACCESS

Bandsaw Blades!

Custom Welded – Immediate Shipment
Call for prices and sizes available.

LENOX

WOODMASTER

MORSE

&

KASCO
SharpTech

SHARPENING SERVICES NOW AVAILABLE FOR 1", 1 1/4", 1 1/2", 2" BANDS

W-37 Wright Grinder

A compact, automatic grinder that is quick to set up and simple to operate. Precision cams produce excellent sharpness.



4800 SOLVAY RD - JAMESVILLE, NY 13078

1-800-952-8288

WWW.U-CUT.COM

AUCTION



REAL ESTATE TO BE OFFERED FIRST

WORCESTER VALLEY LUMBER

9169 STATE HWY 7, WORCESTER, NY 12197

SATURDAY, AUGUST 22nd, 2015 9AM EST

TO BE OFFERED IN ITS ENTIRETY OR PIECEMEAL

- 15 ACRES OF COMMERCIAL INDUSTRIAL REAL ESTATE
- 24' x 40' HOUSE WITH 10' x 22' OFFICE
- 30' x 84' SAWMILL BUILDING 3 PHASE ELECTRIC
- 30' x 60' PLANER SHED
- 30' x 40' WOOD SHOP
- 30' x 40' BLOCK STORAGE
- 30' x 60' LUMBER STORAGE
- STEEL QUANSET LUMBER STORAGE 30' x 40'
- 15' 3 STRAND LOG DECK w/STOP & LOAD MOTOR & DRIVE
- HMC V206 H ROSSERHEAD DEBARKER FLAT TRACT CAB & CONTROLS S/N H01-78
- 50' CORNELL BARK CONVEYOR w/MOTOR & DRIVE
- 33' 3 STRAND LOG DECK w/STOP & LOAD MOTOR & DRIVE
- HMC CHAIN TYPE LOG TURNER
- 36" HMC 3H.B CARRIAGE 18' NEW HELLE TECH II SETWORKS
- NUMEROUS MOTORS, ELECTRICAL AND STARTERS

- 35' SAWDUST CONVEYOR MOTOR & DRIVE
- 57' CORNELL LIVE ROLLS 24' ROLLS MOTOR & DRIVE
- CORNELL 6" X 36" EDGER NEWLY RE BUILT, 1 SLIDING SAW, INFEED & OUTFEED S/N 638-12/79
- 12' 4 STRAND LUMBER DECK WITH C55D ROOFTOP CHAIN MOTOR & DRIVE
- 48" BUSH 3K CHIPPER S/N 71-12-14
- MELLOTT 21' VIBRATING CONVEYOR 19" BOTTOM MOTOR & DRIVE
- CORNELL 4' TO 16' DOUBLE END TRIMMER S/N 240-11-78 w/BLK CONVEYOR MOTOR & DRIVE
- 6' BELT CONVEYOR MOTOR & DRIVE
- 30' 4 STRAND GREEN CHAIN w/MOTOR & DRIVE
- 25 HP LEROI AIR COMPRESSOR
- CORNELL 10 HP SAWDUST BLOWER
- KOHLER GEN SET 85 KW KVA 106.25 127 AMPS 277/480V
- 8V71 DETROIT GEN SET 225 KW 460V w/TURBO
- 300 & 500 GALLON FUEL TANK
- BRIDGE WOOD 2002 4 SIDED MOULDER/ PLANER S/N 01A0209 8" X 6" MODEL CM 555
- (2) BELSAW PLANERS 5 HP MOTOR
- CKM 14" PLANER
- (3) CRAFTSMAN RADIAL ARM SAWS
- CRAFTSMAN TABLE SAW, BAND SAW & JIG SAW

- 6 CYLINDER BUDA POWER PLANT
- 6 CYLINDER CONTINENTAL POWER PLANT
- WITTY DRAG SAW
- 4000 BD FT DRY KILN w/NYLE CONTROLS
- CENTRAL BOILER OUTDOOR WOOD FURNACE MODEL CL5648 S/N 24839
- BOBCAT 225 WELDER GENERATOR
- VANTAGE 5000 GENERATOR
- RED ARROW HYDRAULIC PRESS
- DRIVE ALL METAL LATHE
- METAL BANK SAW
- SOUTH BEND METAL LATHE
- BEAM MACHINE
- BORING MACHINE
- SCREW TYPE LOG SPLITTER
- SKATE ROLLS
- MUD SUCKER PUMP
- CHIPPER KNIFE SHARPENER
- RESAW
- TWO MAN CHAIN SAW ANTIQUES
- TOO MUCH IN STORAGE TO LIST!!
- KILN DRY PINE
- PANELING DOUBLE SIDED 6' & 8'
- ROUGH HEMLOCK OF ALL SIZES
- HUDSON BANK MILL PORTABLE 6.5 HP MOTOR GAS RESAW FOR BEVEL SIDING
- (4) 40" STORAGE CONTAINERS
- 50' CHAIN CONVEYOR PORTABLE
- 30' CHAIN CONVEYOR PORTABLE
- CUB CADET LAWN MOWER
- HUSKEE 35 TON LOG SPLITTER

- CAT 922B WHEEL LOADER 1966 S/N 94A3754
- JOHN DEERE FORKLIFT 2010 1970
- HYSTER FORKLIFT 1968 YE-40
- 1962 TAYLOR FORKLIFT 15,000 LBS
- 1971 CASE 580 BACKHOE S/N 4197703
- 1971 CASE 580 BACKHOE S/N 4200486
- 1971 CASE 450 BULLDOZER 6 WAY BLADE 3052308
- 1970 MACK DUMP TRUCK S/N U685 13577
- 1975 DODGE DUMP TRUCK 10' BED
- ALLIS-CHAMBERS FORKLIFT 8000 LBS
- CASE SIZE C ANTIQUE TRACTOR 4 CYL. GAS ENGINE
- DC CASE TRACTOR
- FARM FOREST 7' BUSH HOG
- FORD DUMP TRUCK VIN# F60HCGA0089
- FORD 8N TRACTOR
- RAKE FOR TRACTOR
- WOOD/CHUCK CHIPPER CORP PORTABLE CHIPPER 36" CHIPPER 6 CYL. FORD INDUSTRIAL CHIPS 12" TREE
- FARM HAND GRINDER FOR MULCH WITH 4 CYL. DETROIT DIESEL MOTOR MOUNTED C/50 CHEVY TRUCK
- SHOP BUILT MULCH COLORING MACHINE
- GOOSENECK TRAILER WITH DOVETAIL
- SHOP BUILT PORTABLE COLORING MACHINE 4 CYL. CONTINENTAL MOTOR
- 8' DUMP BED



ACCEPTING CONSIGNMENTS!

LIVE ONLINE BIDDING proxibid

Bid Live Online via www.proxibid.com

Join Our Mailing List! Call or E-mail for Complete Brochure!

VISIT OUR WEBSITE
ASSOCIATEDAUCTIONCOMPANY.COM
FOR UPDATED INVENTORY LISTING

ASSOCIATED AUCTION & LIQUIDATION CO.
 PO Box 147 Clarksburg, TN 38324
 Fax: 731-986-4529
 sales@associatedauctioncompany.com
Toll Free: 800-598-3651

Tommy Ingram, Auctioneer
 TN Auctioneer License #3965, TN Firm #5524

TERMS: Full Payment day of Auction either by cash or cashier's check. Personal or Company checks will only be accepted when accompanied with an irrevocable verifiable bank letter of guarantee with statement of limit. Full payment must be made before leaving the sale location. Equipment sold "AS IS - WHERE IS" with no expressed or implied warranties. Sale Day Announcements will take precedence over any written material. 10% Buyers premium On Site, 13% Buyer Premium Online & Phone Bidders.



AUCTION

FORMERLY NEW EARTH PELLETS

120 Main Street, Silver Plume, CO 80476

WEDNESDAY, AUGUST 26th, 2015 • 10:00 AM MDT

TO BE OFFERED IN ITS ENTIRETY OR PIECEMEAL

** Lease Available on Property*

- RECONDITIONED BLISS 500HP PELLET MILL W/CONDITIONER, FEED & NEW 250HP HEAVY DUTY MOTORS – RAN 2 MONTHS
- MOISTURE ANALYZER
- COOLER
- CYCLONE FOR COOLER
- CONVEYORS & SCREWS
- SEVERAL BELT AND SCREW CONVEYORS
- 300 HP BLISS HAMMERMILL & MAIN FEED CONVEYOR
- LARGE CYCLONE & FAN FOR HAMMERMILL
- SMALL CYCLONE & FAN FOR HAMMERMILL

- 75" MORBARK WHOLE TREE CHIPPER W/300 HP MOTOR
- 40' WHOLE TREE 4-STRAND LOG DECK
- ROTEX SCREENER
- SPARE SCREENER
- RECONDITIONED CRUMBLER – NEVER INSTALLED
- CUSTOM AUTO BAGGER
- PALLET WRAPPER
- STAINLESS TWIN SCREW BIN
- (2) PELLET BINS
- (2) STORAGE CONTAINERS
- ELECTRICAL EQUIPMENT/VFD's/SOFT STARTS/MOTORS

- BRADEN SYSTEM
- LIVE BED BIN
- 3 CHIP BINS
- SEVERAL AUGER CONVEYORS W/DRIVES
- ELECTRICAL CONNECT INSIDE
- 950 CAT FRONT END LOADER W/FORKS & LOG GRAPPLE
- GEHL SKID LOADER
- IRON WORKER
- 6 x 6 TRUCK
- LARGE AMOUNT OF TOOLS AND PARTS
- REFINER



Accepting Consignments!

**VISIT OUR WEBSITE
WWW.ASSOCIATEDAUCTIONCOMPANY.COM
FOR UPDATED INVENTORY LISTING**



ASSOCIATED AUCTION & LIQUIDATION CO.
PO Box 147 • Clarksburg, TN 38324
Fax: 731-986-4529
sales@associatedauctioncompany.com
Toll Free: 800-598-3651
TOMMY INGRAM, AUCTIONEER

LIVE ONLINE BIDDING
Powered by proxibid
Bid Live Online via
www.proxibid.com

Join Our Mailing List!
Call or E-mail for Complete Brochure!

TERMS: Full Payment day of Auction either by cash or cashiers check. Personal or Company Checks will only be accepted when accompanied with an irrevocable verifiable bank letter of guarantee with statement of limit. Full payment must be made before leaving the sale location. Equipment sold "As Is - Where Is" with no expressed or implied warranties. Sale Day Announcements will take precedence over any written material. 10% Buyers Premium On Site, 13% Buyer Premium Online & Phone Bidders.

AUCTION

ASSOCIATED
AUCTION
& Liquidation Co.

PRITCHARD LUMBER

1551 Elk Park Highway, Newland, NC 28657
SATURDAY, AUGUST 29th, 2015 10AM EST

**Real Estate to be offered in its Entirety or Piecemeal • 12 Acres Commercial with Buildings Plus 800 FT of Road Frontage.
Edmiston Carriage, Modular Carriage, Precision 48" Chip Pac, John Deere 544 E Loader, Chip Trailers, Late Model Electrical**

- 20' 3 STRAND LOG DECK w/STOP & LOAD, MTR & DR
- PRECISION MDL 636H ROSSERHEAD DEBARKER w/CAB & CONTROLS S/N D-607 w/BARK CONVEYOR
- 25' PRECISION 3 STRAND LOG DECK w/STOP & LOAD NOSE SKID MTR & DR
- EDMISTON 42" 4 H.B. MODULAR MILL SIZE 40 MED S/N PBM801-E
- 4' X 4 1/2' CAB
- 50 HP EDMISTON HYDRAULIC UNIT
- 10' EDMISTON SLAB DROP BELT
- 150 HP RELIANCE MOTOR
- 32' EDMISTON LIVE ROLLCASE 24" ROLLS MTR & DR
- SPARE HEAD SAWS
- 8' 3 STRAND TRANSFER DECK MTR & DR
- EDMISTON 2 SAW HYD EDGER w/LAZER LIGHTS SIZE 4-30 w/40HP MTR TAILING BELT 32' S/N JF399F DATE 12-2-05
- 38' 3 STRAND LUMBER DECK C-55 D ROOFTOP CHAIN MTR & DR
- 5 HP T30 INGERSOLL-RAND TANK MOUNT AIR COMPRESSOR
- 10 HP BLOWER BEHIND MILL
- 70' BELT CONVEYOR 18" BELT MTR & DR
- PRECISION 48" CHIP PACK S/N C-376
- 75 HP MOTOR
- BANDING CARTS
- PRECISION 5 X 5 SHAKER SCREEN S/N S-969
- PHELPS DUAL CHUTE CHIP BLOWER 20 HP MTR
- CUTLER HAMMER STARTER BOX w/(3) SIZE 4 STARTER
- CUTLER HAMMER 800 AMP 600 V SAFETY SWITCH
- ALLEN BRADLY CENTERLINE MCC PANEL w/15 STARTERS
- WESTINGHOUSE 25 KVA TRANS FORMER
- GE STARTER BOX w/(3) SIZE 4 STARTERS
- JOHN DEERE 544E WHEEL LOADER S/N DWS44ED526627 HRS 12,795 w/LUMBER FORKS
- BUCKET FOR JD LOADER
- FORD 700 w/PRENTICE KNUCKLEBOOM w/DETROIT POWER UNIT 3 CYL.
- 1985 FREIGHTLINER DUMP TRUCK 14' BED CAB OVER VIN# 1FUEYSYB 3DP221243
- 1972 42' FRUHAUF CHIP VAN VIN# PP429702
- 42' STRICK CHIP VAN S/N NONE
- 1975 TRAILMOBILE 42' CHIP VAN VIN# N72419
- 35' 4 BUNK LOG TRAILER
- BRYCE 23' w/DOVE TAIL RAMP TRAILER 24,000 LBS VIN# 16JF01826K1020776



ACCEPTING CONSIGNMENTS!

LIVE ONLINE BIDDING
proxibid

**Bid Live Online via
www.proxibid.com**

**VISIT OUR WEBSITE
ASSOCIATEDAUCTIONCOMPANY.COM
FOR UPDATED INVENTORY LISTING**

**Join Our Mailing List! Call or E-mail for
Complete Brochure!**



**ASSOCIATED AUCTION
& LIQUIDATION CO.**
PO Box 147 Clarksburg, TN 38324
Fax: 731-986-4529
sales@associatedauctioncompany.com
Toll Free: 800-598-3651

Tommy Ingram NC Auctioneer License # 7330

TERMS: Full Payment day of Auction either by cash or cashiers check. Personal or Company checks will only be accepted when accompanied with an irrevocable verifiable bank letter of guarantee with statement of limit. Full payment must be made before leaving the sale location. Equipment sold "AS IS - WHERE IS" with no expressed or implied warranties. Sale Day Announcements will take precedence over any written material. 10% Buyers premium On Site, 13% Buyer Premium Online & Phone Bidders.



800-237-6880
www.brewcoinc.com

NEW B-1600 IN STOCK

READY FOR DELIVERY

CALL NOW!

Third Man Nailer



Call for FREE DVD
Jig & Stacker

Build Pallets Faster and For Less Money!

RT Pallet Equipment
306-737-3310
email: roberttrembley@hotmail.com
www.rtpalletequip.com

View the video on our website.



BOX 29 Imperial SK
SOG 2J0 Canada

TRI-STATE Auction & Realty, L.L.C.

Our Forestry Equipment Auctions

ATTAIN TOP DOLLAR!



TRI-STATE
Specializing In Forestry Equipment Auctions
And Certified Appraisals

• APPRAISALS • AUCTIONS • LIQUIDATIONS •



P.O. Box 567 • Kingston, Tennessee 37763
Phone (800) 334-4395 • Fax (865) 376-9103

• APPRAISALS • AUCTIONS • LIQUIDATIONS •

Morbark Demo Days

Coming August 20-21, 2015





Vendor displays, networking, food and entertainment — and, of course, live equipment demonstrations at our dedicated demonstration site — make Morbark's 2015 Demo Days the "must attend" event of the year!

During Demo Days, you will get to explore Morbark's manufacturing facilities and learn firsthand about the cutting-edge technologies, materials and processes used to manufacture our industrial equipment lines. In addition, we'll be offering educational and interactive experiences designed to help our customers learn more about our equipment and opportunities to expand their businesses.

We look forward to seeing you soon at our 2015 Demo Days!

Registration for Morbark's 2015 Demo Days is limited and will be filled on a first-come, first-served basis, so register today!



MORBARK

MORBARK HEADQUARTERS, WINN, MICHIGAN

For info, visit www.morbark.com or call 800-831-0042.

STILL THE FASTEST SWING SAW FOR MOST CUT-OFF OPERATIONS

FAST!

- Up to 72 Cuts Per Minute
- Greater Capacity & Easiest Operation
- 3 Models All w/Best Safety Features

The H & A Swing Saw

"Plants" Using OSHA Inspected & Approved



Call 1-800-397-3703

H & A Swing Saw Inc. • Since 1921

PO Box 127 • Lockridge, IA 52635

www.hasaws.com
email: hasaws10@lisco.com

Why Not Buy All Of Your Mill Supplies From A Single Reliable Source?



Did You Know That Smith Sawmill Service Is A Nationwide Authorized Dealer For SIMONDS and Armstrong Parts, Equipment and Supplies For Sawmills and Chip Mills?



That's right!
No more checking a map to find out who carries what products in your part of the country. Just simply make one call or send one e-mail to get whatever you need to keep your mill running... and running right!

Bandsaw Blades • Knives • Saws • Filing Room Equipment • And Lots More!

Check us out at www.smithsawmillservice.com or call 1-800-598-6344
e-mail: paul@smithsawmillservice.com



"SAWMILL SMART/ SAWMILL TOUGH!"

A-C-T® ACCURATE CHIPPING / CUTTING TECHNOLOGY



SFPA Announces 2014 Sawmill Safety Awards

Four Southern Pine sawmills – all members of the Southern Forest Products Association (SFPA) – are recent recipients of the 2014 Sawmill Safety Award. SFPA lumber manufacturer members are considered for the award based on information submitted regarding occupational injuries and illnesses. Safety performance is judged by how each mill's safety record stacks up against facilities with comparable lumber output throughout the year. Division I includes sawmills that produce 50 million board feet or less; Division II covers facilities that produce 51 to 150 million board feet; and Division III includes mills that produce more than 150 million board feet annually. The four sawmills being honored for outstanding safety records during 2014:

- Division I** Almond Brothers Lumber Co. – Coushatta, LA
- Division II** Weyerhaeuser Company – Holden, LA and Millport, AL
- Division III** Anthony Forest Products – Urbana, AR

"On behalf of all members, I want to commend these companies that excel at making safety in the workplace a priority," said SFPA Executive Director Tami Kessler.

The awards were presented recently at the opening ceremony of EXPO 2015 in Atlanta.

(Pictured, L-R):
 Tami Kessler, SFPA Executive Director;
 William Almond,
 Almond Brothers Lumber Company;
 Jim Krauseneck, Weyerhaeuser Company;
 Kerlin Drake, Anthony Forest Products;
 Scott Vande Linde, SFPA Board Chairman.



SFPA has represented manufacturers of Southern Pine lumber since 1915. Today, SFPA member companies produce about half of the nation's Southern Pine lumber. SFPA is headquartered in suburban New Orleans and can be reached at 504-443-4464 or by visiting www.sfpa.org.

CAE Twin Resaw

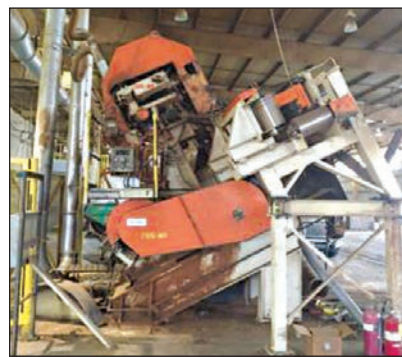

1-704-288-1904

Cat Wheel Loader



Caterpillar TT18 B Wheel Loader with Quick Attach. 4 WD, Good condition, 15,000 hrs total, rebuilt engine (2,500 hrs since rebuild). Forks & bucket included....\$29,500

• **110 HP 4045T John Deere Power Unit w/Clutch.** 2,500 hours, Good condition.....\$5,750

Call David: 618-244-1547

- Keystone Stacker
 - Nissan Forklift, 5000 Lb.
 - Smart S/H Notcher, New Cont.
 - (2) Tandem Campbell Nailers, Running till Sept.
 - (2) Campbell Pallet Stackers
 - (3) Keystone O/F Chains
 - Lead Board Remover, Model 123
 - Georgetown Hyd. Unit, 500 Gal.
 - Blower Pipe
 - Keystone Cut-off Rolls, 5' Outfeed, 10' Infeed
 - Band Aid
 - Hyd. Pumps, Misc.
 - Hyd. Cooler, 24"
- Call 717-535-5883**

STAKE POINTERS FOR SALE

Keystone Machinery Corp.
 Ephrata, Pennsylvania

717-859-4977

TRI-STATE AUCTION & REALTY, LLC

EQUIPMENT AUCTION

FAIRVIEW FOREST PRODUCTS

4438 US 68 ■ EWING, KENTUCKY 41039

SATURDAY • AUGUST 15, 2015 • 10:00 AM EST

Note: 10% onsite and 13% online Buyer's Premium added to the final bid price on all items. Live online bidding will be available at BidSpotter.comSM. All sales are final and buyer is responsible for removal of equipment. All announcements made on auction day take precedence over any/all written material. All buyers paying with a company or personal check must have a bank letter with statement of limits. We DO NOT accept credit/debit cards.

- FRICKCO MODULAR MILL
- LOADERS
- FORKLIFTS
- RESAWS
- POWER UNITS
- MOULDER

APPRAISALS • AUCTIONS • LIQUIDATIONS

APPRAISALS • AUCTIONS • LIQUIDATIONS

MILL:

- 10' x 16' Storage Bldg; w/Loft
- Frickco 4 HB Modular Mill w/Husk Frame; Off Bearing Belt; Pantograph; Trackway
- Edmiston 4' x 32" 2 Saw Edger w/2 Movable Saws; Hyd. Set; Infeed Rollcase; Outfeed Belt; 2 Line Laser Light
- Reckart 26" Suction Blower
- 48" x 5' Transfer Chain w/Drags; Hyd. Mtr
- 28" x 10' Belt Conveyor w/Hyd. Drive
- 28" x 20' Rollcase w/Hyd. Drive
- Gator 128 Fastline Single Head Resaw w/Lumber Return; Hyd. Mtr; Controls
- Brewco Speed Cut Chop Saw w/Hyd. Mtr; Controls; 10' of Gravity Rolls
- (4) 56" Circle Saws
- Wood-Mizer 18" x 6' Rollcase w/Pop Up Transfer; 4' 3 Strand Transfer; Hyd. Drive
- Hyd. Operated Chop Saw w/27' Gravity Rolls
- 4' x 34' 2 Strand Green Chain w/C55B Rooftop Chain; Hyd. Drive
- Mellott 18' 3 Strand Log Deck w/3 Arm Stop & Loader; Nose Skids; Hyd. Drive
- Frickco Chain Type Log Turner w/Controls
- Tru-Cut 8" Single Head Resaw w/Lumber Return; Hyd. Mtr

- Tru-Cut Gang Saw w/Hyd. Mtr; 1 1/2" Spindle
- Clipless Bander Polychem B800 Bander
- Reckart 26" Suction Blower w/Pipe; Hyd. Mtr
- 4' x 10' Cyclone
- (4) Lumber Rollouts



Gator Fast Line Resaw

- Holz-Krieger Profit 5 5 Head Moulder w/Hyd. & Electric Mtr
- Whirlwind Air Operated Pop up Chop Saw w/Hyd. Mtr
- Tru Cut Chop Saw w/Hyd. Mtr
- (2) Kobalt 10 HP Upright Tank Mounted Air Compressor
- (2) 60 Gallon Single Phase Air Compressors
- Miller Trailblazer 22G Gas Welder Generator w/Torch Hose; Gauges; Trailer Mtd
- Northstar 10,000 Watt Belt Driven Generator
- Northstar 7700 Generator
- Honda 5000 Generator
- Napa 6/12 Volt Battery Charger
- (30) Concrete Retainer Blocks
- (4) 2 1/4 Yard Self Dumping Hoppers
- (1) 3 Yard Self Dumping Hopper
- (24) Lumber Rollouts
- 12000 4' Hardwood Stacking Sticks
- (2) Jockey Grinders
- Front Line 24" Suction Blower
- (2) Hyd. Pumps, (1) for Carriage Drive; (1) for Resaw; Log Turner
- 100, 500 & 750 Gallon Hyd. Tanks
- 350 Gallon Hyd. Tank w/Hyd. Pump
- Hyd. Tank & Pump
- 5000 BF of 1" Air Dried Yellow Pine
- Ferris 13 HP Walk Behind Mower

- FSI Jet Talley Lumber or Log
- Reckart 42" Suction Blower w/Pipe; Hyd. Mtrs
- (2) Dewalt Miter Saws
- Gas Stove & Refrigerator
- 8' x 25' Cyclone w/Pipe
- 8" x 40' Waste Conveyor, No Drive; NI
- 3' x 16' Belt Transfer w/Hyd. Drive; NI
- 3' x 6' Belt Transfer w/Hyd. Drive; NI

POWER UNITS:

- Deutz 300 HP Power Unit w/PTO; Quincy Air Compressor; Northstar 5500 Belt Driven Generator; 12,145 Hrs; Hyd. Mtrs & Pumps
- Kubota 99 HP 4 Cyl. Power Unit w/PTO; 5100 Hrs; Hyd. Pump
- Deutz 4 Cyl. 50 HP Power Unit w/PTO; Generator; 4200 Hrs
- John Deere 175 HP Power Unit w/PTO; 2,540 Hrs
- Detroit 671 Power Unit w/PTO



Holz-Krieger Profit 5 Moulder

ROLLING STOCK:

- 2013 Kawasaki 45ZV Loader; w/Universal Exchange Quick Attach; 700 Hrs; Forks & Bucket
- 2003 Cat 924G Loader w/Quick Attach Bucket & Forks; Encl. Cab w/Heat & Air; 14,000 Hrs
- 2005 Prentice 280 KB Loader w/Joy Stick Controls; Continuous Grapple; CTR 450 Delimber; Cummins 6 Cyl. Eng; Saw Package Hookup; 3400 Hrs; Mtd on Pitts T/A Trailer
- 1991 John Deere 540D Cable Skidder w/H/D Winch; Newly Rebuilt Engine



2013 Kawasaki 45ZV, 700 hrs.

- Barko 160D KB Loader w/Joy Stick Controls; Continuous Grapple; Cummins Eng; Saw Package Hookup; CTR Delimber; 4300 Hrs; Mtd on Pitts T/A Trailer
- CTR 421P Reversible Frame Saw Buck
- 2010 Nissan Model 60, 6,000 LB Forklift w/3 Stage Mast; Propane Gas Eng; 7600 Hrs
- Mitsubishi 5000 LB Warehouse Forklift w/Propane Gas Eng; Side Shift; 3 Stage Mast
- 2013 Cat 2P5000 Forklift; 5000 LB; w/Dual Fuel Propane; Side Shift w/3200 Hrs
- Extra 96" Bucket for Bobcat
- Set of 42" Forks
- 1981 Fontaine 53' Drop Deck Flatbed



JD 540D Cable Skidder



Frickco Modular Mill



Check website for complete listing & additional photos
www.tristate-auction.com

KY LIC. #7048

Terms: Cash, cashiers check, all personal or company check must have bank letter of guaranty. Complete payment is due day of auction. Sold As Is, Where Is. No Warranty or Guarantee is Expressed or Implied. Announcement made day of auction will take precedence over any written material.

TRI-STATE

CERTIFIED INDUSTRIAL APPRAISERS

JOHN C. KIMBEL, JR.

TRI-STATE AUCTION & REALTY, LLC

P.O. Box 567 • Kingston, TN 37763

TOLL FREE 800-334-4395 or
 865-376-7009 Fax: 865-376-9103

E-MAIL auctions@tristate-auction.com

Visit Our Web Site www.tristate-auction.com

TRI-STATE AUCTION & REALTY, LLC

EQUIPMENT AUCTION

**FLY TIMBER CO., INC.
OAKLAND MILL SITE LIQUIDATION**

30016 HWY 32 ■ OAKLAND, MS 38948

SATURDAY • AUGUST 22, 2015 • 10:00 AM CST

NOTE: AUCTION WILL NOT AFFECT ANY ONGOING OPERATIONS OF FLY TIMBER, CO., INC. There will be a 10% onsite and 13% online Buyers Premium added to the final bid price on all items. Live online bidding will be available at BidSpotter.com. All equipment will be sold onsite by photos.

- **ROTOCHOPPER EC256**
- **(2) HURDLE MILLS**
- **(2) BREWCO B1600 RESAWS**
- **CUTTERS**
- **SKIDDERS**
- **LOADERS**
- **TRUCKS**
- **TRAILERS**

APPRAISALS • AUCTIONS • LIQUIDATIONS

APPRAISALS • AUCTIONS • LIQUIDATIONS

GRINDER, COLORING SYS, & BAGGING SYSTEM:

- 2003 Rotochopper EC256 Electric Wood Grinding Sys; S/N-03-2053; 12 Ton
- 2002 Rotochopper Go Bagger Sys; S/N-02-5007
- Sealer Bagger System
- Waufltec Model WHP200 Wrapping Sys
- Ameri-Mulch Mini Mate Mulch Coloring Machine

MILL:

- Precision P742H Rosser Head Debarker; S/N-D591
- Precision 55' Barn Sweep Conv.
- Mellott 90' Endwise Log Conv.
- Mellott H/D 3 Std 18' Log Deck
- 65' Waste Conv; w/#78 Chain
- 25' & 50' Barn Sweep Conv.
- 2003 Hurdle H/D 55C Challenger 3 H/B Tong Dog Carriage Portable Mill
- Winston 24" x 48' Tie Sorting Rollcase
- Precision HD 24" x 32' Vib
- 2003 Precision 58" 6 Knife Chip Pack; w/6 x 6 Screen
- Phelps 10 HP S/T Loading Sys
- WH 2100 Series MCC
- 2003 Brewco B1600 Grade Resaw; S/N-BBJ0348
- Phelps 36" Dust System

- 2005 L-M VPC20-HM Package Saw Sys; S/N-53605
- Woodland Portable Mill
- Fulghum 60" 6K Chipper
- Precision 18" x 21' Vib Conv



(2) Brewco B1600 Resaws

- Miner 2 Saw Edger
- Lots of Air Compressors
- 2001 Brewco B1600 Grade Resaw; S/N-BBL0117
- Winston 20" x 20' Outfeed
- Band Saw Sharpener & Setter
- 1981 Weinig 6 Head Moulder
- 2006 Weinig 5 Head Moulder
- 2006 Northtech MRS-12 Multiple Gang Rip Saw
- Diehl Straight Line Rip Saw
- Northtech Single Head Planer
- (2) Northtech Dual Bag Dust Sys; 5 HP
- Williams & Hudson Moulder
- Reeves 40 HP Suction Blower; w/Pipe; S/N-5886

GRADE SYSTEM:

- 55' 3 Strand Grading Deck
- Cornell 3 Strd Unscrambler
- Morgan H/D 3 Strd Pkg Deck
- (8) All Steel Lbr Rollouts

#2 GRADING LINE:

- 60' 3 Strand Collector Deck
- Winston Mach. 4 Strand Unscrambler
- (3) A/S Lumber Rollouts
- Thurman 60' 120,000 LB Above Ground Scale

EQUIPMENT NOT INSTALLED:

- Hurdle 2 H/B Portable Mill
- Miner 2 Saw Edger
- Precision 8 x 8, 6x6 & (2) 5x5 Chip Screens
- Kockums 66" 6K Chipper
- Cornell 6" Comb Gang Edger
- Miscellaneous Parts & Tools

CUTTER & SKIDDERS:

- 2010 John Deere 843K Cutter
- 2012 John Deere 748H D/A Skidder
- 2010 John Deere 648H Skidder; D/A
- 2008 John Deere 648H Skidder; S/A
- 2004 John Deere 548GIII Skidder
- (8) New Primex Skidder Tires

DOZERS:

- 2008 Komatsu D61EX-15E0
- 2004 Komatsu D65 Dozer
- 1998 Komatsu D155-AX Dozer
- V Blade for Case 1850 Dozer

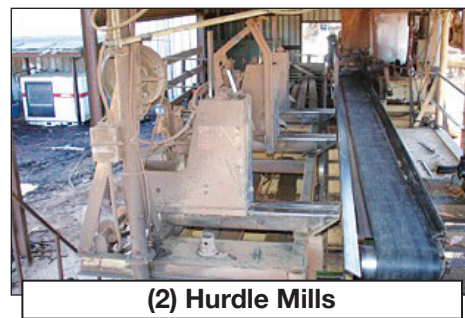

(2) Hurdle Mills

LOADERS:

- 2010 John Deere 437D KB
- 2003 Prentice 410E KB
- '02 Prentice 410E KB
- '99 Prentice 410E; S/N-54996
- '99 Prentice 410EX; S/N-54858
- 1997 Barko 160C KB Loader
- 1996 Prentice 210E KB Loader
- 2012 John Deere 644K Wheel Loader
- '98 John Deere 644H Art Wheel Loader
- John Deere 624H Wheel Loader
- John Deere 544J Wheel Loader



2006 Weinig Moulder

- '04 Volvo L110E Art. Wheel Loader
- H/Tilt Bucket for Volvo L110E
- (3) Case 1845C Skid Loaders
- Mitsubishi FD25N Forklift
- Komatsu D20T-16 Forklift
- Hyster Model H60FT Forklift

TRUCKS & TRAILERS:

- 2012 Kenworth T800 Road Tractor
- (2) 2010 Pete 389 Road Tractors
- (2) 2006 Pete 389 Road Tractors
- (3) '07 Freightliner Road Tractors; "Classic XL"
- 2008 Pete 388 Road Tractor
- 2006 Kenworth W900L Day Cab
- (2) Mack CHN613 D/C Road Tractors
- 1994 Western Star Road Tractor
- 2005 Ford F750 Service Truck
- 2005 Ford F550 Service Truck
- '96 Trail King 48' T/A Trailer
- '97 Pitts LT40 D/B Log Trailer
- (2) Pitts LT42-8L Log Double Bunk Trailers
- Stouton 45' Chip Trailer
- Aztec 53' Drop Deck Trailer
- Transcraft 48' Drop Deck
- Fruehauf 35 Ton Lowboy
- Kodiak 40' 4 Bunk Log Trailer
- (16) New Synergy 11R24.5
- (16) New Synergy 11R22.5



Mulch Coloring System

JOHN C. KIMBEL, JR.
TRI-STATE
AUCTION & REALTY, LLC

P.O. Box 567 • Kingston, TN 37763
TOLL FREE 800-334-4395 or
865-376-7009 Fax: 865-376-9103
E-MAIL auctions@tristate-auction.com
Visit Our Web Site www.tristate-auction.com

Check website for complete listing & additional photos
www.tristate-auction.com



MS Firm LIC. #447F

Terms: Cash, cashiers check, all personal or company check must have bank letter of guaranty. Complete payment is due day of auction. Sold As Is, Where Is. No Warranty or Guarantee is Expressed or Implied. Announcement made day of auction will take precedence over any written material.

TRI-STATE

CERTIFIED INDUSTRIAL APPRAISERS

TRI-STATE AUCTION & REALTY, LLC

EQUIPMENT AUCTION

SURPLUS EQUIPMENT TO THE CONTINUED OPERATION OF C & J MULCH, INC.

4614 AMY LYNN DR ■ NASHVILLE, TENNESSEE 37209

Directions: From Briley Parkway, take Exit 24, TN Hwy 12 toward Ashland City and go North ¼ mile and turn left on Amy Lynn Dr., bear right to stay on Amy Lynn Dr, go ¼ mile and auction site is on the right.

SATURDAY • AUGUST 29, 2015 • 10:00 AM CST

Note: There will be a 10% onsite and 13% online Buyers Premium added to the final bid price on all items. Live online bidding will be available at BidSpotter.com. All sales are final and buyer is responsible for removal of equipment. All announcement made on auction day take precedence over any/all written material. All buyers paying with a company or personal check must have a bank letter with statement of limits. We DO NOT accept credit/debit cards.

- WHEEL LOADERS
- GRINDERS
- COLORING MACHINE
- TRUCKS
- TRAILERS

APPRAISALS • AUCTIONS • LIQUIDATIONS

APPRAISALS • AUCTIONS • LIQUIDATIONS

WHEEL LOADERS:

- 2000 John Deere 544H Wheel Loader; S/N-574705
- 1998 John Deere 544H Wheel Loader; S/N-DW544HX566084
- Bucket for JD 544H Wheel Loaders
- 2002 Kawasaki 65ZV Wheel Loader; w/Forks & Bucket
- 1989 Kawasaki 65ZII Wheel Loader; w/Bucket
- 1988 Cat 936E Articulating Wheel Loader; w/Bucket
- 1994 John Deere 544G Wheel Loader; w/Lumber Forks; S/N-548583
- Slip On Bucket
- 1993 John Deere 544G Wheel Loader; w/Forks & Bucket; S/N-540668
- 1989 John Deere 344E Wheel Loader; w/Bucket; S/N-000176
- 2000 JCB 407B Wheel Loader; w/Quick Attach; w/Forks & Bucket; S/N-SL-P407ALYE0756617
- John Deere 317 Skid Loader; w/Forks & (2) Buckets

GRINDERS & COLORING MACHINE:



John Deere 544H

- Dura Tech HD-10 Portable Grinder; S/N-18-2-F1-0429
- Wood N Colors Mulch Coloring Machine; Model 90250-EZ; w/Belt Conveyor
- Precision Husky Pro Grind 4000 Portable Grinder; S/N-PG-159; w/Cat Engine
- Peterson 5400 Grinder; V-12 Cat Power; w/New Clutch



Peterson Pacific 5400

- Peterson Pacific Horizontal Grinder; Model 5400; S/N-19-63-890; Fire Damage

TRUCKS & TRAILERS:

- 2006 Peterbilt 379 Day Cab Road Tractor; w/Cummins ISX Engine; w/18 Speed Transmission; w/Wet Line Kit; w/Air Ridge; w/11R24.5 Tires on Aluminum Budd Wheels; w/Jake Brake; Odometer Reading 635,717; Unit 24; VIN-1XP5DB9X06N862201
- 2003 Peterbilt 379 Day Cab Road Tractor; w/Cat 475 Engine; w/10 Speed Transmission; w/Jake Brake; w/Wet Line Kit; w/11R24.5 Rubber on Aluminum Budd Wheels; VIN-1XP5D-B9X73N591486

- 1999 Peterbilt 378 Day Cab Road Tractor; w/Cummins Engine; w/9 Speed Transmission; w/11R24.5 Rubber on Aluminum Budd Wheels; w/Air Ride; w/Jake Brake; Over 1 Million Miles; VIN-1XPFD69X2XN491278
- 2003 Western Star Day Cab Road Tractor; w/Cat C15 475 HP Engine; w/10 Speed Transmission; w/Tuf-Trac Suspension; w/11R24.5 Rubber on Aluminum Budd Wheels; w/Jake Brake; Wet Line Kit; VIN-SK55ABAY93PK89028
- 1993 Mack Log Truck; w/Log Bunks; w/350 Mack Engine; w/9 Speed Transmission; w/44K Rears; w/11R24 Rubber; w/Pup Trailer Hitch; VIN-2M2P-267C7PC013595
- 2002 GMC Yukon Denali; w/All-Wheel Drive; w/6.0L V8 Gas Engine; Odometer Reading 170,000; VIN-1GKEK63U42J313796
- 1996 Ford F-450 Super Duty 2WD Service Truck; w/Turbo Diesel Engine; w/Manual Transmission; w/INT Crane 3016; w/Air Compressor; VIN-1FDLF47FXTEB00817
- 1994 Chevy 1500 Pickup; w/2WD; w/5.7L V8 Gas Engine VIN-1GCEC14K-XRE235472



(5) Peerless Walking Floor Trailers

- 2009 Peerless 45' Open Top Trailer; "Like New"; VIN-1PLE045239PE56671
- (5) Peerless 45' Walking Floor Trailers
- (3) ITI 42' Open Top Trailers
- 1981 Great Dane 42' Open Top Trailer
- Crescent 42' Open Top Chip Trailer
- Nabors 42' Open Top Chip Trailer

MISCELLANEOUS EQUIPMENT:

- New Helle 4 Strand Unscrambler w/Hydraulic Drive
- Lots of Empty Plastic Containers
- Water Pumps
- Wheel Dolly



2009 Peerless Open Top

JOHN C. KIMBEL, JR.
TRI-STATE
AUCTION & REALTY, LLC

P.O. Box 567 • Kingston, TN 37763
TOLL FREE 800-334-4395 or
865-376-7009 Fax: 865-376-9103
E-MAIL auctions@tristate-auction.com
Visit Our Web Site www.tristate-auction.com

Check website for complete listing & additional photos
www.tristate-auction.com

BidSpotter.com
Live Interactive Auction Website!
TN FIRM LIC. #1129

Terms: Cash, cashiers check, all personal or company check must have bank letter of guaranty. Complete payment is due day of auction. Sold As Is, Where Is. No Warranty or Guarantee is Expressed or Implied. Announcement made day of auction will take precedence over any written material.

TRI-STATE

CERTIFIED INDUSTRIAL APPRAISERS

2005 Cooks AC-36 High Production Portable Sawmill & Edger Package with under 150 TOTAL HOURS!!!



\$45,900

SAWMILL EXCHANGE
800-459-2148
www.sawmillexchange.com



COOPER Scragg



Ben Jones Machinery
 Div. of Dickert Enterprises, Inc.
 Industry's Most Trusted Source
800-241-8983
 See more equipment at
www.benjones.com



WE REBUILD MONTGOMERY HOG ROTOR ASSEMBLIES

ELLISON SALES, INC.
 Toll-Free: 888-244-0161
dan@ellisonsales.com

Selling at Auction
 Nashville, TN - August 29th



(5) Peerless Walking Floor Trailers

See ad in this issue or call
1-800-334-4395 or visit
www.tristate-auction.com for more info.

DON'T BE FOOLED BY IMITATIONS

Get your Genuine Woodpecker Nailing Machine Exclusively from

VIPER INDUSTRIAL PRODUCTS



WOODPECKER
 Up to 1200 pallets a day with two men.

Viper is the *exclusive* distributor of Stutzman Mfg. LTD, the *ONLY* manufacturer of Woodpecker and Woodpecker Junior nailing machines.



WOODPECKER JR.
 Up to 500+ pallets a day with a single man.



(217) 621-2133 or (501) 679-6814
Viper-dwagner@alliancecable.net



THE LOG STREET JOURNAL

"Your trusted authority for sawlog marketing information"

We Specialize In Current Log Prices!

Hard & Softwood Log Prices
 Log Prices For New England, NY & PA
 Veneer Logs | Grade Logs | Pallet Logs

www.TheLogStreet.com

Celebrating 25 YEARS! 1989 - 2014



The Log Street Journal | P.O. Box 5 | Whitefield | New Hampshire 03598 | 603-837-1101 | sawlogs@outlook.com

Simonds Saws Are The Best!

For over 180 years Simonds has thrived in the saw business by manufacturing the best saws in the industry.

Simonds Trademark Series Inserted Tooth Saws are produced using Nickel Alloy plate that is processed in our new heat treat facility. Our new on-site heat treatment is producing plates with a consistent hardness and uniform flatness that is not available from 3rd party plate suppliers. Simonds' saws keep maintenance costs down, maximize saw run time and add profit to your bottom line.

The Trademark Series Saw features:

- Finest Quality Nickel Alloy plate manufactured in Big Rapids, MI.
- Precision Laser Cutting and CNC milling
- Computer-controlled spin tester checks for vibration and run out

We have the most experience in the business manufacturing saws. We make the best — And now they just got better!

Simonds new saw plate heat treat facility enables us to deliver the flattest and toughest saws in the business!



The Professionals' Edge™

800-426-6226 | sales@simondsint.com | www.simondsinternational.com

Scan this QR code for additional information on our website.



American Lumber & Pallet — Digital Edition —

Loaded with Pages and Pages of New & Used Equipment and More!



The **NEW** amlumber.com

The latest, easiest and most affordable way to buy or sell used equipment...

For just one item to an entire yard of inventory — Check it out TODAY! —

[www.amlumber.com!](http://www.amlumber.com)



2015 KENTUCKY WOOD EXPO

September 18 & 19, 2015
MASTERSON STATION PARK
Lexington, KY

Featuring the Latest Technology & Services for: Sawmill, Pallet, Logging, & Secondary Equipment, Loaders, Chain saws, Trucks, Parts, Accessories, New & Used Equipment, and Much More!

Tickets: Adults (13 years old+) - \$7 at gate; **Kids** (12-6)- \$5; **6 & under** - Free
Free Parking

Events:

- Live Demonstrations of Machinery & Equipment— Inside & Outside Exhibits
- Wood Working Demonstrations
- Lumberjack Contests
- Chain Saw Carving
- Skidder & Knuckleboom Contests
- Continuing Education for Loggers
- Live Bluegrass Music and much more

For More Information On Exhibiting or Attending:

Kentucky Forest Industries Association
106 Progress Drive
Frankfort, KY 40601
Tel: 502/695-3979 Fax: 502/695-8343

www.kywoodexpo.com



Owners Retiring

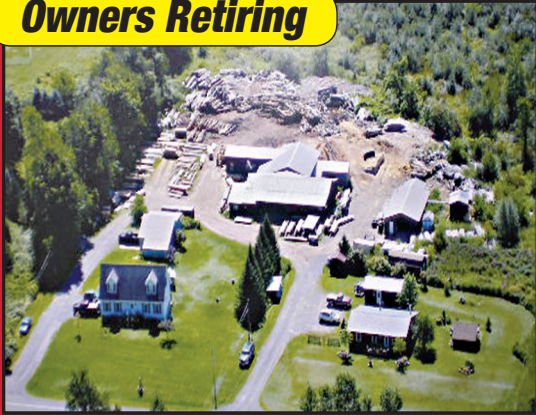

COMPLETE SAWMILL OPERATION FOR SALE

LOCATED IN UPSTATE NEW YORK

Equipment To Be Sold:

- 1) Wood-Mizer LT 300 Band Sawmill w/Log Deck, Off Feed Conveyor, Transfer Table & Green Chain
- 2) Wood-Mizer 2-Blade Electric Edger
- 3) Vermeer HG200 Grinder w/Chip Conveyor
- 4) Wood-Mizer Moulder M485SP (includes all knives & heads)
- 5) State Line 68kw Generator, 480 Volt



Also includes Blowers, Air Compressors, Lumber Carts, Bander, 480 Panel Boxes, etc.

Package Price for all equipment: \$162,500

Contact: Jim or Dave @ 518-736-1148 or e-mail jfrasier@albany.twcbc.com

All equipment & property includes 14 acres of land, approximately 5,700 square feet of buildings & 2 homes.

Package Price for equipment & land: \$475,000.

For information regarding the complete operation, contact: **CMK & Associates; Rick Roberts @ 518-435-5543** or e-mail rrobertscmk@gmail.com

WWW.LPS-INC.COM

6' Air Strain Left Hand McDonough Band Head Rig

LPS EQUIPMENT & ACQUISITION CO.
731-986-4351 | sales@lps-inc.com

800-598-3651



NEW MODELS AND OPTIONS NOW AVAILABLE!

- Longer Models
- Deburring Side Brushes
- Adjustable Fences

The GoFast Board Deduster features a simple, proven design to reduce sawdust headaches on boards.

- Use on any bandsaw (single or multi-head)
- No vacuum system needed!
- Uses (2) low-cost steel brushes
- Sweeps dust to the side to an exhaust port for easy removal
- Board Knocker Knocks frozen boards apart to prevent stalls

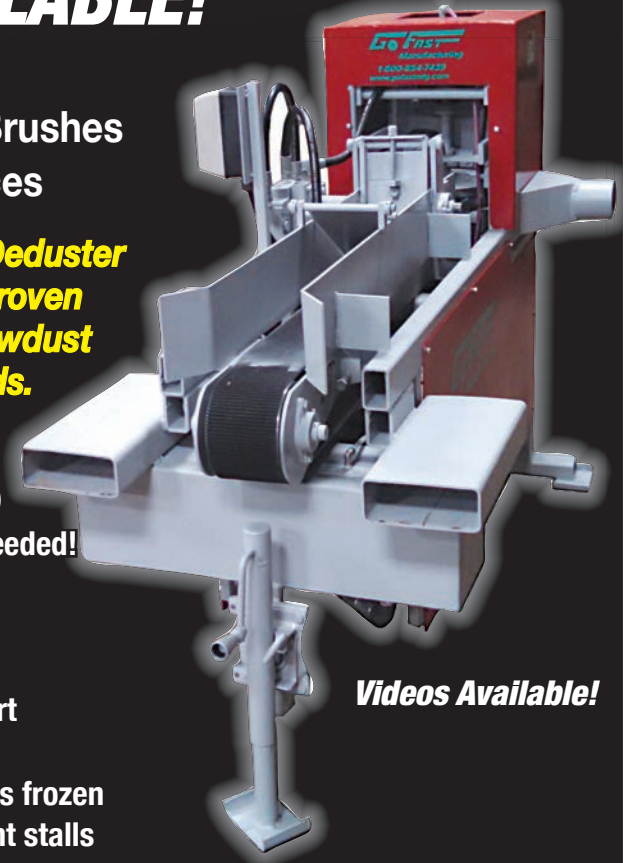

Videos Available!

Fast Production of Pallet Stock, Grade Lumber or Slab Recovery

GoFast Band Resaws are Better by Design!

- Single or Multi-head models to fit your needs.
- Gas or Electric / Single or 3 Phase
- Easy blade tracking
- Simple 1/8" to 6" thickness adjustment
- Self-contained hyd. variable feed — 0-130 FPM with turn of a dial

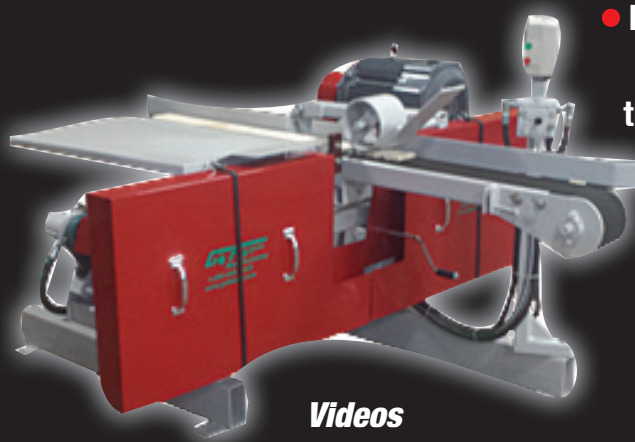

Videos Available!

Be Sure To Check Out

Our New Website!

www.gofastmfg.com

1-800-854-7439

E-Mail: sales@gofastmfg.com • Fax: 920-227-1961

We Have New and Refurbished Units Available

Resaws • DeDusters • Chopsaws • Grade Systems • Parts



JAMES G. MURPHY CO. AUCTIONEERS - NO MINIMUMS



PUBLIC AUCTION



JEM MACHINE

9AM - WEDNESDAY - SEPTEMBER 23
125 Airport Road, Grangeville, ID 83530
Sawmill & Reman Equipment



DEBARKERS - STACKERS - TRIMMERS - CUT OFF SAWS - BANDMILL
COMPRESSORS - DRYERS - CONVEYORS - HOGS - CHIPPERS
BLOWERS - FANS - MOTORS TO 500HP - ELECTRICAL - MOLDERS
4000' MILL CHAIN - TRANSFERS - ROLLING STOCK & MORE!
ALL ITEMS READY TO LOAD - NO DISMANTLING COSTS!

MURPHYAUCTION.COM - 1.800.426.3008

Precision 58" Chipper



1996 Model, 6-Knife,
Accepts up to a 15" Slab.
New Vertical Anvil, New Feed Plate,
New Wear Band, New Holder & Clamps.
Call 270-754-4087
(Robert or Anthony)

EQUIPMENT FOR SALE

- 5-Head Brewco B-800
2" Band Resaw Line, complete with roof top infeed, cant return, hydraulics & electrical panel
- 2-Head Brewco B-800,
2" Band Saws
- (2) Pendu E-Type Stackers

Call for photos or more info...

731-584-4157

Cole Pallet Co.
Camden, TN

The One Thing... Your Circle Sawmill Shouldn't Be Without!

The New AccraMax™ Quick-Change Mandrel Drastically Reduces Downtime!

- ▶ Features removable wear plates that can be changed out in 15 minutes or less!
- ▶ Save time!
- ▶ Save money!
- ▶ Greater blade cut accuracy!
- ▶ Longer blade life!
- ▶ Faster feeding speeds!
- ▶ Higher consistency!

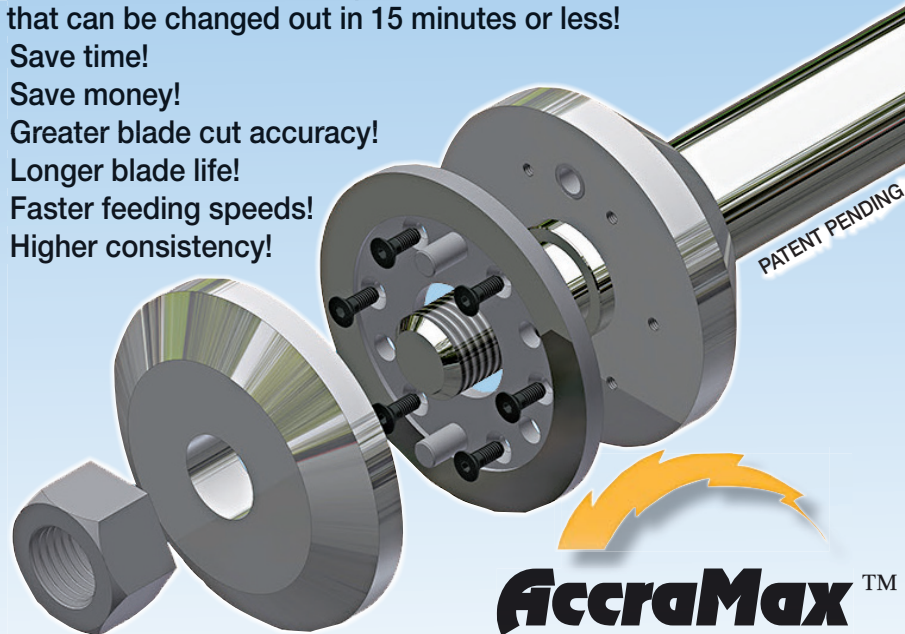

AccraMax™
QUICK-CHANGE MANDREL

For more information, call
260-568-2534 or **260-589-2244**
or visit www.accramax.com

Dealership inquiries are welcome

**Plan Ahead —
Cut Your Mill's Downtime.
Time is Money!**

Viking® Machine Parts For Sale

Call Jerry Lottes Parts Sales
(PH) **704-283-1920**
(CELL) **704-221-2205**
(FAX) **704-283-8716**

DID YOU KNOW? Montgomery Carriages Have Advantages...

Like this Custom FR Series Carriage

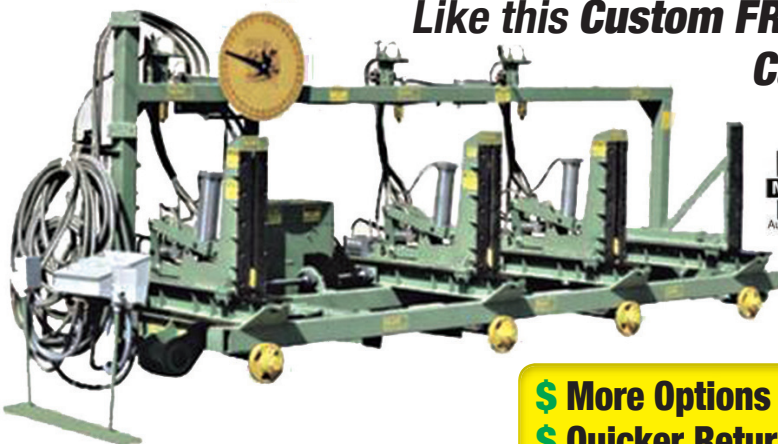

Call for details
1-888-806-8805
Sales@MontgomeryEquipment.com
www.montgomeryequipment.com

- \$ More Options
- \$ Quicker Return
- \$ 2-Yr. Limited Warranty
- \$ Optimal Performance on Today's Logs

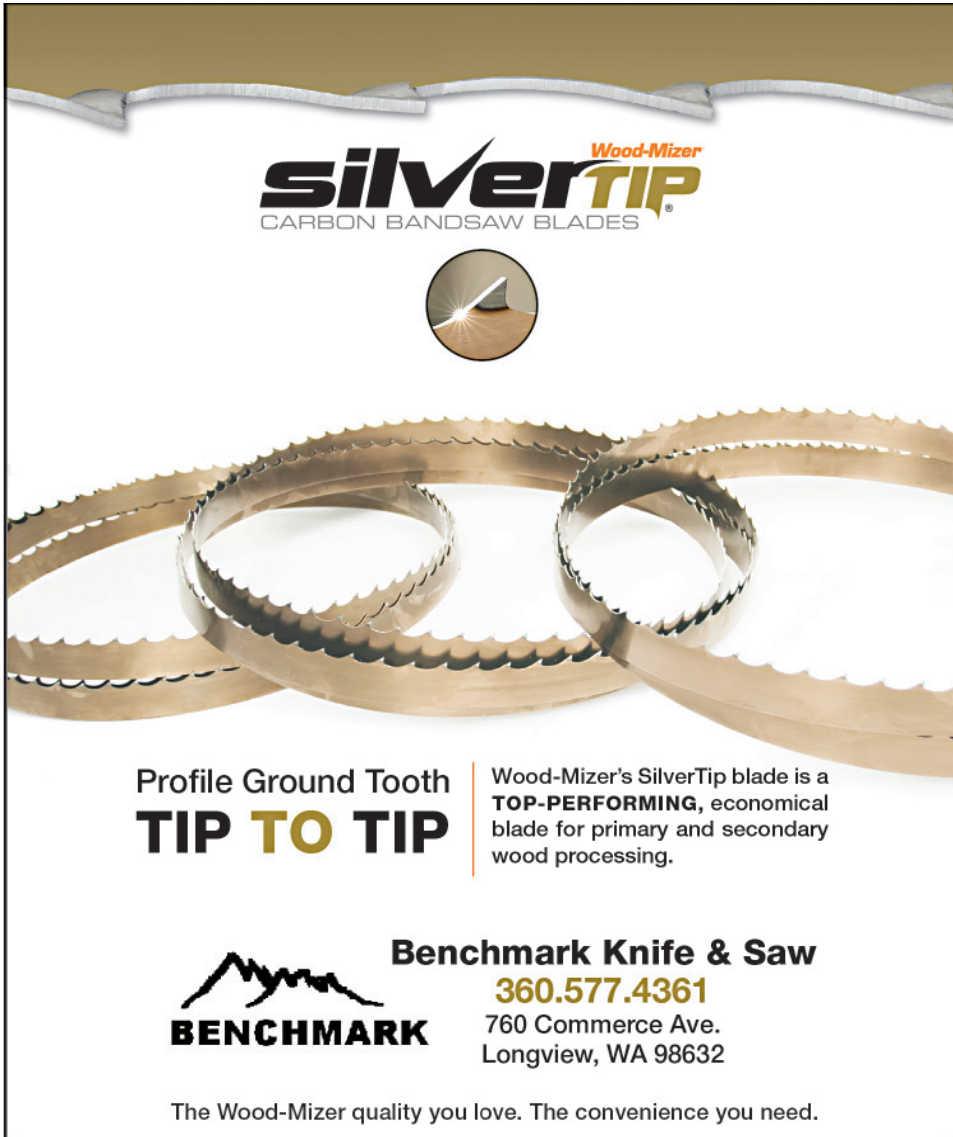

Wood-Mizer
silverTIP
CARBON BANDSAW BLADES

Profile Ground Tooth
TIP TO TIP

Wood-Mizer's SilverTip blade is a **TOP-PERFORMING**, economical blade for primary and secondary wood processing.

Benchmark Knife & Saw
360.577.4361
760 Commerce Ave.
Longview, WA 98632

BENCHMARK

The Wood-Mizer quality you love. The convenience you need.



WIN THE BATTLE
BETWEEN QUALITY AND PRICE.

A-8 Modified Chipper Steel Knives Inserts/Tips AR450 Grates

Don't sacrifice performance for price! Use Winn Wear Parts and Supplies' top-quality wear parts in your chippers and grinders. With high-quality materials like the A-8 modified chipper steel in our knives to the tungsten impregnated overlay on our inserts, our wear parts are built better to last longer...for less!

Winn
WEAR PARTS & SUPPLIES

Call for a quote today at 844-262-3649!
Or visit us at www.WinnParts.com



The OFFICIAL
The PAUL BUNYAN Show
THE ORIGINAL AMERICAN FORESTRY SHOW

OCTOBER
2nd-4th, 2015
GUERNSEY CO.
FAIRGROUNDS
CAMBRIDGE, OHIO

FOR MORE INFO VISIT OHIOFOREST.ORG OR CALL 888-38-TREES

- Logging, Sawmilling & Wood Manufacturing Sales & Demos
- Seminars from Industry Experts for Forestry Professionals (CE Credit Available)
- The 2015 Great Portable Sawmill Shootout®
- Ohio State and International Lumberjack Competitions
- Lumberjack Entertainment and Demos
- Heavy Equipment Demos
- Log Loader Competition
- Skid Steer Rodeo
- Fun Industry and Family Activities

Husqvarna
MORPHY TRACTOR & EQUIPMENT CO.
JOHN DEERE

INSPIRED BY TRADITION. POWERED BY INNOVATION.
THE OHIO FORESTRY ASSOCIATION

IT'S THE QUALITY THAT MAKES THE DIFFERENCE

Every machine that HMC builds and sells begins with sound, up-to-date engineering.

Whether a complete "turn-key" sawmill or individual machines to incorporate into your present mill, HMC engineers and builds quality sawmill equipment that maximizes production, insures safety, needs low maintenance and is rugged and reliable.

17° Slant Electric Linear Positioning Carriage



Featuring Mudata & USNR Optimization/Scanning



HMC MDS-50 Trimmers

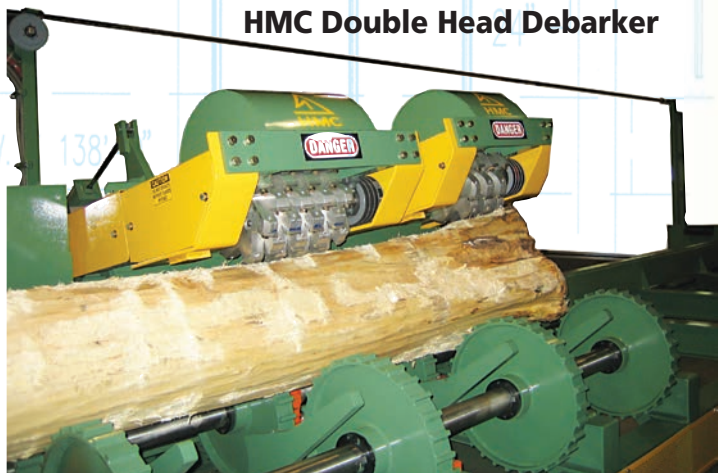
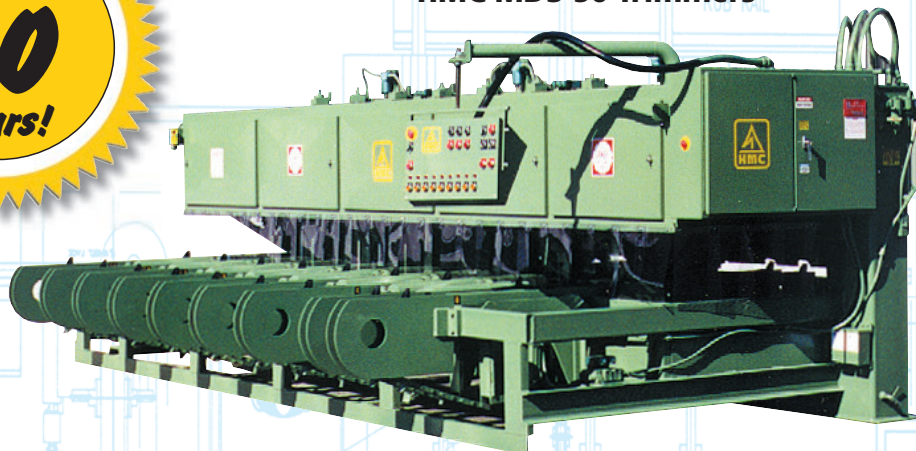

HMC Double Head Debarker

It costs no more to get the many benefits of HMC's full service - engineering and layout, quality product manufacturing, expert installations, sales & product support!



CALL 603-746-4691

284 Maple Street
Contoocook, NH 03229

www.hmccorp.com • Fax: 603-746-4819 • info@hmccorp.com

SIMONDS
INTERNATIONAL

silverTIP
Wood-Mizer
Wood-Mizer Blades

LENOX

PIPER'S
SAW SHOP

BEST BLADES!

BEST DEALS!

ALL IN ONE PLACE!



Ask about the
Piper Chopper
for your Scrap Blades!!!

800-845-6075

BUYING

Red
Aromatic
Cedar Logs

By the foot or
by the ton all year.

Call For New Pricing!

MILLER'S CEDAR Call Allen . . . Let Ring
HORSE CAVE, KENTUCKY **270-786-4316**



Cornell Chop

LEERAY & LUKE HORTON
218-372-4232
E-Mail: llsales@frontiernet.net

Knife Grinding Solutions!

Fully Automatic Cutterhead Grinders

- Grinds 7" to 16" dia. eased-edge, milled-to-pattern & fingerjoint cutterheads
- Completely enclosed grinding area for maximum safety
- All grinding debris & coolant are contained - no need for pneumatic airborne collection system
- User friendly touch screen operator panel



Rotary Knife Grinders — 3 Models Available



Precision Grinding — Chipper, Planer & Specialty Knives

- Grinding knife bevels from 25° to 40°
- Grinding speed of 50 to 150 FPM
- Built-in coolant system

Call Us Today!

NEWMAN
QUALITY WOODWORKING MACHINERY
SINCE 1907

Newman Machine Company, Inc.

336-273-8261

www.newmanwhitney.com
sales@newmanwhitney.com

Why Rely on U.S. Blades for Your Saws, Blades, Knives, Filing Room Supplies and More?

With 5 technologically advanced service centers, 15 delivery trucks and over 75,000 square feet of warehouse and factory space, U.S. Blades consistently delivers the leading edge to its customers.

From the green end to the planer mill, we are your single source supplier of high quality knives, saws, bandsaw blades and related maintenance supplies for sawmills.

Authorized Dealer For
SIMONDS
INTERNATIONAL

Armstrong

West Monroe, LA
14 employees
3 delivery trucks
15,000 sq. feet

Northport, AL
12 employees
2 delivery trucks
10,000 sq. feet

Florence, SC
27 employees
5 delivery trucks
20,000 sq. feet

Meridian, MS
15 employees
3 delivery trucks
15,000 sq. feet

Hampden, ME
14 employees
2 delivery trucks
15,000 sq. feet

Find out why our products are
"Feared by Trees Everywhere!"

U.S. BLADES

800-862-4544 • www.usblades.net

Midwest's Largest Forestry Trade Show & Equipment Expo

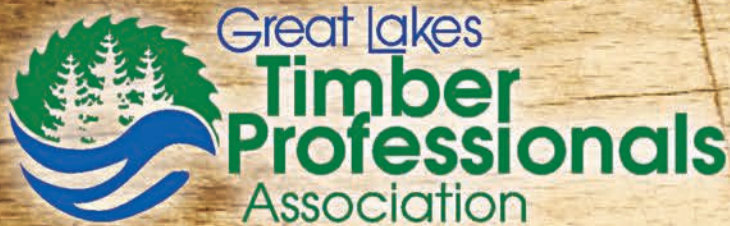

Open to the General Public
\$10 Admission Covers All Three Days

70th Annual

GREAT LAKES LOGGING AND HEAVY EQUIPMENT EXPO

September 10-12, 2015

U.P. State Fairgrounds

Escanaba, MI

For more information visit www.gltpa.org or call 715-282-7979

Superior Drying for Grade Lumber AND Pallet Treating... BOLDESIGNS Gives You More Options and Better Performance!



Smooth interior walls/ceiling for even air flow
Wall-to-wall heating coils for even heat distribution
Solid cast reversible aluminum fans for better air flow
Automatically raised baffles
Patented Wet Air™ Venting for fuel savings of 25-30%!



All aluminum construction
Non-corrosive mineral wool insulation
Customized size & shape
Easy operation, touch screen
Windows™ based controller
Techs onsite to train your operator
Easier in/out open chamber access

Call **BOLDESIGNS** at **1-800-645-7001**
P.O. Box 1586 Lenoir, NC 28645

See more at
www.drykilnbolddesigns.com

Don't Wait... Let Us Solve Your Drying Issues Today!

Need Hog Parts... NOW?
Don't Wait – Call The Hogman!

Toll Free 1-888-244-0161
www.ellisonsales.com

USED EQUIPMENT IN STOCK FOR SALE

NEW ARRIVALS TO PRS USED MACHINERY INVENTORY.
PRE-BUY NOW TO ENSURE AVAILABILITY.



VECOPLAN VAZ 2000 M-N
\$323,000

This machine is brand new and still in the crate!
Visit PRSGroupInc.com to view a product video.



VECOPLAN VAZ 2000 M-N
\$312,000

Machine is turn key and in excellent condition! Installed in April 2014 with only 6,700 hours of use.

New arrivals weekly, check our website for photos and details on the machines above and more...

Inspect any of these machines under power at our Illinois Facility



TOMORROW'S TECHNOLOGIES, TODAY

TOLL FREE (866) 546-8864
www.PRSGroupInc.com
email to: info@pallet-repair.com

Used Machinery Call Mona Tracy Today

- 1- Pallet Shop, Complete - Ohio
- 1- Stake Machine - Pencil Point
- 2- 2 Head Trim Saws
- 1- Air Compressor - Phase Converter
- 2- Morgan Portable Scraggs
- 1- Smart Band Saw/Trimmer Saw
- 4- Nailing Jigs/Tables, Revo
- 1- 3 Head Trio
Disassembler-Unstubber
- 1- Hand Held Brander
- 1- 12" Wide Resaw
- 1- T-Tek Sort System
- 1- Brewer D. A. Gang, Planer
- 2- Cant Sizers, Edgers
- 1- Band Saw Disassembler
- 2- Pallet Chiefs II
- 1- KM-16 4 Head
- 1- Single Notcher 1- Chamfer
- Blowers, Phase Converter-40 HP
- 1- Yield Pro - Sizer/Height
- 2- Solo, Pass I, Disassemblers
- 1- Tipper 1- Stacker 60 x 60
- 1- Baker Double Notcher
- 1- Pallet Sizer - Resize Pallets
- 1- Whole Pallet Notcher
- 1- Military Band Notcher -2 Head
- 1- Rayco Edge 2- Rayco Pro
- 1- 4 Head Brewer w/Deduster
- 1- Pallet Shop, Complete — Iowa
- 1- Gap Nailer
- 1- Brewco 5 Head Resaw

List your used equipment with us!

UNIVERSAL
MACHINERY SALES, INC.
Toll Free **1-855-298-8890**
or **812-298-8090**
E-Mail: info@universalmachinerysales.net

Headsaw Headaches?
See the Doctor at:
www.sawdoc.com

3 Brand New GE 2002 Golden Eagle Chamfers

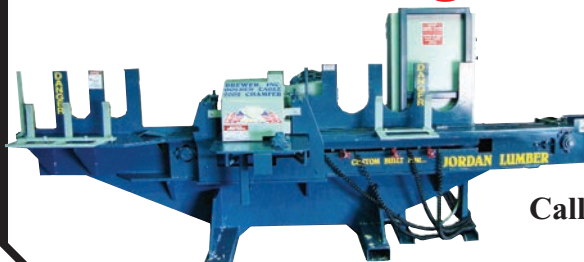

In stock & ready for immediate delivery!

Call 1-800-345-6516 or visit www.brewerinc.com

WV MINE TOOLS & SERVICE, INC.

WE ARE AT THE CUTTING EDGE OF YOUR BUSINESS!

Call TOLL FREE
888-291-5956



WV MINE TOOLS & SERVICE, INC.
PO Box 402, MT. Morris PA 15349
weaver399@msn.com

Try Our Popular **SABER INSERTED CARBIDE SAW BIT.**
Only \$2.45 per bit!

FREE SAMPLES!

▶ Dressing Sticks for wheels...
\$6.00 ea.

▶ \$75.00 for 4 inch Diamond Jockey Wheels

AMERICAN LUMBER AND PALLET

Home Categories Place an Ad Subscribe Digital Edition About Us Welcome, Guest! Log In Sign Up



Search Word Ads here...use any keywords...

All Categories

Search

New Listings



Call for Price

1996, Precision 58" Chipper, 6-Knife
Accepts up to a 15" slab, New vertical anvil, New feed plate, New wear band,



Call for Price

Other Baker Gas Edger
Edger. This machine is a Baker edger with 18hp gas motor. Item #CS71



\$12,000

Schutte-Buffalo Hog 1390
200 HP w/Soft Start & 24" Fan..... Bergstrom Wood Products 218-283-4557



Call for Price

Baker 12" Resaw For Sale.
Call 704-288-1904



Call for Price

Challenger 52" Grinder For Sale.
Call 704-288-1904



Call for Price

Hazelthorn Hazelthorn Chamfer For Sale.
Call 704-288-1904

- SAWMILL**
- Band Mills
- Blowers and Fans
- Carriages
- Chip Bin
- Chip Screens
- Chippers
- Circular Sawmill
- Conveyors
- Debarkers
- Dust Collection System
- Edgers-Board
- Forklift
- Hogs and Wood Grinders
- Knife Grinder
- Log Merchandising System
- Lumber Stacker
- Metal Detector
- Misc
- Portable Sawmill
- Resaw-Band
- Scragg Mill
- Sharpening Equipment
- Shavings Mill
- Trimmer
- Wheel Loader

- LOGGING**
- Log Loader Knuckleboom
- Slasher Saw

- AUCTIONS**
- Sawmill
- Pallet
- Logging
- Other

- BIOMASS**
- Hogs and Wood Grinders

- FINISHING**
- Other

- PALLET**
- Chamfer
- Chop Saw
- Deduster
- Gang Saw
- Hogs and Wood Grinders
- Lumber Stacker
- Misc
- Notcher
- Pallet Dismantler
- Pallet Heat Treating Kiln
- Pallet Nail and Assembly Systems
- Resaw-Band
- Trimmer

- WOODWORK**
- Gang Rip Saw
- Gang Saw
- Moulder
- Planer
- Straight Line

Click here to e-Subscribe for FREE

FOREST PRODUCTS MACHINERY & EQUIPMENT EXPOSITION

ATTEND LEARN PROFIT

June 10 - 12
Atlanta's Georgia World Congress Center

Upcoming Auctions view all



ASSOCIATED AUCTION COMP
Saturday, Apr 25, 2015
10:00am CDT
Hartville, OH
ABSOLUTE AUCTION
EXCESS SAWMILL & VENEER
224 E Maple Street • Hartville.

Search results for 'Sawmill' and 'Hogs and Wood Grinders'.

- Jeffrey 55 WB Wood and Bark Hog \$12,000
- Schutte-Buffalo Hog 1390 \$12,000
- Rotachopper SB-24 \$800-598-3651
- Jeffrey Hog 60HP \$800-244-0161
- Montgomery 57XLC \$888-244-0161
- Arasmith Bark Hog \$888-244-0161
- Montgomery 45CSKC \$888-244-0161
- 2007, Cresswood EF-12 - 2007 CRESSWOOD Horizontal Grinder EF-12 - 2007 \$888-244-0161
- Progress Ind Progress Hog Model 36 \$888-244-0161

The latest, easiest and most affordable way to buy or sell used equipment... For just one item to an entire yard of inventory — Check it out TODAY www.amlumber.com!

Mill Owners - Don't pay high commissions to sell your used machinery — List it on amlumber.com... **AFFORDABLY!**

Equipment Dealers - List your photos, all of them, on our convenient, easy to manage site.

Low cost packages available for online and print ads. Find out more by calling 800-727-9684 or 800-992-3432 (ext. 4) or go to www.amlumber.com.

Check Out The **NEW** www.amlumber.com Today!

LumberLine Laser

Now Available In Green!

**24 month warranty
24 hour repair turnaround**

5-30mW Units with a range of input voltages and configurations



sales@lumberlinelaser.com | toll free 855-686-3077 | www.lumberlinelaser.com 

Are Mold & Mildew on Your Pallets A Problem?



Eliminate It Affordably... Without Chemicals!
Air Drying Solves The Problem
and Makes Your Customers A LOT Happier

- ✓ Reduces moisture content and humidity
 - ✓ Uses a regular 53 ft. van specifically modified with vents and fans
 - ✓ Solves pallet storage problems
 - ✓ Reduces wasted time and improves efficiency
- Sell Your Pallets Easier Without Mold and Mildew!**



For more information, call Air-Flow Trailer Systems, LLC:
(262) 677-9033 or e-mail: aftstrailers@yahoo.com

www.aftstrailers.com



DISMANTLING BARS

"LIFETIME WARRANTY"

from... 

PR
PALLET REPAIR SYSTEMS, INC.

Pallet Repair Systems, Inc. • 3550 Mayflower Blvd. • Springfield, IL 62707
 PHONE: 217.291.0009 FAX: 217.291.0008
 TOLL FREE: 866-546-8864 www.pallet-repair.com

2015 ANNUAL INVENTORY REDUCTION SALE



Here Are a Few Examples of the GREAT DEALS on Quality Sawmill, Pallet, Rolling Stock & BioMass Equipment That Will Be SOLD!

OCTOBER 16 & 17 2015 • 9AM CST



Associated Auction & Liq. Co.
 PO Box 147 Clarksburg, TN 38324
 Fax: 731-986-4529
www.associatedauctioncompany.com
sales@associatedauctioncompany.com



BID LIVE ONLINE VIA WWW.PROXIBID.COM

Toll Free: 800-598-3651

TOMMY INGRAM AUCTIONEER TN LICENSE #3965 TN FIRM #5524

Join Our Mailing List! Call or E-mail for Complete Brochure

Bandsaw Blades — Welded to Length

Your Complete Service Shop for the Pacific Northwest!

Buy 10 Bands — Get 1 FREE!

Plus!

- * Carbide Saw Sharpening Service
- * Large Cutoff Saw Hammering
- * Resaw Manufacturing up to 7" wide



Call Sheila or Wendell for a quote today **1-253-272-0661**
 e-mail: sheblum@gmail.com or wblum@earthlink.net

Puget Sound Saw Puyallup, WA



SAVE \$\$\$

Our metal connector plates repair wooden pallets to a like-new condition. High quality, superior strength.



Ready to Ship!

PALLET REPAIR SYSTEMS, INC.
866-546-8864
 Fax: 217-291-0008
www.pallet-repair.com/alp

WWW.ELLISONSALES.COM



Precision 58in 6K ChipPack, 10317-1

ELLISON SALES

888-244-0161

E-mail: dan@ellisonsales.com

DOUBLE the Life of your Bandsaw Blades in only 15 Minutes!!!



True Wheel, a patent-pending revolutionary new hand tool machine, will change the way you crown and smooth your bandsaw wheels. The True Wheel will cut your blade usage from 3 to 4 blades per day down to only one! Potentially save \$10,000 to \$20,000 in blade usage per year!

Manufactured & sold by True Wheel LLC Sales & Marketing.

For more information, contact:

931-469-5557 or 931-469-5558
www.truewheelllc.com

LITCO IS SEEKING A PACKAGING PROFESSIONAL TO SELL THE INCA® MOLDED WOOD PALLET

Do you want to be part of a growing company and sell an exclusive product?

If so, please apply only if you meet all four of the following prerequisites:

- 1.) Located in or near Louisville, KY, Southern IN, IL, MO or Eastern PA, or Northeastern USA.
- 2.) Willing to travel multiple states
- 3.) Have 5+ years of experience and a list of established contacts that palletize for both export and domestic shipping.
- 4.) Have a proven record of sales success and a list of established contacts.

Our ideal candidate

- Has a reputation for honesty and integrity.
- Able to withstand rejection and not give up.
- Enjoys maintaining and building lasting relationships
- Non-smoker

Litco offers a comprehensive benefit package and a competitive compensation program with the opportunity for advancement.

Preferred Requirements: A bachelor's degree in business or engineering. Fluency in English. Bilingual verbal and written skills are beneficial. Working knowledge of Excel, Word & CRM.

If you believe that you are our ideal candidate, visit our careers page at:

<http://www.litco.com/careers/> or e-mail resume and cover letter to careers@Litco.com.

FOR SALE

- ✓ Shotgun Feedworks
 - ✓ Thornton Planer
 - ✓ Robinson 36" Resaw
- 815-273-3333**

RETOOL REPOSITION RELAUNCH



1-1/2" RADIUS NOTCHING HEAD



1/2" RADIUS INDEXABLE NOTCHING HEAD



HIGH SPEED BRAZED SURFACING HEADS



INDEXABLE/ SIZER PLANER HEAD



FENCE POST PROFILE BRAZED HEAD



CORNER ROUNDER INSERT HEAD

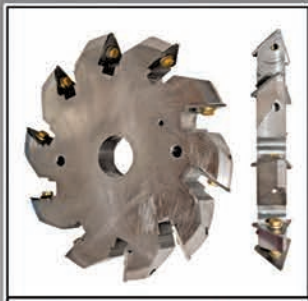

INSERT CHAMFER CUTTERS

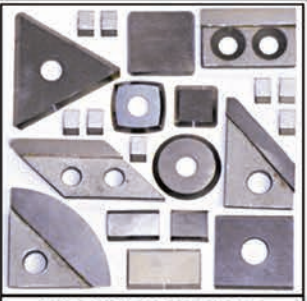

INDEXABLE INSERTS & SAW TIPS



EDGER/CHIPPER BRAZED HEAD

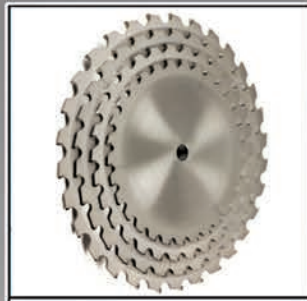

NAILBUSTER[®] SAW BLADES



GENERAL PURPOSE WOOD CUTTING SAW BLADES
• STROB SAWS • RIP SAWS
• CROSS CUT • CUSTOM

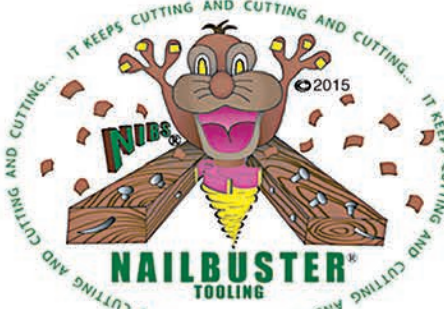

NAILBUSTER[®] TOOLING
CUTTING WOOD WITH NAILS
CUTTER HEADS • SAW BLADES
INDEXABLE INSERTS
20 YEARS EXPERIENCE



John Lieber, President



CUSTOM ENGINEERED TOOLING

PROFILE TECHNOLOGY INC.

9116 Rott Rd.
St. Louis, MO 63127

TEL 314-965-9111
FAX 314-966-5550

info@profiletech.com
www.profiletech.com

North America **800-369-4242** Since 1970



David Lieber, Sales Engineer

The Morgan Line-Up!

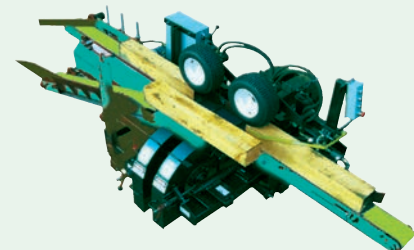

Original Single Head Resaw

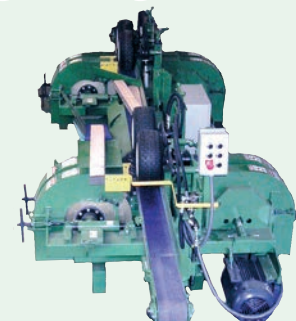

4-Head Resaw



Wide Cut Resaw



Multi-Head Trim Saw



Military Band Notcher

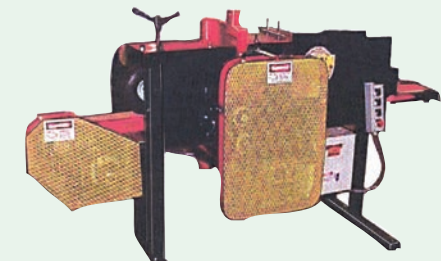

Board Duster



UNIVERSAL
MACHINERY SALES, INC.

Call Mona Tracy

855-298-8890
or **812-298-8090**

sales.universalmachinerysales@gmail.com

Buy and Sell Used Equipment On-The-Go!



Just go to the **NEW amlumber.com**
from your tablet or smartphone
and find what you need — **FAST!**

Let's get right to the point.

Sawblade.com reduces your bandsaw costs significantly.

Here's just one example of how you can save significant amounts on the cost of your blades with Sawblade.com:



22' x 1-1/4" x 5/8"
M42 Rugged Tooth™
Bimetal Sawblades
package of 10
only **\$373.00**
(includes shipping)

All blades have the new Rugged Tooth design and come with plastic tooth capping for the protection of the operator and blade teeth during shipment. In addition to great savings, you'll also receive free shipping on all orders over 150.00, and same day service. Visit us online or give us a call. Start saving today!

Please note that blades are only sold in boxes of 10.

SAWBLADE•COM
RUN LEAN

800.754.6920

EVERYTHING YOU NEED FOR YOUR PALLET OR SAWMILL LINE

PALLET EQUIPMENT



CUT OFF SAWS

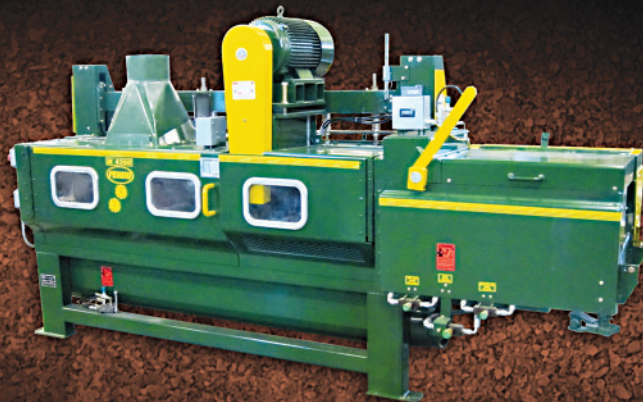

GANG SAWS

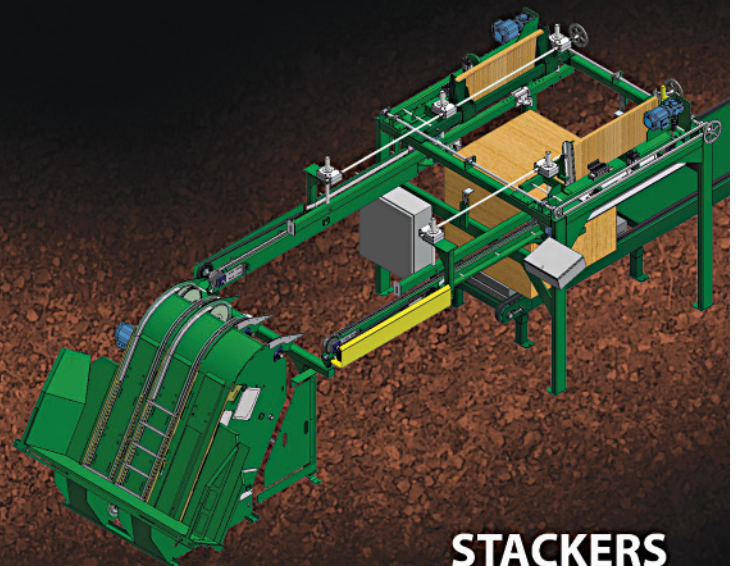

STACKERS

SAWMILL EQUIPMENT



2 SAW TRIMMERS



MULTI-HEAD TRIM SAWS



EDGERS



PENDU ALSO BUILDS SEVERAL MODELS OF SCRAGG MILLS, NOTCHERS, BAND SAWS, BLOWERS, & MORE! CALL OR VISIT OUR WEBSITE FOR MORE INFO!

Stackers Trim Saws Gang Saws Scragg Mills Edgers Custom Equipment
800.233.0471 717.354.4348 www.Pendu.com