



www.amlumber.com  
**October 2015**

# American Lumber & Pallet

**Sawmills • Pallet Mills • Woodworking • Logging 1-800-992-3432**

Loaded with Pages and Pages of New & Used Equipment and More!

## In This Issue:

### Auctions

#### Tri-State Auction & Realty, LLC:

October 15th • Cadiz, KY  
 Page 50

October 24th • Stuart, VA  
 Page 51

November 7th • Boss, MO  
 Page 52

#### Associated Auction & Liquidation Co.:

October 9th • Gouverneur, NY  
 Page 55

October 10th • Henry, TN  
 Pages 56-57

October 24th • Beaufort, NC  
 Page 58

October 16-17th • Bruceton, TN  
 Pages 64-65

#### James G. Murphy Co.:

October 20-22nd • Shelton, WA  
 Page 60

November 4-5th • Tacoma, WA  
 Page 67

### Hot On The Market!

MaxFlex Sawmill Blades

Scissor Lifts

... Page 69

### Digital Edition

Visit us online at  
**www.amlumber.com**  
 for the latest products,  
 auctions, equipment  
 listings and more!



**ONE PASS=  
 ONE TIE**

**MORE EFFICIENT  
 TIE PRODUCTION WITH THE  
 TIMBERLAND BIG JAKE 4000 SCRAGG  
 BY BREWCO**

**BREWCO**  
 INCORPORATED  
 RUGGED • RELIABLE • DEPENDABLE

www.brewcoinc.com  
**800.237.6880**  
 607 Front St. • Central City, KY 42330

10-15

**PRESORTED  
 STANDARD  
 U.S. Postage Paid  
 Atlanta, GA  
 Permit No. 3592**

**AMERICAN LUMBER & PALLET  
 P.O. BOX 1136  
 FAYETTEVILLE, TN 37334**



**Grizzly Industrial**

**PURVEYORS OF FINE MACHINERY®, SINCE 1983!**

- OVER A MILLION SQUARE FEET PACKED TO THE RAFTERS WITH MACHINERY & TOOLS
- 2 OVERSEAS QUALITY CONTROL OFFICES STAFFED WITH QUALIFIED GRIZZLY ENGINEERS
- HUGE PARTS FACILITY WITH OVER 1 MILLION PARTS IN STOCK AT ALL TIMES
- TRAINED SERVICE TECHNICIANS AT ALL 3 LOCATIONS • MOST ORDERS SHIP THE SAME DAY

**14" SLIDING TABLE SAW**

- Main motor: 10 HP, 220V/440V\*, 3-phase, 28A/14A
- Sliding table size: 15" x 126"
- Main blade arbor: 1"
- Main blade speed: 3000, 4000, 5000, 6000 RPM
- Scoring blade motor: 1 HP, 3A/1.5A
- Scoring blade size: 4 3/4"
- Scoring blade arbor: 22mm
- Scoring blade speed: 8000 RPM
- Scoring blade tilt: 0-45°
- Depth of cut: 4" @ 90°, 2 3/4" @ 45°
- Max. rip capacity: 52 1/2"
- Max. sheet capacity: 126" x 126"
- Overall dimensions: 132" W x 55" H x 130" D
- Approx. shipping weight: 2932 lbs.

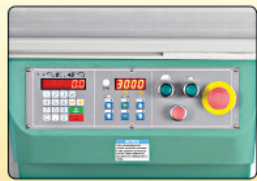

**G0772 ONLY \$10,950<sup>00</sup>**

**14" 10 HP, 3-PHASE SLIDING TABLE SAW**

- Main motor: 10 HP, 220V/440V\*, 3-phase
- Main blade size: 14" • Main blade tilt: 0-45°
- Depth of cut @ 90°: 4 1/8", @ 45°: 2 7/8"
- Main blade speed: 3000, 4000, 5000 RPM
- Main blade arbor: 1"
- Scoring motor: 1 HP, 220V/440V\*, 3-phase
- Scoring blade size: 4 3/4"
- Scoring blade arbor: 20mm
- Scoring blade speed: 8000 RPM
- Scoring blade tilt: 0-45°
- Sliding table size: 14" x 126"
- Max. rip capacity: 51 1/4"
- Overall dimensions: 202" W x 65" H x 133" D
- Approx. shipping weight: 1815 lbs.



**G0764 ONLY \$7500<sup>00</sup>**

**STRAIGHT LINE RIP SAW**

- Main motor: 15 HP, 220V/440V\*, 3-phase
- Feed motor: 2 HP, 220V/440V\*, 3-phase
- Amps: 43A at 220V, 21.5A at 440V
- Table size: 53" x 37"
- Floor-to-table height: 32 1/4"
- Maximum cutting thickness: 3 7/8"
- Minimum cutting length: 8" (with included hold-down roller kit)
- Feed speed (variable): 30-112 FPM
- Saw blade diameter: 10"-12"
- Maximum cutting width: 18"
- Arbor diameter: 1"
- Spindle speed: 4500 RPM
- Dust port diameter: (1) 4"
- Overall dimensions: 61 1/4" long x 43 1/2" wide x 80 1/2" high
- Approx. shipping weight: 2243 lbs.

**3 7/8" MAXIMUM CUTTING HEIGHT**

SHOWN WITH OPTIONAL LASER GUIDE (H5749)



**G0524 \$8250.00**  
**SALE \$7500<sup>00</sup>**

**AUTOMATIC EDGE BANDER**

- Required power supply: 30A, 220V, single-phase, 60 Hz
- Feed motor: 3/4 HP
- Glue and edge motor: 1/4 HP
- End trim motor: 1/4 HP
- Flush trim motor: 3/4 HP
- Buffing motor: 1/4 HP
- Heating element: 1455W (6.6A)
- Table size: 10 1/2" W x 78 3/4" L
- Min. panel dimensions: 4 3/4" W x 9 1/2" L
- Panel thickness: 14mm-40mm
- Tape thickness: 0.5mm-3.0mm
- Compressed air required: 86 PSI
- Glue pot capacity: 34 oz.
- Roller width: 2 5/8"
- Roller diameter: 1 3/8"
- Edgebanding coil capacity: 31 1/2"
- Dust collection ports: 2
- Approximate shipping weight: 875 lbs.

**New!**

MADE IN ISO 9001 FACTORY



**G0774 \$9995.00**  
**SALE \$9500<sup>00</sup>**

**PRICING CODE**  
**15AMLUM**  
MENTION THIS CODE WHEN PLACING YOUR ORDER  
17616

**1-800-523-4777** **grizzly.com**

VIEW VIDEOS AT [grizzly.com](http://grizzly.com)

TECHNICAL SERVICE: 570-546-9663 • FAX: 800-438-5901  
3 GREAT SHOWROOMS!  
BELLINGHAM, WA • MUNCY, PA • SPRINGFIELD, MO



# TO MAKE EVERY DOLLAR COUNT— YOU HAVE TO MAKE EVERY CUT COUNT



**Selecut<sup>®</sup> V with Inline Squeeze**

- For prime lumber cut to length or Precision End Trimming needs, our Selecut<sup>®</sup>-V uses a Fixed Frame Assembly with a moveable cutting platform to meet your production needs in a limited space environment and is available with our Inline Power-Squeeze Package Alignment system.
- For high-volume automated crosscutting of industrial length stock, our Autocut<sup>®</sup>-V uses a computerized carriage assembly with PLC controls enabling you to process lumber without an operator present.

**Transcut<sup>®</sup> II Station**

from \$26,999\*

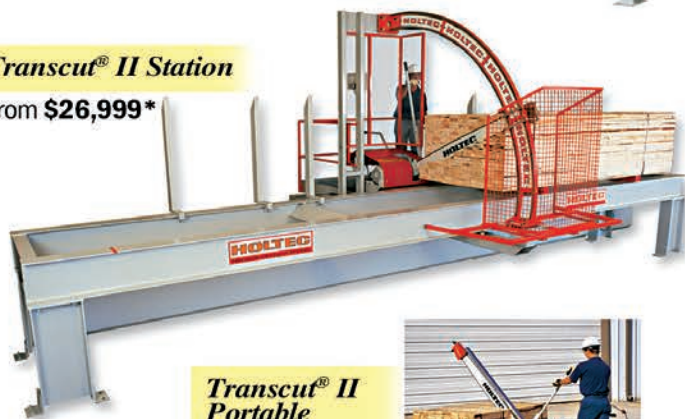

**Transcut<sup>®</sup> II Portable**

from \$7,999\*



- For custom manufacturers, our Transcut<sup>®</sup> II Station will cleanly cut through a unit of hardwood or softwood in less than a minute using generic chain-saw chain and with a precision of +/- 1/16th" or better\*.
- For simple crosscutting of EWP or lumber, our versatile Transcut<sup>®</sup> Portable saws are priced and designed to offer a significantly safer and faster alternative to hand-held chain saws.

**We're proud of the fact that HOLTEC pioneered the concept of precise package cutting over 40 years ago. Today our industry's technological and manufacturing advances have enabled us to achieve the fastest cut in the industry and an unmatched precision on every cut. So, if you're considering investing in a package-crosscut saw, consider these facts\*:**

- At 55 seconds per cut HOLTEC systems cut up to twice as fast as other systems available today;
- With our own team of dedicated Field Technicians and service vehicles, HOLTEC is the only company that provides you a service response time of 24 hours or less on-site and on-time;
- Our state of the art Germany manufacturing facilities are ISO-9001 certified, ensuring that you're getting the highest quality manufacturing standards available today;
- With an unmatched precision of +/- 1mm (.040"), HOLTEC systems exceed precision-end-trim tolerances;
- HOLTEC systems are designed with the highest safety standards in the world, ensuring that your employees are working in the safest environment for package-crosscutting available today;
- HOLTEC has almost 2,000 systems in North America and over 8,000 systems delivered worldwide, ensuring that we'll be here for you in the future as we have been for the last 40 years

**WE ENSURE EVERY DOLLAR COUNTS BY ENSURING EVERY CUT COUNTS**

# HOLTEC<sup>®</sup>

PRECISION CROSSCUT SYSTEMS

[www.holtecusa.com](http://www.holtecusa.com)

**Holtec [USA] Corporation, 2802 Sydney Road, Plant City, Florida 33566 • [813] 754-1665 • Fax [813] 752-8042  
TOLL FREE 1-800-346-5832 • eMail: [info@holtecusa.com](mailto:info@holtecusa.com)**

\*All specifications are subject to change without notice. Pricing is FOB Tampa, Florida and subject to change without notice. Photographs may show systems with optional accessories. On-site service may not be available in certain remote locations. Proper maintenance procedures are essential for accuracy and longevity, and accuracy results are based on HOLTEC installed systems using Scratcher<sup>®</sup> chain technology. Stroke speed may vary based on specie and dimension of lumber. HOLTEC, TRANSCUT, SELECUT, AUTOCUT & MAXIMUS are registered trademarks of HOLTEC GmbH. All other trademarks are the property of their respective owners. Warranty and guarantee terms are subject to limitations and delivery or installation to certain remote locations may incur additional charges. ©2015 HOLTEC (U.S.A.) Corporation

# Ask About Our Freight Assistance Program!

We Have the Industry's **BEST** Reputation for Used Sawmill and Planing Mill Equipment!



Two Nice XL Rippers



Sprout Hammer Mill



20-Unit Peerless Bin



Precision 6-Knife Rotary Grinder



Precision 5X5 2-Deck Screener



Hazeldine Chamfer Machine



Morbark 48 in. Chip Pac



Morbark 640 Debarker



McDonough 54 in. Resaw



WSM 2432 Hammer Hog



Black Clawson 48 in. Chipper

***This is only a small selection from our HUGE inventory.***  
Visit our website – **[www.machinerysales.com](http://www.machinerysales.com)** – or call us for help with your next project.



Weinig Profimat Moulder



Precision 66 in. Chipper



Soderhamn 6 x 6 Chip Screen



Whirlwind 212L Chopsaw & Tiger Stop



Morgan Shifting Edger



Salem 6 ft. High Strain Bandmill



**MACHINERY SALES CO.**

503-285-6691

Fax 503-285-0449

9802 North Vancouver Way

Portland, OR 97217

**Over 10 Acres of Machinery In Stock!**

Call (Toll Free) **1-866-241-2977**

For a complete equipment listing, go to

**[www.machinerysales.com](http://www.machinerysales.com)**

e-mail: [machsales@msn.com](mailto:machsales@msn.com)

# Unleash the Awesome Power of the Verticut P4!

**Now with inline**  
*(One step Cut in Two)*

**SQUEEZE**

Learn more about L-M Equipment on



Search: **LM Corporate Video**



**Precision. Performance. Production. Profit.**

Perfect for Rig Mat & Truss Stock, L-M's Verticut P4 consistently delivers a P.E.T. cutting tolerance of  $\pm 1/32"$  and a trim end finish that is as good or better than conventional trim saws.

*Built to Provide Service, NOT Require It*



*The Verticut P4 is one great machine in the L-M family of efficient, cost effective package lumber cutters. With 60 years in the business, L-M Equipment has more package cross cut systems in operation than any other manufacturer in North America. We serve customers around the world.*

*Contact L-M Equipment for more information!*

**Features include:**

- Programmable touch screen
- Automated PLC controls
- Remote starting
- Operator weather protection
- FACT™—Fast Advance Cutting Technology to substantially reduce cutting cycle time.



**L-M Equipment Company Ltd.**  
604-576-0088 • Fax: 604-576-0089  
Toll Free 1-800-455-8807  
Email: sales@LMSaws.com  
**www.LMSaws.com**



Portable Yard Saw



I-CUT



**PreSharp™**  
**IS REAL SHARP!**

PreSharp™ IS AVAILABLE IN 3 WIDTHS:  
• 1" OS wide • 1-1/4" wide • 1-1/2" wide

**Not all Ground Tooth blades are created equal!**

**PreSharp™**  
SQUARE FACE BLADE DETAIL

Simonds PreSharp™ blades have a unique, square-face cutting edge.

Conventional blades, even "ground tooth" types, have a twist on the face. This twist pushes saw dust to the sides of the blade, potentially causing poor tracking and dust spillage.

## BANDSAW BLADES FOR ALL CUTTING APPLICATIONS

MAKE SIMONDS YOUR SOURCE FOR PORTABLE SAWMILL BLADES, FIREWOOD PROCESSING SAWS, SAW TEETH, & CHIPPER KNIVES.



SAWBLADES AND TEETH FOR FIREWOOD PROCESSING SAWS



CHIPPER KNIVES



INSERTED TOOTH SAWS

CALL FOR THE DEALER NEAREST YOU

1-800-426-6226

**SIMONDS INTERNATIONAL** [www.simondsinternational.com](http://www.simondsinternational.com)

Simonds International Fitchburg, Mass. USA





**American Lumber & Pallet**  
*Sawmills, Pallet Mills, Woodworking, Logging*

Published Monthly By:  
**ASKINS PUBLISHING GROUP, INC.**  
P.O. Box 1136  
Fayetteville, TN 37334

**PUBLISHER/EDITOR**  
Bill Askins  
bill@amlumber.com

**ADVERTISING SALES**  
Shawn Askins  
shawn@amlumber.com  
**1-800-727-9684**

Randy Tallman  
randy@amlumber.com  
**1-800-992-3432**

**CIRCULATION DEPT.**  
circulation@amlumber.com

**GRAPHIC DESIGN DEPT.**  
Jeff Moyers  
jeff@amlumber.com

Barbara Locker  
bop@amlumber.com

**PHONE: (931) 433-1010**

**TOLL FREE:**  
**800-992-3432**  
*Anywhere in the U.S.A. & Canada*

**FAX: 931-433-1081**

**E-MAIL** alp@amlumber.com  
[www.amlumber.com](http://www.amlumber.com)

**Subscriptions (Presorted Standard Mail)**  
Free to Sawmills, Pallet Operations, Woodworkers, Veneer & Chip Mills and Loggers with portable sawmills in the U.S. Other businesses or individuals in the U.S. \$25.00 per year.

**Subscriptions (First Class Mail)**  
U.S.A and CANADA - \$50.00 per year.  
Other foreign subscriptions call for prices.





Any advertising copy submitted for publication is deemed the property of the advertiser, and is used on the condition that all liability for copyright laws is the sole responsibility of the advertiser.

©August, 1990

Are You Using The RIGHT Lumber Markers?

AMARK gives you the best Quality, Price & Service!

Shop online at [www.amarkers.com](http://www.amarkers.com)  
e-mail: sales@amarkers.com

Call toll free 1-866-662-6275

NOW BUYING

Used Pallet and Pallet Recycling Machinery.

1-800-348-0703

 NOBLE MACHINERY CO. INC.

WANTED!

Aromatic Cedar Logs

Paying \$1.50 BF Doyle Scale

270-522-0769

Shanty Pallets  
9295 South Rd. • Cadiz, KY 42211



## HUD-SON's 60" Diameter Sawmill Will Cut GREAT Slab Wood!

These slabs make **GREAT** counter or bar tops, perfect for furniture and cabinet "makers".

Our band wheels ride on a heavy-duty 1 15/16" shaft supported by two pillow block bearings on each side of the wheel. This configuration distributes the pressure load evenly over the shaft to eliminate premature shaft or bearing failure.

We believe so strongly in this we guarantee the main bearings and shafts for 6 YEARS!



**HUD-SON** 8201 State Route 12  
Barneveld New York 13304  
FOREST EQUIPMENT 800.765.SAWS • WWW.HUD-SON.COM

You need sensors that work reliably in areas with...

CONDENSATION

STEAM & FOG

SAWDUST

## Pantron Sensors

- Blast through steam, sawdust, & fog
- Not affected by vibration or sunlight
- Through-beam range up to 230 feet
- Eliminates need for compressed air

## The Industry Standard for Trimming Excellence!



**KM-16 Multiple Trimmers from Newman Machine are the "Go-to" choice for precision, high speed trimming.**

Quickly trim your lumber into multiple lengths at high production levels!

Low Maintenance ■ Fast, Easy Setup ■ Quick Change Saw Arbors

*Backed by our standard warranty and supported by our second-to-none parts & service department.*

**NEWMAN**  
QUALITY WOODWORKING MACHINERY  
SINCE 1907  
Newman Machine Company, Inc.

**336-273-8261**

www.newmanwhitney.com  
sales@newmanwhitney.com

Perfect for Sawmills!

Call toll-free or visit us on the web  
1-800-211-9468  
pantron.com

**pantron**  
automation, inc.



WWW.FRONTLINEEQUIPMENT.NET  
**FRONTLINE EQUIPMENT, LLC**  
 Out Front Where Things Happen

**FRONTLINE EDGER**  
 MODEL F642

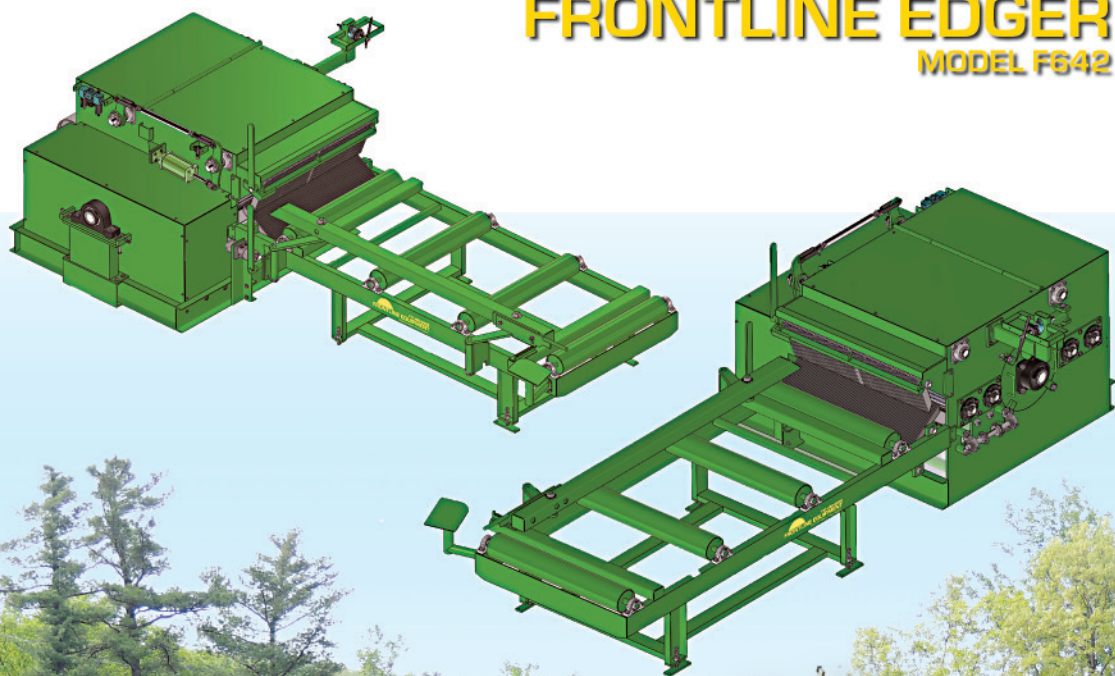

# FRONTLINE EDGERS

*Now Available!*

The F642 HD Edger is designed and patterned after the long lasting and dependable Reckart Edger. The same Heavy Duty construction and quality-craftsmanship you have come to expect from Reckart Edgers is now built into the FRONTLINE Edgers with most parts being interchangeable. Call today for information on the New FRONTLINE Edgers and other equipment FRONTLINE is now manufacturing.

9267 Front Mountain Road  
 Allensville, PA 17002

**717-483-6556**

Fax 717-483-6051

Email [parts@frontlineequip.com](mailto:parts@frontlineequip.com)



Blowers F42 & F26



Log Turner FT40



Waste Conveyor





**HAS SOLUTIONS FOR YOUR MILL EQUIPMENT ISSUES**

YOUR ONE STOP FOR QUALITY CUSTOM SAWMILL EQUIPMENT SINCE 1965

FROM CUTUP SYSTEMS

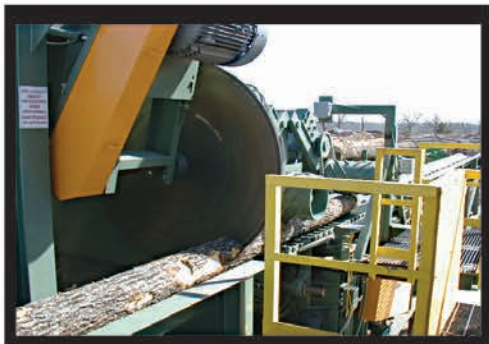

AND EVERYTHING IN BETWEEN



TO STACKING SYSTEMS

- Overhead Scraggs
- Chain Scraggs
- Cutup Systems
- Gangs
- Trimmers
- Edgers
- Stackers
- Carriages
- Resaws
- Stave Equipment
- Dry Kilns
- Metal Detectors
- Chippers
- Vibrating Conveyors
- Butt Reducers
- Debarkers
- Decks, Rollcases and Troughs
- 3D Optimization

**DON'T WAIT, GIVE US A CALL AT 478-252-5885**

EMAIL: [INFO@COOPERMACHINE.COM](mailto:INFO@COOPERMACHINE.COM) WEBSITE: [WWW.COOPERMACHINE.COM](http://WWW.COOPERMACHINE.COM)  
 YOUTUBE: [WWW.YOUTUBE.COM/COOPERMACHINECOINC](http://WWW.YOUTUBE.COM/COOPERMACHINECOINC)

**Live Floor Trailers**

From Pickup Truck Beds to 53'

**BUY • SELL  
RENT • NEW & USED**

Full Repair Service & Parts for Keith & Hallco Wet Kits, Hyd. Pumps, Valves, Hoses & More.

If You're Thinking LIVE FLOOR — **THINK FERGUSON FARMS!**

**800-326-4919**

Fax 574-453-3900 Cell 574-453-7120  
We Now Handle Western Belt Trailers!

**1998 Bandit 3680 Beast Mobile Wood Grinder**



**Must See!..... \$129,500**

Under 1800 hrs., owned & operated by fussy old man. Trades considered.

**203-268-8994 (CT)**

**You Deserve the Longest Running Blades *Anywhere!***

**Never Run Out of Bands Again!!**



3" - 8" Wide Single-Cut Bands

4" - 6" Wide Double-Cut Bands

Ask for Our...

**S W A G E T O O T H** or our finest **S T E L L I T E** Tipped Bands



**Complete Resaw Package with 13 Stellite® Bands Delivered in USA — Only \$44,900**

**Sharpen Your Own Bands in Minutes!**

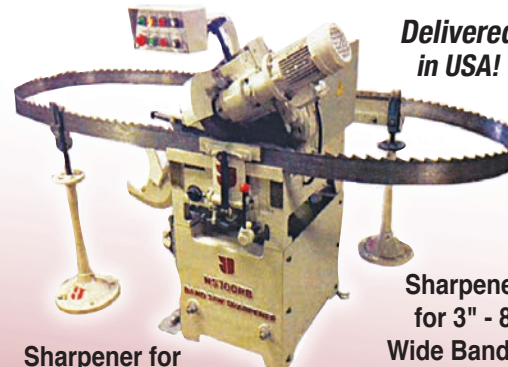

**Delivered in USA!**

Sharpener for 2" - 7" Wide Bands - \$7,100

Sharpener for 3" - 8" Wide Bands \$8,900

**TMS TRADING INC.**

T: 704-539-4117

C: 704-902-9688

Call Lamarr King, President  
Union Grove, NC 28689

[LAMARR.TMSTRADING@OUTLOOK.COM](mailto:LAMARR.TMSTRADING@OUTLOOK.COM)

**Complete Saw, Band, Knife & Cutting Tool Sharpening Service**



# BAKER MODEL 3650E BP DOMINATOR



**TAILING CONVEYOR**



**BAKER'S  
HIGHEST  
PRODUCTION  
SAWMILL ON  
THE MARKET!**

**BRIEF:**

The Baker BP Dominator™ Stationary Band Sawmill is designed for industrial-strength, high production saw-milling. A 50-hp electric motor powers your way through hardwood logs measuring up to 36" in diameter. This sawmill differs because of the rear Tailing Conveyor that catches and sends cut material out the back of the mill. Hydraulic controls are located on the operator control console chair. Two 36" diameter, all-steel band wheels help to extend blade life. A laser light, in-line debarker, and setworks come standard.

**FEATURES:**

**MAIN DRIVE:**  
50-HP TEFC Electric Motor  
**CUTTING CAPACITY:**  
36 in. diameter  
20.5 ft. length  
**FULLY HYDRAULIC:**  
Log loader, log turner, fence arms/clamp, and toe rollers  
Remote operator's control station with comfortable chair

**OPTIONS:**

Control Cab with Heat/AC  
Custom cutting capacity lengths available  
Log Infeed Deck (image below)



[www.bakerproducts.net](http://www.bakerproducts.net) | [info@bakerproducts.net](mailto:info@bakerproducts.net) | 573.663.7711 | 800.548.6914 | Like our page 

**GIVE US A CALL OR VISIT OUR WEBSITE FOR MORE INFORMATION!**

# HUGE Price Reduction on Vecoplan Grinders!



**Vecoplan VAZ 2000 M-N**  
~~\$323,000~~  
**\$290,000**

This machine is brand new and still in the crate! Visit PRSGroupInc.com to view a product video.



**Vecoplan VAZ 2000 M-N**  
~~\$312,000~~  
**\$250,000**

Machine is turn key and in excellent condition! Installed in April 2014 with only 6,700 hours of use.



TOMORROW'S TECHNOLOGIES, TODAY

New arrivals weekly, check our website for photos and details on the machines above and more...

Inspect any of these machines under power at our Illinois Facility

**TOLL FREE (866) 546-8864**  
[www.PRSGroupInc.com](http://www.PRSGroupInc.com)  
 email to: [info@pallet-repair.com](mailto:info@pallet-repair.com)

**ClearSpan** fabric structures  
 1.866.643.1010 [ClearSpan.com/ADALP](http://ClearSpan.com/ADALP)

**WE MANUFACTURE - WE INSTALL**  
**WE SAVE YOU MONEY**  
 WAREHOUSING SOLUTIONS FOR ANY INDUSTRY

**Fabric Structures**  
 Natural Light & Low Cost Per Sq Ft

**Hybrid Buildings**  
 Benefits of Metal & Fabric Buildings

**Foundation Solutions**  
 Build Anywhere & Quick Construction

GET **0%** FINANCING FOR **84** MONTHS OR GET A **BIG CASH** DISCOUNT\*  
\*RESTRICTIONS APPLY

USA★

## Mellott

### RUGGED RELIABLE LOG AND LUMBER HANDLING EQUIPMENT

- Experienced and Knowledgeable Service
- Full Inventory of Common Repair Parts with Same Day Shipping
- Accountability - Components used are tested quality parts
- Standard and Custom made equipment for reasonable prices
- In-House Engineering Staff

**PARTS! SERVICE! NEW EQUIPMENT!**  
**Phone 717-369-3125 • Fax 717-369-2800**

Email [sales@mellottmfg.com](mailto:sales@mellottmfg.com)  
[parts@mellottmfg.com](mailto:parts@mellottmfg.com)

Mellott equipment designs have been tested through many years of experience to handle the toughest and most demanding applications.



Log Turner



Debarker



Drop Belt



Log Trough



Live Deck



Tilt Hoist



Bark Conveyor



Operator's Cab



Whole Log Metal Detector

[WWW.MELLOTTMFG.COM](http://WWW.MELLOTTMFG.COM) • VISIT OUR WEBSITE FOR DETAILED PRODUCT BROCHURES

## **STORTI R 35 Gang Saw with M2L High Speed Stacker** *The Perfect Combination for Accuracy, Efficiency and High Production.* **And it Saves BIG on Your Labor Costs!**

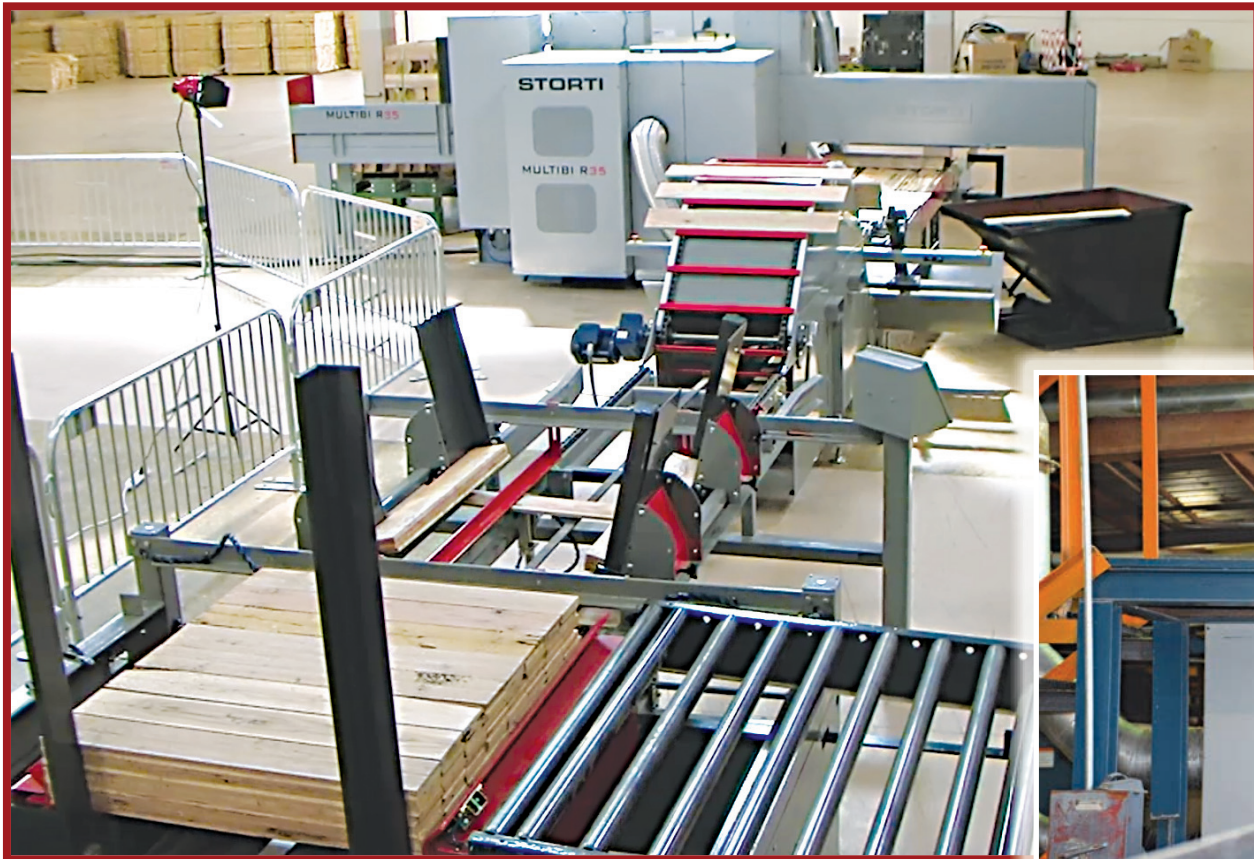

- Accepts 3.5" & 5.5" wide 2, 3 & 4 sided cants
- Auto feed without operator
- Eliminates fine powder saw dust
- Small space requirement



### **M2L 200:**

- Capable of stacking up to 15 layers per minute!
- Automatic Tie Strip Placement option available

## **The Next Big Thing in Up Cut Package Saws!** **STORTI TGS P 500**

- Eliminate the headache of dunnage and pinched packs
- Create a clean and even finished product for your customer
- Cut more packs per day than the current industry standard
- Decrease labor with our auto banding option



Scan here to view a video of this machine in operation.

*For North American Sales:*

**PALLET MACHINERY GROUP**

6496 Landing Road / King George, VA 22485  
 Phone: 540-644-9220 / Fax: 540-663-4081  
 info@palletmachinery.com / palletmachinery.com

*Manufactured By:*

**STORTI**  
 SINCE 1960

Via F. Dioli, 11 / 26045 Motta Baluffi (CR) Italy  
 Phone: 39 0375 968311 / Fax: 39 0375 968310  
 sales@storti.it / www.storti.it

### Sawmill Machinery For Sale

- Planer Line including: Newman 990, 60 Bin Newnes Trim, Sort, Stack
- Nicholson Debarker A5B 17"
- Nicholson Debarker A5A 27"
- Nicholson Debarker A5A 35"
- VK Debarker Dual Ring 18"
- VK Log Centering Units, 17", 22", 27"
- PLC Lug Loaders for 20' Lumber LH and RH
- PLC Lug Loader for 16' Lumber RH
- Linden Log Feeder, 4 Steps
- 2006 Comact Log Feeder 16' w/Infeed Deck, Log Conveyor
- Sawmill 54 Bin Trim Sort Stack 16' Lumber, Comact Push Lug
- Sawmill 49 Bin Trim Sort Stack 16' Lumber, Carbotech Push Lug
- Comact DDM12 Canter Line
- 2003 Optimill DLI Canter, 22" Log, Circular Quad Saws, 10" VDA
- Lundeen RH Stacker for 20' Lumber w/Auto Kiln Stick Handling

**Mackay Sales**  
 BC, Canada  
**604-277-7046**  
 mackayh@telus.net

### EQUIPMENT FOR SALE

- 2000 Caterpillar 924GZ Serial # 00303 w/Log & Lumber Forks ..... \$37,900
- 2002 Caterpillar 924GZ Serial # 00846 w/Log & Lumber Forks ..... \$39,500
- 2006 Caterpillar 924G Serial # 02020 Quick Attach w/Log & Lumber Forks..... \$46,200
- 2012 Precision Dual Chip Loading System w/30 HP Motor & Blower (Like New) ..... \$14,900
- 24" Concave Belt Conveyor 25' Long w/Motor & Drive ..... \$3,400
- 150 HP Cleaver-Brooks Boiler w/ Controls, Propane or Natural Gas ..... \$6,800
- (2) Miner Edgers —  
 - D-53 w/Infeed & Outfeed ..... \$3,600  
 - B-53 w/Infeed & Outfeed (Used less than two years) ..... \$8,500
- 24" Flat Belt Conveyor 27' Long (Hyd. Drive)..... \$2,800
- Mellott 36" Debarker w/Barn Sweep..... \$7,500

Contact Hugh  
 hclark@clarklumbercompany.com  
 or 615-699-3497

# Actual Size Handheld Super-Size Performance

For Lumber, Logging, & Cruising, switch to the handheld that consistently out-performs all the others.

For more info and a risk-free demo call **888.520.1951**

Or go online at [www.eLIMBS.com](http://www.eLIMBS.com)

### BANDSAW WHEELS

- New & Used From 20" to 108" Dia. Steel Wheels.
- For All Makes And Models of Bandmills Including Replacements For Cast Wheels.
- Portable Bandmill Wheels and Components.

Premier Bandwheel & Equipment Ltd.  
 Phone: (604) 591-2080  
 Fax: (604) 591-2835

[www.premierbandwheel.com](http://www.premierbandwheel.com)  
 E-Mail: sales@premierbandwheel.com

### Stock Your Sawmill With The Best Saws — Since 1890!

See our web specials at:  
[www.paynesaws.com](http://www.paynesaws.com)  
**800-752-0627**

### Precut Pallet Stock Hardwood & Aspen

Lumber Resources delivers throughout North America

Call Philippe or Gilles Martel @ 1-866-815-0404 (toll free)  
 Or e-mail: pleblanc@rlumber.ca

418-624-0038  
 fax: 418-624-1008  
[www.rlumber.ca](http://www.rlumber.ca)  
 "Your Lumber Store!"



**WM**

# BOOST PERFORMANCE WITH TURBO 7

**SAVE 10%**  
on any online blades order in October\*

USE PROMO CODE  
**BLADES10**

woodmizer.com/blades10

**doubleHARD**  
HIGH-ALLOY BANDSAW BLADES

**silverTIP**  
CARBON BANDSAW BLADES

### HIGH PERFORMANCE TURBO 7 BLADE IDEAL FOR HIGH HORSEPOWER SAWING

Developed on **exotic hardwoods** in South America, the **Wood-Mizer Turbo 7** blade's unique, **aggressive profile** has more than proven itself in sawing white oak, hickory, ash, hard maple and more. **Boost your blade performance today with Turbo 7.**



© 2015 Wood-Mizer LLC  
\*Offer valid on online orders through 10/31/2015. Cannot be used in combination with any other offers or discounts.

**Wood-Mizer Blades**  
*Innovation. Precision. Performance.*

800.522.5760 | woodmizer.com/blades10

## BRAND NEW McDonough 62" Modular Horizontal Resaw System – IN-STOCK, No Waiting!

Designed for 6' to 16' long lumber. Complete with Infeed Table, Outfeed Table with High Speed Separator System, complete Runaround, Operators Cab and all controls. System is 90% complete and ready to be finished to your mill specifications.





**The Right Way To Go!**  
Quality Sawmill Machinery Since 1888

**715-834-7755**  
WWW.MCDONOUGH-MFG.COM  
EAU CLAIRE, WISCONSIN

## PALLET CUTSTOCK

Northern Dense Hardwood & Aspen Deckboards & Stringers Notching Available

*We Are Now Offering ISPM15 Compliant Heat Treating For Our Lumber*

**Also Available** Anti-Mold/Stain Treatment

**Sagola Hardwoods, Ltd.**  
*For the highest quality & best prices, contact: Steve Shirkey*

Phone: **906-542-7200**  
Fax: **906-542-3524**  
E-mail: [steveshirkey@att.net](mailto:steveshirkey@att.net)

# DTS03 DUAL TOOTH SETTER

First introduced in 1996, retooled in 2003, and still **THE MOST ACCURATE** Dual Tooth Setter on the market. Guaranteed.

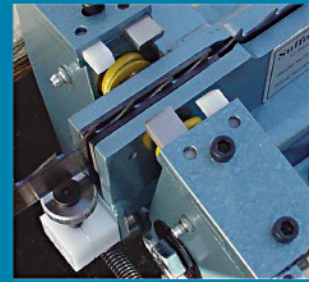

- Equipped with Cobalt up-setting tool bits.
- Sets teeth to within .002 per side.
- Sets from 1" to 2" wide blades.
- Sets from 1/2" to 1-1/4" pitch.
- Hand held Clamp-On Set Gauge included.
- Capable of both increasing and decreasing tooth set.
- Equipped with both Delrin plastic and mild steel down-setting tool bits.
- 3 Blade Stanchion Rollers included.



**DTS03**  
Dual Tooth Setter

**Call 800-234-7297**  
**timberwolfbandmillblades.com**



# Magnum LT. Changes. Everything.

We asked ourselves "How can we make the Hurdle mill better? The answer was simple - build the best carriage on the planet."



Designed with the latest engineering technology for maximum performance and simplicity.



- ★★★★★
- Simplest carriage ever made
- Tougher - holds massive logs
- 29" dog openings
- 20% more dogging force than others
- 40" knee openings
- 1/2" thick tubular frame
- Variable Taper
- Adjustable Chain Drive
- Less maintenance - fewer moving parts
- Available on the Hurdle Heavyweight Mill

**CALL US NOW!**  
901.877.6251

[www.facebook.com/HurdleMachineWorks](http://www.facebook.com/HurdleMachineWorks)  
 [www.youtube.com/HurdleMachineWorks](http://www.youtube.com/HurdleMachineWorks)

**PATENT PENDING**  
HURDLE MACHINE WORKS, INC.



MADE IN USA

## Engines, Power Units, Gen-Sets

Detroit Diesel, S53, 71, 92, 60  
Remanufactured & USED  
**New & USED Parts**  
Twin Disk & Rockford Clutches & Parts  
Power Unit Radiators & Gauge Panels  
*Specializing in*

**DETROIT DIESEL**

## Leid Diesel Service

**Now 3 Locations to serve you:**  
267 Green Hill RD. - Newville, PA 17241  
**717-776-7725**  
N12574 Cty. Hwy. M - Thorp, WI 54771  
**715-669-3799**  
2952 W. Carson City Rd. - Sheridan, MI 48884  
**616-754-5871**

## PACIFIC TRAIL MANUFACTURING INC.

A difference that will keep you cutting!  
**888-910-SAWS**

Making quality bars here since 1991

- NEW BARS
- WE REPAIR
- ALL MOUNTS
- SLASHER BARS
- DOUBLE END

Hand made from 500bhn alloy steel. Harder than hell but will not break!



w  
w  
w  
.  
p  
t  
m  
i  
.  
n  
e  
t  
  
i  
n  
f  
o  
@  
p  
t  
m  
i  
.  
n  
e  
t

All your 3/4" pitch needs.  
Direct from us, the manufacturer!

### Model 7 Saw Grinder

**\$525**  
w/Grit Wheel

Vertical Edgers  
Headsaws  
Scraggs  
Edgers



"The Saw Boss"

**\$595**  
with Diamond Wheel

Handle rotates 360° to the best operating position.

Tension Lever and Guide Pin assure accurate grinding and easy movement.

### The Shorthorn Saw Grinder for Headsaws Scraggs Edgers

Powerful 8 amp motor

**\$580**

Roomy Handle



Motor pivots on base to quickly set lead angle.

**Jones Saw Tools** 812-354-6981 or your local dealer.

## PHASE CONVERTERS

RUN 3-PHASE EQUIP. FROM SINGLE-PHASE POWER SOURCE

**STATIC CONVERTER**

EXPERTS IN PHASE CONVERTER SYSTEMS SINCE 1965

**ROTARY CONVERTER**



**3-PHASE POWER TO RUN YOUR WHOLE SHOP**

CNC/PLC AVAILABLE FOR VOLTAGE SENSITIVE APPLICATIONS



**STATIC:**  
2/3 RATED HP MOTOR LOADS ONLY  
1/3 TO 50 HP

**ROTARY:**  
FULL RATED HP / OUTPUT  
RESISTIVE & MOTOR LOADS  
FRACTIONAL TO 500 HP OR MORE

CALL NOW!  
**1-800-962-6976**

**PHASE-A-MATIC**™

[www.phase-a-matic.com](http://www.phase-a-matic.com)



**FOR SALE**  
**Pallet Manufacturing Plant**  
 in Central Michigan

*Good Family Business  
 with Good Customer Base!*

Call 989-268-3074  
 or 231-928-6320  
 Fax 989-268-5357



**BUYING** Red Aromatic Cedar Logs

By the foot or by the ton all year.

**Call For New Pricing!**

MILLER'S CEDAR Call Allen . . . Let Ring  
 HORSE CAVE, KENTUCKY **270-786-4316**

**WANTED**  
 48 x 40's  
 Broken and repaired  
 Calumet Pallet

Contact Jeff: 219-932-4550

**PRECISION-BALANCED  
 HOG ROTORS**

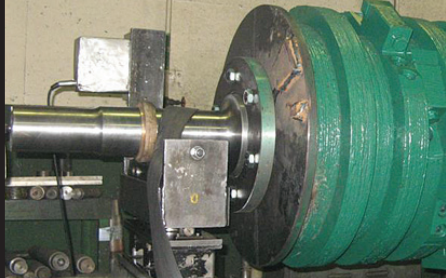

ELLISON SALES, INC.  
 Toll-Free: 888-244-0161  
 dan@ellisonsales.com



**BAND WHEELS!**

✓ **Blades Not Tracking?** ✓ **Bad Cuts?**  
 ✓ **Worn Crown?** ✓ **Short Blade Life?**

We've been re-crowning, re-banding wheels and manufacturing new wheels for OEM band saw suppliers for years! We know what works!

**QUALITY WORK • EXPERT ANALYSIS • REASONABLE PRICING • PICK UP & DELIVERY**

**PLUS!** — New Sheaves (single or multiple grooves) and New Wheels & Hubs (20" to 40" dia. and 1" to 5" blades)

We make your operation run smoother — at an economical price!

**Resaw Owners Can De-Dust Boards As They Saw**  
 With "Ram Jet" Replaceable Insert Guides

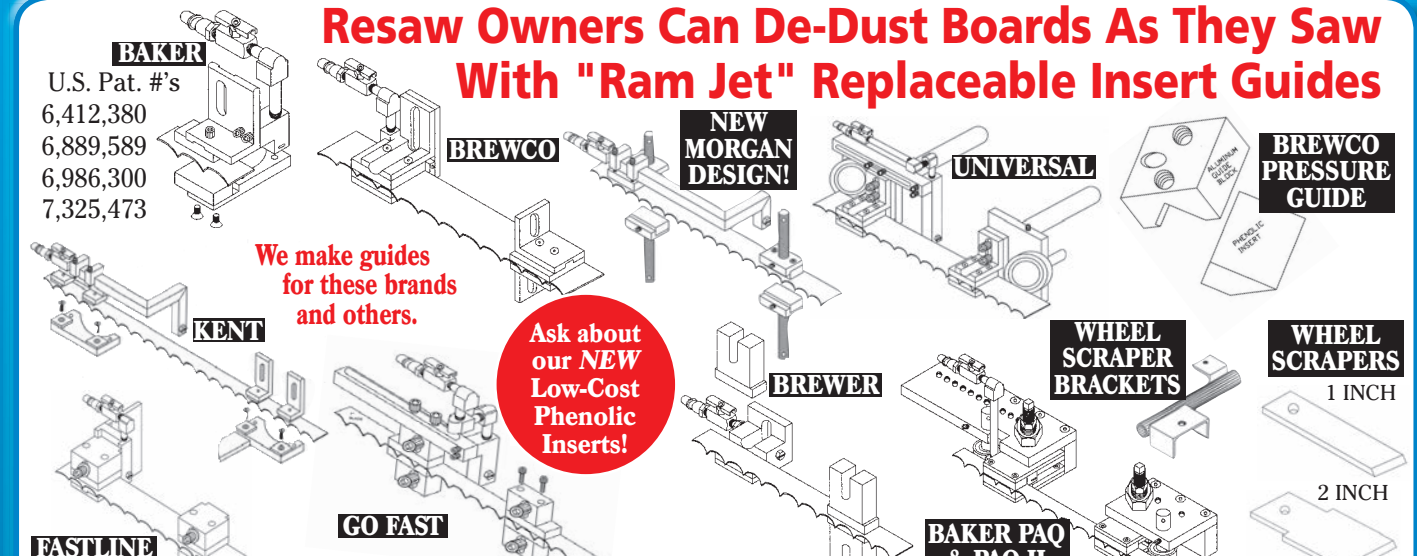

U.S. Pat. #'s  
 6,412,380  
 6,889,589  
 6,986,300  
 7,325,473

We make guides for these brands and others.

Ask about our **NEW Low-Cost Phenolic Inserts!**

**www.tri-starmetalsinc.com**

- NEVER buy another set of guides — just replace inserts!
- NO board deduster or hand dedusting needed
- NO modifications to your saw required. Just dust-free boards as you cut!

For details, call Ed  
**800-685-2899**  
 or 270-281-4500

**TRI-STAR METALS INC.**  
 1415 East Parrish Ave. • Owensboro, KY 42303  
 FAX: 270-281-4511 E-Mail tsmi1@roadrunner.com

MADE IN USA

**THERE ARE MANY REASONS WHY YOU  
 NEED TO KNOW WHAT YOUR MILL IS WORTH**

**EQUIPMENT & INSURANCE APPRAISALS • MARKETING PLANS • LENDERS**

*You have the right to choose your insurance appraiser!*

See Our New Appraisal Website Today! [www.kittrellappraisals.com](http://www.kittrellappraisals.com)  
 See Our New & Easy To Use Equipment Site! [www.kittrellsawmillbrokers.com](http://www.kittrellsawmillbrokers.com)



**KITTRELL APPRAISALS**  
 Forestry Equipment and Consultation  
**931-698-3342**

**BE SURE YOU SPEAK WITH  
 JACQUELINE KITTRELL,**  
 OWNER, APPRAISER, AUCTIONEER,  
 REAL ESTATE BROKER, CAGA



info@kittrellappraisals.com • Fax: 931-231-1051 • Office: 931-797-6284 • Firm #5745

**Turn Wastewood Into Profits!**

Sell your wood at \$300 or more per cord with the **WOOD-PAKer**, a high-production, easily operated shrink wrapping machine.

7 Models • Financing Available

**B & B Manufacturing**  
 e-mail: [bbmfg@sprynet.com](mailto:bbmfg@sprynet.com)  
<http://home.sprynet.com/~bbmfg>

**800-654-5320**

**WANT TO BUY!**

Poplar, Ash and Cedar Grade Logs

Call Thomas  
**606-802-9512**

# New Meadows Carriages To Fit ANY Sawmill

**112 Years of Experience**  
**Makes Meadows The Perfect Choice To Design *Your* Next Carriage**



**Meadows Center Dogging Carriage/Center Dogging Headblock**

- Carriage frame lengths from 10 feet and up. Openings from 33" to 44"
- Center or side mounted hydraulic board dogs with push button controls.
- Hydraulic "on-the-headblock" turners available, push button controls.
- Setworks with hydraulic drive, electric controls & rotary encoder or linear temposonic rod.
- Carriage wheels from 6" to 10" diameter for "T" or hex rail systems.
- Hydrostatic carriage feeds and hydraulic power sources also available.

**MEADOWS MILLS, INC.**  
**800-626-2282**



www.meadowsmills.com • e-mail: sales@meadowsmills.com



Profile Ground Tooth  
**TIP TO TIP**

Wood-Mizer's SilverTip blade is a **TOP-PERFORMING**, economical blade for primary and secondary wood processing.

**Jerry's Resharp Incorporated**  
**270.757.1000**  
 14145 US Highway 431  
 Central City, KY 42330

The Wood-Mizer quality you love. The convenience you need.

## OUR UNIQUE & INNOVATIVE WOOD DRYING PROCESS DELIVERS RESULTS



### BRIGHTER LUMBER MEANS HIGHER SALES

Nova Dry Kiln's innovative technology offers a unique drying method that is kinder and gentler to the wood drying process. This process results in brighter lumber and gives our customers higher sales. Nova Dry Kiln builds and designs medium and large kilns ranging from 5,500 to 120,000 or more board feet.

### TIMBER DRY MANAGEMENT CONTROLS OFFER FLEXIBILITY AND EASE OF USE

When using the Timber Dry Management System kiln operators have a straight forward, simple to use, flexible program. Kiln operators can make instant changes on the touch screen interface that is provided for each individual kiln. This drying control technology uses the exclusive proven and cost-saving Nova Dry Kiln methodology.

### CONTACT US FOR FURTHER DETAILS

We provide turnkey construction services along with excellent customer service as part of our dry solutions. Call our technical staff today for further information about Nova Dry Kiln and our Timber Dry Management system.

### INNOVATIVE TECHNOLOGY SAVES MONEY ON UTILITIES AND DEGRADE

Our kilns not only save money on utilities but our customers experience end results of only a 1 to 1 1/2% degrade. Using the combination of a thermal blanket created from our heated floors, with fans that do not reverse rewetting the lumber surface, also moisture is not reintroduced into the drying chamber for humidity control or conditioning, to the aluminum-lined walls that offer a superbly insulated chamber, the Nova Dry Kiln saves you money on your utilities and provides you with a superior end product and in most cases only a 1 to 1 1/2% degrade.



Ask about our  
 Pallet Treating Kilns &  
 Firewood Kilns

**1-502-409-4539**  
 www.novadrykiln.com • e-mail: info@novadrykiln.com



**RIPSAWS FOR SALE**

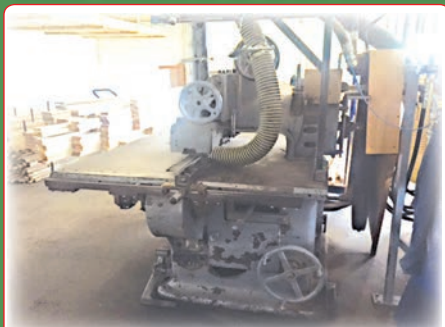

**Mattison Model 207  
Straight Line Ripsaw**  
Hydraulic powered.  
Good condition.....  
**\$2,750 OBO**



**Diehl Model MR90  
Multi-Ripsaw**  
40HP motor, 12 blades.  
Good condition.....  
**\$2,750 OBO**

Call Ray 440-693-4220 (OH)



**NEW PRECISION  
6x6 Chip Screen**

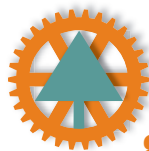

Ben Jones Machinery  
Div. of Dickert Enterprises, Inc.  
Industry's Most Trusted Source

**800-241-8983**

See more equipment at  
[www.benjones.com](http://www.benjones.com)

**Pallet Recycling Solutions from Smetco...**



Stringer/  
Board  
Splicer



Notchers



Trim Saws



Turntables



"Quick-Stack" System

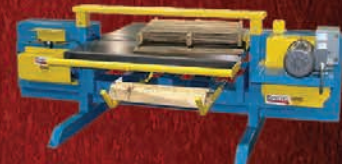

Dismantlers



Single End  
Trim Saw



Stackers

SMETCO also makes a complete line of repair and recycling equipment.



**Sorting Systems**

**SMETCO, INC.**

Pallet Handling Systems

PO BOX 560  
AURORA OREGON 97002

Phone: 1-800-253-5400

Fax: 503-678-3095

[www.smetco.com](http://www.smetco.com)

[sales@smetco.com](mailto:sales@smetco.com)



"Your trusted authority for  
sawlog marketing information"

**We Specialize In Current Log Prices!**

**Hard & Softwood Log Prices**  
Log Prices For New England, NY & PA  
Veneer Logs | Grade Logs | Pallet Logs

[www.TheLogStreet.com](http://www.TheLogStreet.com)

Celebrating  
25 YEARS!  
1989 - 2014



**Bandit 1850**

**LEERAY & LUKE HORTON**  
**218-372-4232**  
E-Mail: [l1sales@frontiernet.net](mailto:l1sales@frontiernet.net)

# Your Most Reliable Source for New, Used & Customized Machinery. Call Mona Tracy Today!



The **RUN-A-GADE** Bandsaw Pallet Disassembly System



**TRIO**  
3-Head

## **BANDSAW DISASSEMBLERS!**

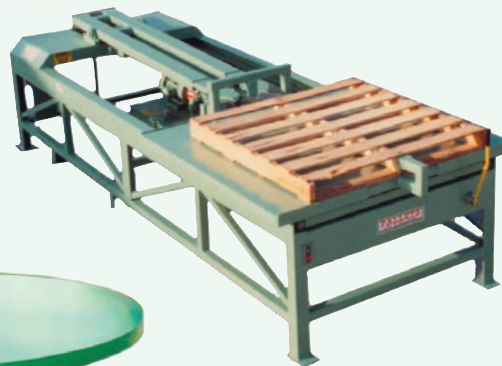

**SOLO**  
Single Head

## **DISC TYPE DISASSEMBLERS!**



**MARK I**  
Bandsaw Disassembler  
Make it a complete system with a round table



**Manual Chop Saw**

## **LUMBER SAVERS!**



**TRIM TRAC**  
End Trim Saw



**High Speed Pop-Up  
Cut-Off Saw**



**SN20 Automatic Notcher**

## **NOTCHERS!**



## **BLOWERS!**



**UNIVERSAL**  
MACHINERY SALES, INC.

Call Mona Tracy

**Toll Free 1-855-298-8890  
or 812-298-8090**

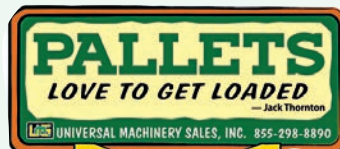

- Corner Rounder
- Chamfer
- Unstubber
- Pallet Sizer
- Round Tables
- Specialty Machinery

www: [universalmachinerysales.net](http://universalmachinerysales.net)

E-Mail: [sales.universalmachinerysales@gmail.com](mailto:sales.universalmachinerysales@gmail.com)

**Leasing & Financing Available**

# The Most Innovative Equipment is a Phone Call Away..



**NEW  
4-Head  
Design!**

## Low Profile BAND RESAWS

Single & Multi-Head Models  
Available with or without return  
Hands-free return eliminates one operator  
Save labor - Save money!



## NEW Multi-Head TRIM SAW

2, 3, 4 or 5 head models  
Adjustable heads with variable speed, chain feed  
drive motor with starter  
20" x 40-tooth carbide blades  
Quick change adjustable to length

## NEW! ANGLE CHOP SAW

Cuts 0° to 45° on a 2x8  
and 0° to 40° on a 2x10  
Fast Cycle  
Easy to set up and operate  
Guarded blade for safety



## Robo Chop UPCUT SAW

Automatic push feeder,  
30,000 B. F./shift. Stacks  
boards 5 high & up to 16  
wide. Up to 16 ft lengths



## Military BAND NOTCHER

Fully Adjustable notch-length of board  
Option: Double groove notch and 14" blade  
to cut board into two strips



## Hopper-Feed BLOCK SAW

Cuts 2x4 & 4x4 blocks from 24" drops  
30 hp, 3-phase motor/starter



## Self Dumping STEEL HOPPERS



## REPAIR BARS!

Call for Pricing!



## STAKE MACHINERY

## SCISSOR LIFT



2,000 lbs. to 8,000 lbs. per your specifications

# Strapping Prices Remain Lower Than They Have In Years!

**But we all know...Things Change.**



Stock Up Now While We Know What The Price Is!



Transportation is more affected by the weather than it's ever been. **Stock up NOW!**

Just need a little steel?  
**1 Skid for \$775**  
to the Midwest

Shipping from of USA.



**Tifton, Georgia**  
P.O. Box 7552, Tifton, GA 31793

**800-362-9332**

Call Henry, Verna, Susan, Sandra, Sarah, Amy, Jennifer, Emily, Gracelyn!

& Check by Fax or Phone

## THINKING AUCTION?

Call: **800-432-1922**

**WAUSAU/AUCTIONEERS**

SALES CORP. P.O. BOX 1311 • WAUSAU, WI • 54402-1311

PH: (715) 536-1955 • (800) 432-1922

"Forest Products Specialists"

**Everyone has surplus equipment that could be earning CASH.**

Our equipment brokering service is the way to go! Let us handle the hassles and headaches for you.

**You can benefit like others... Call us today to get started.**



**Check Us Out!**

Call

**Jacqueline Kittrell**

**931-698-3342**

[www.kittrellsawmillbrokers.com](http://www.kittrellsawmillbrokers.com)

**LT 300 Wood-Mizer w/Off Load Conveyors**

Plus

**Lots More!**



Located in Washington  
Ad #: 16836

**\$85,000**

**SAWMILL EXCHANGE**

**800-459-2148**

[www.sawmillexchange.com](http://www.sawmillexchange.com)

## WANTED TO BUY

- #2 Pallet Lumber
- Line Bar Shims
- Hard Maple 4 x 6's, *Special Pricing*
- Cross Tie Siding
- 4 x 6 Cants

## FOR SALE

- 40" Recycled Runners

**Elora Pallet Shop** Elora, TN  
**931-469-5558**

## K.M.C. Model 882HD Double Bandsaw



*We can provide the best machine to meet your application and production requirements!*

- ✓ Self Adjusting Catty Track Hold Down System
- ✓ Harden & Baked Chrome Steel Paddle w/Lubrication System
- ✓ 18" Min. Length
- ✓ 3/8" to 6" High Material Climb from Blade Height — Optional 12" Climb
- ✓ Max Cut Height 8"
- ✓ Max Cut Width 8"

*OPTIONAL:* Digital Readout • Rubber Belt or Harden Steel Chain Feed • Floating Air Guide • Head Drive, Electric, Hydraulic or Lineshaft • Hydraulic Power Unit

**717-859-4977**

**KEYSTONE MACHINERY CORPORATION**

20 Cocalico Creek Rd. • Ephrata, PA 17522

[www.keystonemachinery.com](http://www.keystonemachinery.com) Fax: 717-859-4979

**IN THE MARKET FOR USED/REFURBISHED HOGS... AND MORE?**  
**CHECK OUT OUR INVENTORY FOR CAN'T MISS BARGAINS.**



**Rebuilt Montgomery 42PM-HZF,  
10302.01**



**Helle 3-Block Carriage,  
10319**



**Precision 58in 6K ChipPack,  
10317-1**



**Montgomery 57XLKC,  
10225-3**



**Montgomery 18HD Hog,  
10318-1**



**Montgomery 50PM-HZF,  
10294-2**



**C-200-Low RPM Grinder,  
10314-1**



**2-Saw Vertical Edger,  
10320**



**Montgomery 26HD40 BloHog,  
10054-1**



**West Salem 2822BH,  
10295-1**



**Morbark 48in ChipPack,  
10315-1**



**Morbark 58in 3K ChipPack,  
10313-1**



**Montgomery 45CSKC,  
10076-1**



**40x64HZF 500hp Horiz Hog,  
10146-1**



**75hp Champion 15x22 Hammermill,  
10279**



**24-Unit Peerless Bin,  
10312-1**

**Already have a Montgomery Hog?  
We supply all the parts you'll need!**



**ELLISON SALES**  
**Toll-Free: 888-244-0161**  
**E-mail: dan@ellisonsales.com • www.ellisonsales.com**

**Portland,  
Oregon**

# CLEEREMAN SAWMILL MACHINERY

Why has **CLEEREMAN** Sold **1050** Carriages?

The Answer is Simple...  
**QUALITY & SERVICE!**



## 12 MODELS

A CARRIAGE TO FIT YOUR OPERATION!

COMPLETE GRADE & TIE MILL PACKAGES



Patent Pending

# LUMBER PRO



## CLEEREMAN

Not just Carriages!

- CARRIAGE DRIVES  
Hydrostatic & Electric
- BAR TYPE LOG TURNERS  
2500 - 3500 lbs.
- AIRBAG & HYDRAULIC CABLE TENSIONERS
- SAWYERS CABS & CONTROL CABS
- CUSTOM MATERIAL HANDLING SYSTEMS



Heavy Duty Double Cut Band Mill  
That is Sweeping the Industry.

- 54" or the New 62"
- Reduces Manpower
- Adds Flexibility from 4/4 - 12/4 Lumber, Beams, Cants, Cross Ties or EVEN as a Resaw!
- Lower Initial Installation Cost
- Unmatched Accuracy

All Machines are Cleereman Quality Throughout.  
You Get the Best Machines Backed by the Top Service  
in the Industry - Call Cleereman Today!

INFO@CLEEREMAN.COM  
WWW.CLEEREMAN.COM

PHONE: 715-674-2700  
FAX: 715-674-7002  
5500 PINE ST., NEWALD, WI. 54511



Stop By and Check Us Out  
At These Upcoming Shows:

Paul Bunyan Show  
Oct. 2-4th • Cambridge, OH

NHLA Convention  
Oct. 7-9th • Nashville, TN

## PARTS & SERVICE

Forest-All, C.M.C., C.S.P., <sup>35 Years</sup>  
Hilltop Equipment <sup>Experience!</sup>

DICK NOLIN SAWMILL SERVICE  
**603-724-3942**

## Bulk Box & Crate Care

Our reinforcing corners & plates  
are the answer for added

• Protection • Durability • Strength

- For New or Used items
- Apply by nail gun or hand
- 8 Sizes available
- Tough 20-gauge galvanized steel

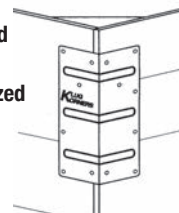

**KLUG KORNER**  
800-471-5060 or  
269-657-6858  
www.klugkorners.com

## Mixed Hardwood Pallet Cutstock

- 1/2" - 1" Thickness
- 3 1/2" - 5 3/4" Width
- 30" to 60" Length

Pine  
Also  
Available

**\*\* Stringer Orders Wanted \*\***

Call Todd or Lisa: **931-296-1455**  
trichardson@waverlywood.com

Waverly Wood • Waverly, TN

## Need Parts to Fit Your Morgan Saws?

### MILITARY BAND NOTCHER



- 5hp motor
- Hydraulic adjustable feed
- Indexable carbide cutters
- Adjustable width & height
- Can custom build

## Sawmill Supplies & Equipment, LLC

- Board De-Dusters
- Multi-Head Trim Saws
- Product & Waste Conveyors

Office: **318-994-2116**

www.sawmillsupplies.net

E-mail: sawmillsupplies@centurylink.net

Call Mona Tracy  
**1-855-298-8890 (toll free)**  
sales.universalmachinerysales@gmail.com  
universalmachinerysales.net

Still Building the ORIGINAL  
Low Profile Single Resaw



PEERLESS  
14 Unit  
Bins



Ben Jones Machinery

Div. of Dickert Enterprises, Inc.

Industry's Most Trusted Source

**800-241-8983**

See more equipment at  
www.benjones.com

## Third Man Nailer



Call for  
FREE DVD

**Jig & Stacker**

Build Pallets Faster  
and For Less Money!

RT Pallet Equipment

**306-737-3310**

email: roberttrembley@hotmail.com

www.rtpalletequip.com



View the video  
on our website.

BOX 29 Imperial SK  
S0G 2J0 Canada



## EFFICIENTLY REMOVE BY-PRODUCT WITH PENDU BLOWERS & BARK CONVEYORS

### BLOWERS

- 4 and 6 blade fan designs
- Quality steel components
- 18", 26", and 42" models
- Alloy steel shafts, heavy-duty ball bearings
- Quiet operation



### BARK CONVEYORS

- Easily move secondary products: bark, sawdust, shavings, etc.
- Straight line or any combination of degree angles
- Can be elevated up to 35° for material depositing into trucks, hoppers, or piles



Stackers Trim Saws Gang Saws Scragg Mills Edgers  
**800.233.0471 717.354.4348 www.Pendu.com**

# BELL'S

## FIREWOOD PROCESSORS

Paul Bunyan Show  
 Oct. 2-4th  
 Cambridge, OH



- CAT Turbo Diesel Engine
- 54" Circular Saw
- 23.5" Diameter Capacity
- Single Joystick Control
- 42 Ton Splitter Cylinder



Many Models  
 and Options  
 to Choose From



Please Call for Details  
**1-888-995-1965**

or visit us online  
[www.bellsmachining.com](http://www.bellsmachining.com)

Financing Available

# START BUILDING

*your own* BUSINESS

**DISCOVER HOW OWNING A WOOD-MIZER PORTABLE SAWMILL IS AN INVESTMENT THAT PAYS.**

Countless Wood-Mizer owners save money by sawing their own lumber. Take the next step in your decision to make a Wood-Mizer sawmill an essential piece of machinery in your future. Call today for a **FREE** catalog and DVD.

**Start Building Your Own Business with Wood-Mizer.**

**Wood-Mizer**

800.553.0182 | [woodmizer.com/biz](http://woodmizer.com/biz)

© 2015 Wood-Mizer LLC \*Prices subject to change without notice.

**NEW** Like us on Facebook  
~ New Specials Often!

# Great Buys On Pallet And Sawmill Machinery!

**Large Selection  
of used equipment  
& misc. parts**



**Brewco Single  
w/Return**

**EDGERS**

Baker Slab  
Morgan Slab  
Miner 4" 2-Moveable  
Fastline 8" Slab Edger  
w/Tailer

**BAND SAWS**

Baker A Gas  
Morgan Single  
GoFast Single w/Gas  
Kent 12"  
Baker A Line Shaft  
Wood-Mizer 5-Head  
Baker 4-Head  
Fastline 4-Head

**NOTCHERS**

Newman Double

**DISMANTLERS**

Disc Style  
Trace Trio

**SAWMILLS**

Tipton Scragg, Complete

**Handset Mills**

HMC Mill  
Edmiston 4 Head  
Block  
Helle w/Genset  
Forstall Mill  
Log Master LM-6  
Frick O1 Hydraulic  
Wood-Mizer LT40  
Electric  
Jackson 2-Head  
Block  
Meadows #2 Handset

**TRIM/  
CHOPSAWS**

Pop Up Saws  
Morgan 2-Saw  
Cornell Chop Saw  
West Plains Chop  
Brewer Chop Line  
Morgan Chop

**NAILERS**

2000 GBN Excalibur  
Pallet Chief II  
Pallet Chief 170"  
Gap 960  
Viking® Duomatic

**DEDUSTERS**

Brewer  
Roblin  
GoFast

**CHIPPERS /  
GRINDERS**

48" Precision Chip  
Pack, 3 Knife  
58" Morbark  
6 Knife Pac  
84" Precision Chipper  
Montgomery Hogs  
Challenger Horizontal  
Arasmith 50-48 HSS

**DEBARKERS**

Morbark 636  
Manitowoc Flail  
Portable & Ring

**GANG SAWS**

Cornell 500 B  
Brewer 8112 w/Sizer  
Cornell CLB  
Single Arbor w/Sizer

**MISC.**

Barn Cleaner  
Chamfer Machine  
Blowers, Many Sizes  
Chip Screens  
Yates A-62 4 Head  
Planer  
Baker Runaround Sys  
Single Head Planer  
250 KW Genset  
Timesaver Sander

Industrial Plywood  
Cutter  
Package Saw  
Stationary  
Cornell 8' Board Stacker

**ROLLING STOCK**

W-14 Case Loader  
Case Dozer 1550  
Barko 80 Loader  
Clark Forklift  
Bandit Chipper w/Loader



**Morgan Chop -  
All Air**



**Miner Edger**



**Complete  
Tipton Scragg  
Merchandizer &  
Cut-up Line**

*Many Decks, Unscramblers and Conveyors*

**WANTED**  
Any Sawmill - Pallet Mill Machinery.  
**Call L&L Today.**

**LEERAY & LUKE HORTON**

**218-372-4232**

8948 Market St., Sturgeon Lake, MN 55783

E-Mail: llsales@frontiernet.net

[WWW.LLSAWMILL.COM](http://WWW.LLSAWMILL.COM)



"Authorized Dealer" for



*Armstrong*

**U.S. Blades** is your single source supplier of high quality knives, saws and related maintenance supplies for Sawmills & Chip Mills. With locations to serve mills throughout the Southern wood belt to the Northeast, U.S. Blades is here to support the Forest Products Industry providing new products as well as repair services.

**U.S. Blades** knives and saws are "Feared By Trees Everywhere."

**U.S. Blades** also has field service technicians for installation and service of all Armstrong equipment with many years of Armstrong parts and equipment knowledge that will benefit our customers.

**Armstrong SDSC Territory Map**  
Shaded areas of this map represent U.S. Blades "Authorized" selling region.



Stocking Locations for "Genuine Armstrong Parts and Equipment"

**LOCATIONS AUTHORIZED TO SELL:**  
Florence, SC • Hampden, ME • Meridian, MS



[usblades.net](http://usblades.net) • 800-862-4544

**WV MINE TOOLS & SERVICE, INC.**

**WE ARE AT THE  
CUTTING EDGE  
OF YOUR  
BUSINESS!**

Try Our Popular  
**SABER INSERTED  
CARBIDE SAW BIT.**

Only \$2.45 per bit!



**FREE SAMPLES!**

▶ Dressing Sticks  
for wheels...  
\$6.00 ea.

▶ \$75.00 for 4 inch  
Diamond Jockey Wheels

**Call TOLL FREE  
888-291-5956**

**WV MINE TOOLS & SERVICE, INC.**  
PO Box 402, MT. Morris PA 15349  
weaver399@msn.com

**The Leader In Chain Bar Repairing Since 1961**

**: Celebrating 50 Years :**

Cut off bars for bundled lumber and cut off applications  
*We repair all types of bars and offer custom manufactured bars  
for all aspects of the wood products industry.*



**CHAIN BAR  
REPAIRING**

**CALL TOLL FREE  
1-877-SAW BARS (729-2277)  
or 503-774-4266** [www.chainbar.com](http://www.chainbar.com)

Email: [chainbar@comcast.net](mailto:chainbar@comcast.net)  
BILL DAVENPORT • 5425 SE Johnson Creek Blvd. • Portland, Oregon 97222

**CALL FOR  
PRICE  
QUOTES**

## Need to Keep Your Current Equipment Running?

# Count on Brown...

During tough times, it's important to maintain the equipment you own, reduce your downtime and be more profitable.

**Brown's Low Prices, First Quality Products & Superior Service can help!**

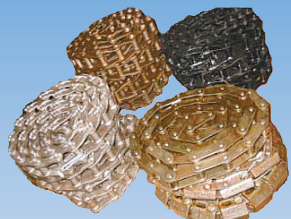

Chains (All Kinds)



Power Drive Units

New/Rebuilt Speed Reducers



Pillow Block/Flange Bearing Units



Sprockets (Cast, Steel & UHMW Plastic)

KEEPING YOUR OPERATION RUNNING SMOOTH

FOR OVER 48 YEARS



800-748-9801

Fax: 870-246-8044

www.brownmachinery-supply.com

P.O. BOX 9, ARKADDELPHIA, AR 71923 • info@brownmacsupply.com

## DEBARKER TEETH

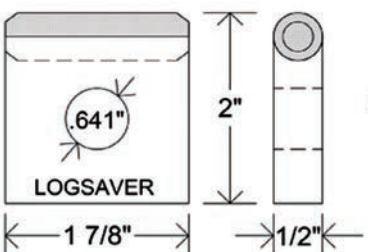
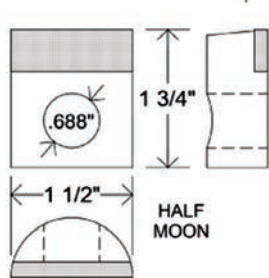
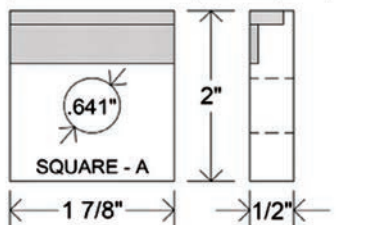
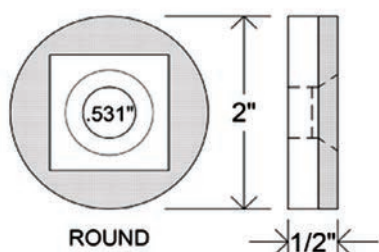
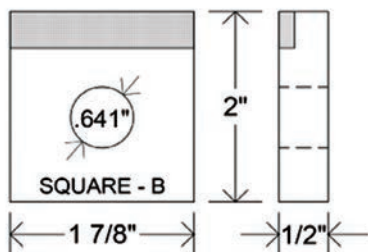

All teeth are carbide-tipped.

See our website for more sizes.

**Universal Wearparts, Inc.**



142 Old Hwy. 98 West  
Tylertown, MS 39667  
800-647-8440 • 601-876-3442  
Fax 601-876-2342  
sales@universalwearparts.com  
www.universalwearparts.com

## NEW MODELS AND OPTIONS NOW AVAILABLE!

Longer Models  
Deburing Side Brushes • Adjustable Fences

**The GoFast Board Deduster features a simple, proven design to reduce sawdust headaches on boards.**

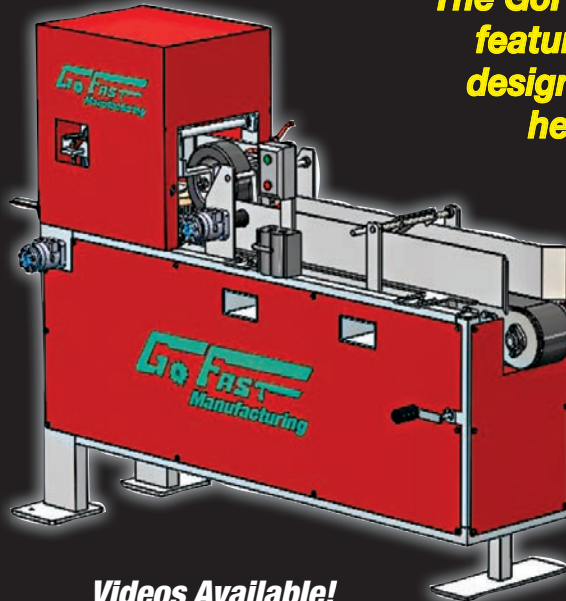

Videos Available!

- Use on any bandsaw (single or multi-head)
- No vacuum system needed!
- Uses (2) low-cost steel brushes
- Sweeps dust to the side to an exhaust port for easy removal
- Board Knocker Knocks frozen boards apart to prevent stalls

## Fast Production of Pallet Stock, Grade Lumber or Slab Recovery

**GoFast Band Resaws are Better by Design!**

- Single or Multi-head models to fit your needs.
- Gas or Electric / Single or 3 Phase
- Easy blade tracking
- Simple 1/8" to 6" thickness adjustment
- Self-contained hyd. variable feed — 0-130 FPM with turn of a dial

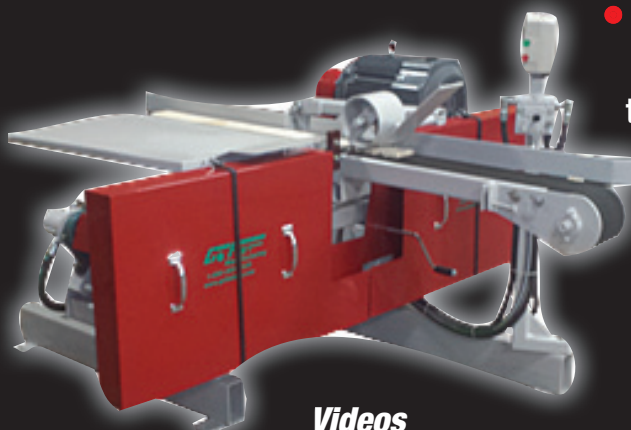

Videos Available!

Be Sure To Check Out

Our New Website!

www.gofastmfg.com

1-800-854-7439



E-Mail: sales@gofastmfg.com • Fax: 920-227-1961

We Have New and Refurbished Units Available

Resaws • DeDusters • Chopsaws • Grade Systems • Parts

# LumberLine Laser



## Now Available In Green!

24 month warranty  
24 hour repair turnaround

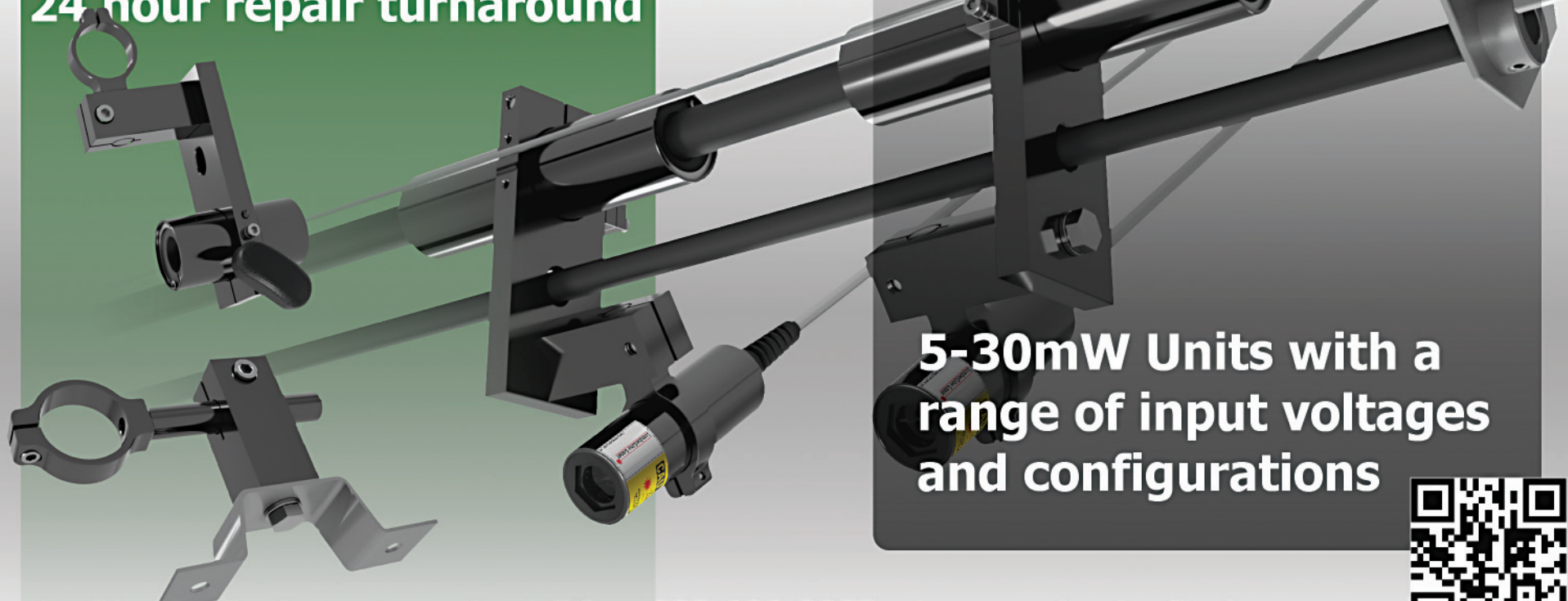

5-30mW Units with a  
range of input voltages  
and configurations



sales@lumberlinelaser.com | toll free 855-686-3077 | www.lumberlinelaser.com



Aggressive • Clean Cutting • Sharp Out of the Box

# MAXIMIZE YOUR MILL



WITH



Precision Ground Teeth • Tight Tolerance Balanced Set • Induction Hardened • High Carbon US Steel

877.366.1696  
www.WoodMaxxBlades.com

### STAKE POINTERS FOR SALE

Keystone Machinery Corp.  
Ephrata, Pennsylvania

717-859-4977

### Short Studs & Pallet Cutstock

KD HT HF/DF/SPF 1x4, 1x6, 2x4, 2x6  
Any length Cutstock. Flatbed  
delivery from our New Plymouth,  
Idaho manufacturing plant.

Also: Green 1x4, 1x6 MRR

Call 1-800-447-3792

e-mail: tjforest@gmail.com

### SAVE \$\$\$

Our metal connector plates repair  
wooden pallets to a like-new condition.  
High quality, superior strength.



Ready to Ship!

PALLET REPAIR SYSTEMS, INC.

866-546-8864

Fax: 217-291-0008

www.pallet-repair.com/alp

# UNBEATABLE PRICES ON NEW & USED MATERIAL HANDLING EQUIPMENT!



Refurbished  
62 Unit Bin



Refurbished Prentice 310E  
Knuckleboom

**NEW Motors  
& Gear Reducers in Stock!**  
Hyundai Electric Motors with 3-year Warranty!!  
World Wide Gear Reducers with 3-year Warranty!!  
**Check with us first —  
We have the lowest prices around!**



Refurbished  
24 Unit Bin



Refurbished  
30 Unit Bin



Bio Mass  
Burners



New Single, Dual or Triple  
Truck Loading System



New & Used  
Belt Conveyors



Assorted  
Cyclones



New & Used Chain Decks  
— **In Stock!**

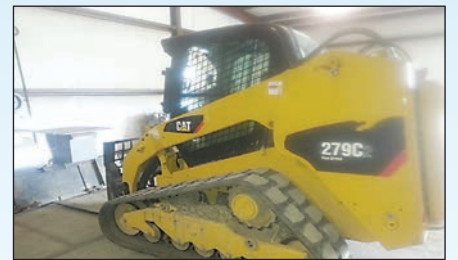

Caterpillar 279C Bobcat  
w/Forks & Bucket



12' x 48' MEC Triple Pass  
Drum Dryer



Assorted  
Blow Pipe



VP400 4 Station Bagger  
-**Barely Used**  
(Trade Show Model)



Self Leveling  
Hopper Feeders



6' Pallet  
Wrapper

## COMPLETE PACKAGE DEALS!!

- COMPLETE CHIP MILL - 90 Ton/ Hr!!!
- COMPLETE PELLET MILLS & COMPONENTS
- BARGE LOADING FACILITY  
100+ Acres w/ industrial buildings available.  
Located on TN River
- WHOLE TREE CUT UP LINE - 52" BLADE
- COMPLETE USNR 18 BAY GRADING LINE



Pellet  
Cooler



Dry Kiln & Hurst Gas Boiler  
20,000 board ft. per side!



Kockums  
10' x 10' Shaker Screen

**Need Something Else?**  
*Call Us... If We Don't Have It, We'll Find It!*

[www.CrownMachinery.us](http://www.CrownMachinery.us)

harvey@crownmachinery.us

Kimber Wood Shavers are distributed by Crown Machinery, LLC



**CROWN MACHINERY**

SCOTTSBORO, AL

**256-218-3045**

Fax: 256-218-3062

Sales, Service, Engineering, Installation and Removal of Equipment



**ROTOCHOPPER**  
Inc.  
Made In The USA

"Perfect In One Pass"®

**HIGH-VOLUME  
WOOD GRINDING  
SIMPLIFIED**

**The proof is in the product**  
The Rotochopper FP-66 takes high-volume wood recycling to a new level, outperforming bigger grinders while minimizing fuel costs and maintenance downtime. Best of all, the FP-66 offers the same precision grinding built into every Rotochopper, so you get better mulch, fuel, or bedding, at a lower cost per ton or cubic yard.

Follow Rotochopper on      

**320-548-3586** [www.rotochopper.com](http://www.rotochopper.com)

How can the FP-66 maximize the value of your wood waste? Contact us to learn more.

**Paul Bunyan Show**  
Oct. 2-4th  
Cambridge, OH

**THE OFFICIAL  
PAUL BUNYAN  
SHOW**

**DOUBLE the Life of your Bandsaw Blades in only 15 Minutes!!!**



**True Wheel**, a patent-pending revolutionary new hand tool machine, will change the way you crown and smooth your bandsaw wheels. The True Wheel will cut your blade usage from 3 to 4 blades per day down to only one! Potentially save \$10,000 to \$20,000 in blade usage per year!

**Manufactured & sold by True Wheel LLC Sales & Marketing.**  
For more information, contact:  
**931-469-5557 or 931-469-5558**  
[www.truewheelllc.com](http://www.truewheelllc.com)

**SIMONDS**®

**KILGORE  
SAW  
COMPANY**

**Thin Kerf  
Band Saw  
Blades**

✓ **Check Out Our . . .**  
Quality  
Service  
Dependability  
Price

See why we are your **best source for bandsaw blades!**

*Satisfaction Always Guaranteed*

 Toll Free 

**1-888-857-5153**  
E-Mail: [kilgoresaw@prodigy.net](mailto:kilgoresaw@prodigy.net)

**PRECISION-MADE SHAFTS FOR ALL MONTGOMERY HOGS & BLO-HOGS**



**ELLISON SALES, INC.**  
PORTLAND, OREGON  
**888-244-0161**  
[dan@ellisonsales.com](mailto:dan@ellisonsales.com)

**FRICKCO, INC.**  
We manufacture & sell parts for Frick sawmills.  
We also sell new Frickco sawmills.  
Call for your nearest dealer.  
**740-887-3799**  
South Bloomingville, Ohio

**STILL THE FASTEST SWING SAW FOR MOST CUT-OFF OPERATIONS**

**FAST!** **The H & A Swing Saw**

- Up to 72 Cuts Per Minute
- Greater Capacity & Easiest Operation
- 3 Models All w/Best Safety Features

"Plants" Using OSHA Inspected & Approved

**Call 1-800-397-3703**  
**H & A Swing Saw Inc. • Since 1921**  
PO Box 127 • Lockridge, IA 52635

[www.hasaws.com](http://www.hasaws.com)  
email: [hasaws10@lisco.com](mailto:hasaws10@lisco.com)



*Wood Fired* **BOILER PARTS**  
*Supplies and Materials*

**PARTS IN STOCK**

**BOILER REPLACEMENT PARTS**  
Hurst Boiler is a major supplier of boiler parts and controls that are commonly found on most boiler systems. We warehouse and stock parts and supplies for gas, oil, coal or solid fuel systems. No matter the maker, Hurst can fill all your part needs.

*The Industries Largest Supplier of Wood & Biomass Fired Boilers and Related Boiler Room Parts and Supplies*

**Pumps**  
**Controls**  
**Gaskets**  
**Valves**

**Burners**  
**Refractory**  
**Fire Bricks**  
**Water Softeners**

**CALL** Parts Sales Dept. 1 877 774-8778  
24 / 7 After Hours Parts 229 221-3338

OVERNIGHT DELIVERY

**HURST BOILER & WELDING CO., INC.**  
100 Boilermaker Lane • Coolidge, GA 31738-0530  
Tel: (229) 346-3545 • Fax: (229) 346-3874  
email: info@hurstboiler.com

**hurstboiler.com**

**High Performance Wood & Bark Hogs**

Montgomery hogs are engineered to require less horsepower and produce consistent end product with a minimum of fines

KC Punch-and-Die Hogs      T3 Punch-and-Die Hogs      Swinghammer Hogs

LRW-J Slow Speed Grinders

- ✓ Lower Input Cost for Power
- ✓ More Efficient Burn in the Boiler
- ✓ Higher Quality of Mulch
- ✓ Rugged Construction
- ✓ Straightforward Maintenance

Protect your investment with parts engineered to perform.

**MONTGOMERY**  
INDUSTRIES INTERNATIONAL

2017 Thelma Street • Jacksonville, Florida 32206  
Ph> 904.355.5671 • Fax> 904.355.0401  
www.montgomeryindustries.com

**Used & Reconditioned Equipment In Stock!**

**In Stock! Used/Reconditioned Baghouses**, such as this Torit 276RF 12—complete with rotary airlock & support steel with capacities from 5,000 CFM to 70,000 CFM depending on requirements. We stock a wide variety of replacement parts for baghouses: filter bags, cleaning head blowers & components, level detectors, rotary airlock speed reducers & drive components.

**Used/Reconditioned Fan Packages** Material handling or air handling fan, motor, drives, base & electrical (if required); 4,000 CFM to 60,000 CFM capacities available; Reconditioned units receive new paint, bearings & thorough check up!

**In Stock! A wide variety of used electrical control equipment** including disconnects, magnetic starters, solid state soft starts, used spark detection/suppression panels, spark detection/suppression detectors & spray nozzles.

**Used Woodworking Machinery**, including Fletcher banders, CNC routers, saws, wood grinders/hogs, conveyors, etc.

Check out our website at:  
[www.airsystemsmfg.com](http://www.airsystemsmfg.com)

**(828) 757-3500**  
**Fax (828) 758-5178**

**2621 Hogan Dr.**  
**P. O. Box 1736 • Lenoir, NC 28645**

**Air Systems Mfg.**  
OF LENOIR, INC.

# Kittrell Sawmill Equipment Listings

Call Jacqueline Kittrell To Locate or Sell Equipment

[www.kittrellsawmillbrokers.com](http://www.kittrellsawmillbrokers.com)

**931-698-3342**

**931-797-6284**

PO BOX 505, COLUMBIA, TN 38402



**Log Bucking System (TN)**



**Skid Steer Mount Firewood Processor (AL)**



**2012 Meadows #3 Carriage, Nice Outfit (IL)**



**4' Stacker Reduced To \$30,000 (PA)**



**GMC Truck w/Prentice Loader (PA)**



**3 HB Cleereman Mill Complete w/Deck & V. Edger**



**Tyrone 230 Carriage Drive (AL)**

### Owners Retiring

**Profitable Nice Neat Business in Northern Hardwoods Area — A Must to See!**

**Call Jackie (931) 698-3342**

✓ OUT OTHER LISTINGS ONLINE. NEED TO SELL SOME SURPLUS MACHINERY? CALL US NOW TO GET STARTED.

Email: [info@kittrellappraisals.com](mailto:info@kittrellappraisals.com)

## NOBLE MACHINERY CO.

- New Pallet Hawg Band Dismantler, In Stock
- New Waechter Power Feed Trim Saw
- Bronco 200 Nailing Machine
- Cemco 84" 6 Spdl. Vertical Borer
- Diehl 750 Straight Line Rip Saw
- Hazlethorn R-180 24" Up-Cut Saw
- Hazlethorn T-145 10" Wide Cant Sizer
- Hazlethorn Lumber Shear
- Heartland Dbl. Head Resaw w/Return
- Ind. Resources Pass One Disc Dismantler
- JBC 60" Band Dismantler
- MMT Sgl. Head Notcher, 15HP
- Mid-Oregon Trim Scrap Grinder
- Morgan Double End Trim Saw
- Morgan Board Sizer
- Piche 4-Head Multiple Trim Saw
- PRS Chain Feed Trim Saw
- Rayco Pro Pallet Nailer w/Stacker
- Saw Service 10" Trim Saw, 5 HP, 1 Ph.
- Smart Gas Powered Band Dismantler
- Smetco Tru-Cut Notcher
- Third Man Nailer
- Waechter 2-Head Horiz. Resaw
- Weinig 5-Head 4" x 9" Moulder
- West Salem 2-Stage Vertical Grinder
- Willow Creek Economy Notcher
- Rebuilt Whirlwind Up-Cut Saws
- Parts for FMC, Hazeldine & Morgan

**1-800-348-0703**

[www.noblemachine.com](http://www.noblemachine.com)

E-Mail: [noblemach@aol.com](mailto:noblemach@aol.com)



**Cornell Chop**



**LEERAY & LUKE HORTON**  
**218-372-4232**  
E-Mail: [llsales@frontiernet.net](mailto:llsales@frontiernet.net)

## Precision 58" Chipper



**Reduced to \$30,000!**

1996 Model, 6-Knife, Accepts up to a 15" Slab. New Vertical Anvil, New Feed Plate, New Wear Band, New Holder & Clamps.

Call **270-754-4087** (Robert or Anthony)

## BIOLUBE Lube Master Spray System for Cool, Resin Free Saws.

*Lube Master is the most economical, reliable, easy to operate, maintenance free lubricating system on the market. With BIOLUBE lubricants, this system will keep saw blades and woodworking tooling cool and clean.*



- Keeps all saws, bands and tooling cool and resin free
- Accurate and economical to operate
- Simple to install, operate and adjust
- Rugged for an industrial or mill environment
- All pneumatic, no electrical components
- Large 5 gallon reservoir
- Supported by a nationwide distributor network
- Everything included; brackets, nozzles, tubing, air pressure regulator, filter and gage
- Adaptable for all machinery; head saws, resaws, gang rips, package saws and moulders

### Biolube Inc.

PO Box 9732 Fort Wayne, IN 46899  
**260-414-9633 or 260-467-9208**  
Web: [www.biolube1.com](http://www.biolube1.com) Email: [sales@biolube1.com](mailto:sales@biolube1.com)



**SMALL EUROS WANTED**  
**31.5 x 47.5 - Full & Half Loads**  
**Ruma Pallet**  
**617-455-1184**  
 e-mail: [pallets@rumas.com](mailto:pallets@rumas.com)

**We Specialize in Dense Hardwood or Poplar:**

- Pallet Deckboards (1x4 & 1x6)
- Stringers (Notched & No-Notch)
- Band-Groove Components
- Custom jobs no problem

**For more information**  
 Contact: Keith Barbo  
 E-mail: [kbarbo@wvvr.com](mailto:kbarbo@wvvr.com)  
**304-472-8131 ext. 111**  
**or 304-439-0392 Cell**  
**Fax: 304-472-0212**

*WV Forest Products*  
**Website: [www.wvvr.com](http://www.wvvr.com)**  
 PO Box 9, 16 Lumber St. • Buckhannon, WV 26201

**Parts & Repairs For Your Nailing Machines...**  
 Pallet, Wooden Box, Cable Reel & Tackless Nailers  
 Specializing in FMC, Doig  
 — even older Morgan & Gage machines!

**F.W. Morse / PVI Co. • 518-747-2017**  
[www.nailingmachineparts.com](http://www.nailingmachineparts.com)  
 e-mail: [morgangageparts@gmail.com](mailto:morgangageparts@gmail.com)

**Need Parts to Fit Your Morgan Saws?**



**Sawmill Supplies & Equipment, LLC**  
**supplies parts and more!**

- Board De-Dusters
- Multi-Head Trim Saws
- Military Band Groover/Notchers
- Product & Waste Conveyors

**Tell us what you need. We'll build it... the RIGHT way!**

**Office: 318-994-2116**  
[www.sawmillsupplies.net](http://www.sawmillsupplies.net)  
 E-mail: [sawmillsupplies@centurylink.net](mailto:sawmillsupplies@centurylink.net)  
 Sarepta, LA

**Sales:**  
**Call Mona Tracy**  
**1-855-298-8890 (toll free)**  
[sales.universalmachinerysales@gmail.com](mailto:sales.universalmachinerysales@gmail.com)  
[universalmachinerysales.net](http://universalmachinerysales.net)

**Still Building the ORIGINAL Low Profile Single Resaw**

# kiln-direct.com

The leading provider of kilns for lumber, pallets and firewood



**Pallet kiln**  
280-1000 pallets



**Firewood kiln**  
6 cord MiniQuick



**Lumber kiln**  
9000-21000 bf

- Portable turn key units with fast treating time
- Heat treats and dries in the same chamber
- Computerized record keeping
- High efficiency direct gas heating
- Aluminum or stainless steel chamber
- End-load models 300-1000 pallet capacity
- Side-load models 280-700 pallet capacity
- Piggy-back system for insulated van body or container

- Wood waste or gas heat
- Easily meets 160F/75mins
- Heat treat in 8-16 hours
- Kiln dries green firewood in 1-2 days
- 6 cord (MiniQuick) up to 24 cord
- Baskets for optimized airflow are available

MiniQuick firewood kiln has been specifically designed to dry and HT firewood quickly and efficiently

- 100% aluminum construction
- Gas, hot water or steam heated
- Power venting with Heat Recovery
- Bi-fold door with electrical operation is optional upgrade
- Computerized control with wireless communication to office
- Loading capacity from 9000 bf to 21000 bf

Call us today and find out how our pallet, firewood and lumber kilns can increase your profit...

phone 910 259-1624  
 fax 910 259-1625  
[www.kiln-direct.com](http://www.kiln-direct.com)

P.O. Box 159  
 200 A Progress Drive  
 Burgaw, NC 28425

**Pallet Dip Tank**  
**Key Design Features:**

- Dip tank is fabricated in 1/8" thick stainless steel, type 304, with external painted enamel mild steel structure.
- Standard pallet carriage for pallet stack up to 114" tall and maximum 2500 lbs weight. Dead packed cut stock can also be dipped.
- Tilting carriage is fabricated in stainless steel and mild steel.
- Tilting carriage has clamp system to insure pallets or lumber is submerged.
- Hydraulic system is used for all mechanical operations.
- Estimated dip cycle for pallets is 4 minutes and is user defined.
- PLC control system with remote control for initiating the dip cycle. Dip time and other parameters are adjustable in the control cabinet display.



**Eagle Dip Tanks**  
 Complete Dip Tank Systems



[www.eaglediptanks.com](http://www.eaglediptanks.com)  
**910 259-9794**

**Attention Southeast Pallet Operations -**  
**We offer Pallet Cut Stock delivered to your plant. Reasonable prices - Reliable delivery!**

**We also supply:**

- Crating products
- Packaging products
- Treated Materials
- SYP Plywood, OSB
- SYP Lumber
- Particle Board, MDF
- Hardwood Lumber
- Import-Export wood products



**Magnolia Forest Products, Inc.**  
 P.O. Box 99 • Terry, MS 39170 • Fax: 601-878-2589

**Call 800-366-6374 or 601-878-2581**

# PRECISION CUTSTOCK!

## **GOLDEN EAGLE GANG SAW SYSTEM**

- Dust Free Lumber
- Single, Double or Twin Double Arbors
- Built-In Planer Sizer
- 8" to 25" Bay Widths
- As Thin as .125 Kerf in Double Arbors
- Variable Feed Rates

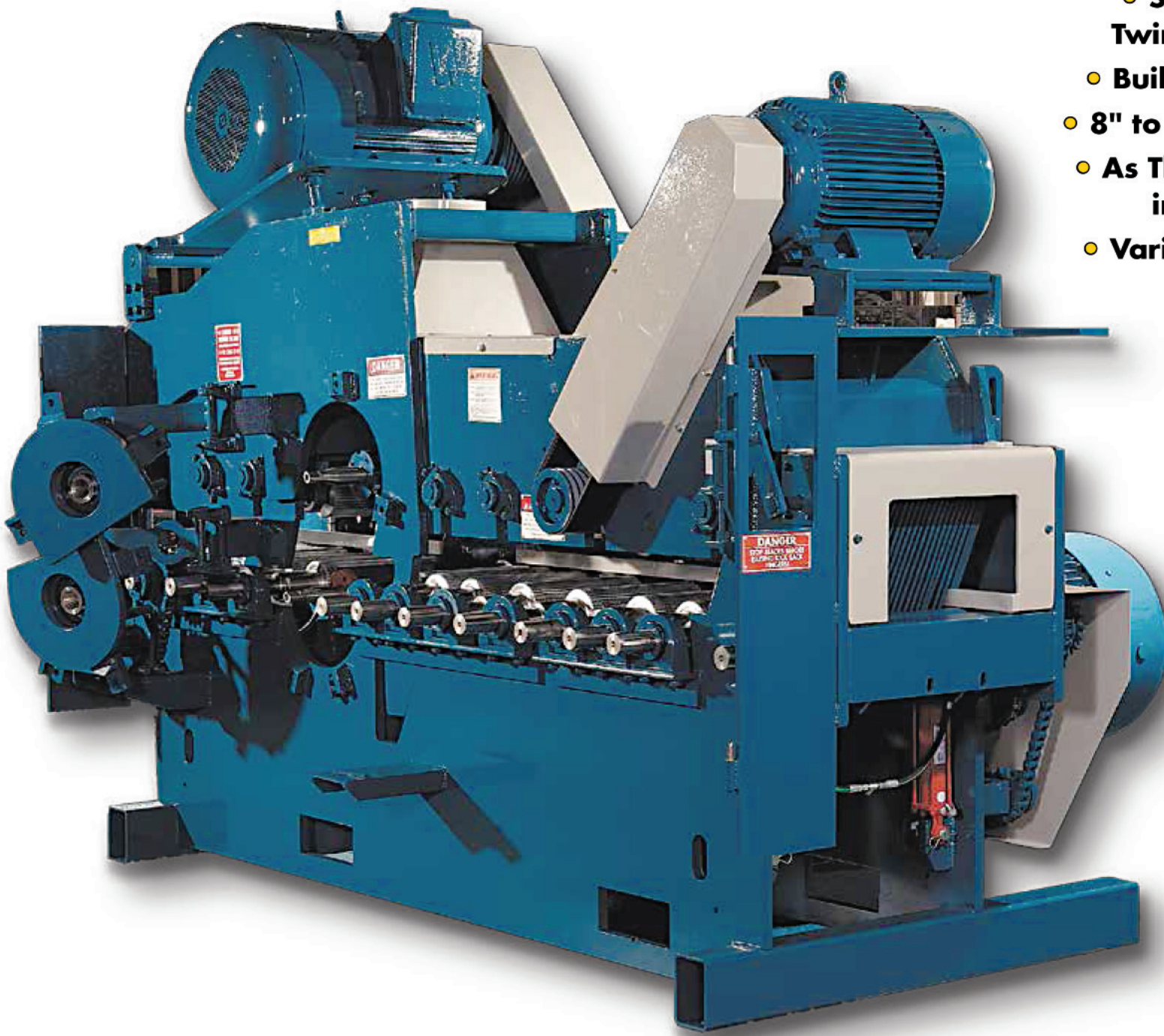

**800-345-6516**  
[www.brewermach.com](http://www.brewermach.com)

FULL PRODUCT LINES FOR PALLET, STAVE, GRADE AND RAIL TIE INDUSTRIES.

# The Best Insurance Money Can Buy For Your Band Saws

## The Proctor Roll from Hanchett...

The Roll attaches easily to **ANY** band saw grinder and works automatically as the saw is fed through the roll.

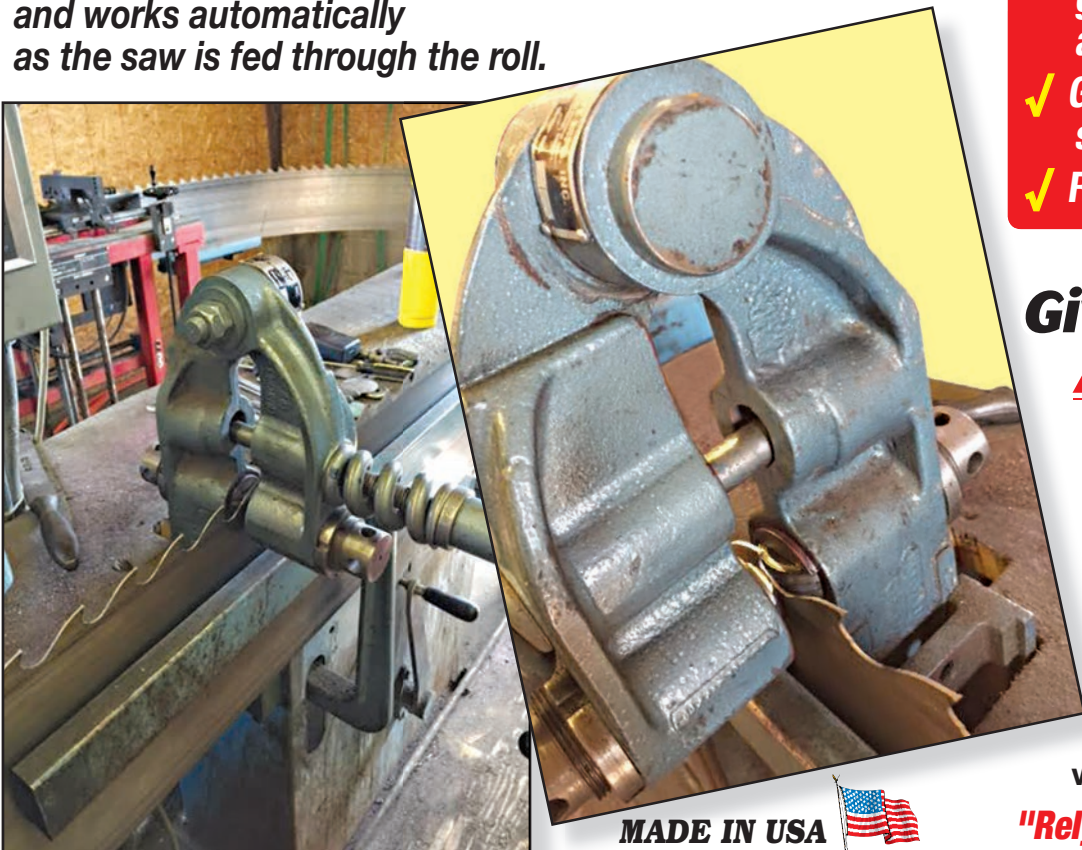

MADE IN USA 

- ✓ Prevents cracks
- ✓ Provides superior tensioning which leads to greater feed, straighter cuts, longer saw life and smoother lumber
- ✓ Gives the gullet a beveled edge so cracks can't start
- ✓ Reduces saw costs

Give Your Band Saws **A Fighting Chance!**



**HANCHETT**  
**MANUFACTURING, INC.**  
**800-454-7463**  
**231-796-7678**

www.hanchett.com • E-mail: ralphm@hanchett.com

**"Rely on Hanchett — Saw Filers Have For Over 100 Years!"**

**CEMARLINE®**  
 www.cemarelectro.com



**CEMAR ELECTRO INC.**  
**LASERS**

**GREEN!**  
 5,15,30,50mW

**5-30 mW RED LASER**

- Industrial Strength
- Patented Linear Optics
- 48-Hour Repair Service
- Powershift™ Technology
- 2-year Warranty

Call Toll Free Today:  
**1-800-298-5273**  
 Fax: 518-298-2927

**Every Reputable Wide Band Supplier Offers...**

- ✓ High Quality Swedish Steel
- ✓ 3" - 8" Band Width
- ✓ 16 to 20 Gage
- ✓ Double Cut Options
- ✓ Choice of Swage or Stellite

**BUT ONLY THE WOLVERINE BY MENOMINEE SAW GUARANTEES...**

- Cutting Edge Plasma Welds
- The Industry's Highest Cutting Capacity Band Saw
- Quick Delivery from our HUGE Inventory
- Fast Sharpening & Exchange Program to Keep YOU Running
- Competitive Pricing

And **ONLY** Menominee Gives You Everything You Need in a Wide Band Saw - Plus Expert Service from the Industry's Most Knowledgeable Staff.

**Got a Wide Band Problem?**  
 Call Menominee Saw Today and You'll Learn Why More Mills Trust the Pros!



**TOLL FREE**  
**1-800-582-0470**

**WWW.MENOMINEESAW.COM**  
 Email: info@menomineesaw.com

# HUGE INVENTORY

**Special Limited Time Pricing**  
*Hurry — Don't Miss these incredible bargains.*

**Miscellaneous Equipment**

17647	MDI Metal Detector Coil for Logs 40 x 32	\$500
34569	CORLEY Bar Type Log Turner	\$500
55655	MELLOTT #5 Chain Log Turner	\$3,000
55577	CORLEY Bar Log Turner	\$500
39780	Pallet Plater	\$500
40129	ALLEN BRADLEY 250 HP Starter	\$800
55389	TIMESAVER Belt Sander for parts	\$1,500
55455	Pallet Brander	\$500
55706	10 HP Hydraulic Pump w/tank	\$750
55952	Custom Disk Scalping Screen	\$2,000
56013	DINGS Electro Magnet	\$1,000
56110	MELLOTT Rosserhead Debarker	\$15,000
56130	HMC Rosserhead Debarker	\$6,000
56187	200' Carrier Vibrating Conveyer	\$15,000
56356	BLUE M Electric Industrial Oven	\$750
56378	MORBARK Post Peeler	\$7,500

**Filing Room Equipment**

56367	I.M.W. Auto Dual Side Grinder	\$2,500
56292	TRISTATE Cutterhead Grinder	\$2,000
56171	WESTERN MACHINERY Cutterhead Grinder	\$5,000
56085	ISELI Bandsaw Leveler	\$9,500
55604	WEINIG Profile Grinder	\$3,000
55605	HANCHETT #400 Bandsaw Grinder	\$2,500
55584	NEWMAN Knife Grinder G-132	\$1,500
55442	ARMSTRONG #2 Bandsaw Sharpener	\$1,500
55443	ARMSTRONG #2 Bandsaw Sharpener	\$1,500
55365	PRECISION Knife Sharpener	\$1,500
55238	HANCHETT 413 LH Bandsaw Sharpener	\$1,500
54984	GROB Bandsaw Butt Welder	\$250
54619	PRECISION Tub Type Knife Grinder	\$3,500
34742	ARMSTRONG Tru-Sizer Dual Side Grinder	\$2,000
34749	CASCADE SOUTHERN Dual Side Grinder	\$1,500
28066	ARMSTRONG #6 Bandsaw Grinder	\$1,500
28584	CAPITAL 96" Bar Type Knife Grinder	\$1,500

12086	ARMSTRONG Model 25 Circle Saw Sharpener	\$500
11838	HANCHETT A230 RH Bandsaw Grinder	\$500
32658	UNITED TOOL Profile Grinder	\$500
55959	ARMSTRONG Side Pro Bandsaw Sharpener	\$3,500

**Dust & Shavings Handling Equipment**

12476	53" Blower	\$300
12104	AMERICAN Air Filter Baghouse	\$300
56290	50 HP Material Blowing Fan	\$1,800
55076	Rotary Airlock/Feeder	\$1,500
55628	PHELPS 75 HP Blower	\$2,500
55890	60 HP Blower	\$1,000
56272	Twin PEERLESS 30 Unit Bins	\$25,000

**Carriage Drives**

55551	TYRONE BERRY #214	\$1,500
55576	GATOR 40 HP Hydrostatic	\$2,000
55583	TYRONE BERRY 25 HP	\$1,000
56055	TYRONE BERRY 260	\$7,500
56264	TYRONE BERRY 270	\$20,000

**Air Compressors**

56393	GARDNER DENVER 100 HP Screw	\$3,000
55422	100 HP LEROI Screw	\$2,000
35232	INGERSOL RAND Portable	\$1,500
56227	IR 25 HP Screw Type	\$2,000

**Saws**

12524	GRUTTER Chop Saw 5 HP	\$100
27709	CORLEY 648 Edger	\$1,000
30893	WINDHAM Small Log Slasher	\$500
37311	MCDONOUGH Center Split Resaw 54	\$6,000
40126	KLAMATH 7' Right Hand Headrig	\$5,000
54656	DIEHL Straight Line Ripsaw	\$5,000
56221	PRECISION Popup Saw	\$850
55025	WEST PLAINS Cant Sizer	\$4,000

Visit our website [www.benjones.com](http://www.benjones.com) and refer to the item numbers as listed for additional information.





BEST BLADES!  
**PIPER'S SAW SHOP**  
 BEST DEALS!  
 ALL IN ONE PLACE!



Ask about the  
*Piper Chopper*  
 for your Scrap Blades!!!

**800-845-6075**

**Selling at Auction**  
 Cadiz, KY - October 15<sup>th</sup>



Rebuilt Cleereman Carriage  
 See ad in this issue or call  
**1-800-334-4395** or visit  
[www.tristate-auction.com](http://www.tristate-auction.com) for more info.

---

**Viking® Machine Parts For Sale**  
 Call Jerry Lottes Parts Sales  
 (PH) 704-283-1920  
 (CELL) 704-221-2205  
 (FAX) 704-283-8716

# REDUCTION Sale!

**Right Now thru October 15th!!**

Some items are priced 50% OR MORE below our usual prices...

55579	CARTHAGE 4-Saw Edger	\$1,500
54564	KOCKUMS/CORLEY Linebar Resaw	\$10,000
55602	2-Saw Trimmer	\$2,000
55728	NEWMAN K20 4-Saw Trimmer	\$7,500
55787	PENDU M4000 Gangsaw	\$12,000
55851	MEREEN JOHNSON Gang Ripsaw	\$7,500
55591	Center Split Circular Resaw	\$2,000
56056	SALEM 6' Band Headrig	\$8,000
56287	SMITH 2-Head Horizontal Resaw	\$6,000
56288	LM Verticut Package Saw	\$5,000
56377	MORGAN Log Cutoff Saw	\$7,500
56379	MORGAN End Trimmer	\$3,500

**Chippers**

55644	54" FULGHUM Chipper	\$6,000
55917	BUSH 48" Re-Chipper	\$4,000
55733	BUSH 48" Re-Chipper	\$5,000
55978	FULGHUM 48" Chipper	\$8,000
55990	FULGHUM 48" Chipper	\$6,000
56010	FULGHUM Chipper	\$15,000

**Hogs**

34240	MONTGOMERY Wood Hog 34 HD	\$2,500
55539	JACOBSON Horizontal Hog	\$5,000

55805	PROGRESS Hog with 150 HP Motor	\$8,000
56258	JEFFREY 55 WB Wood & Bark Hog	\$25,000
56166	ARASMITH Bark Grinder	\$15,000

**Planers & Moulders**

36653	YATES B24 Double Planer	\$4,500
40086	YATES B26 Double Planer	\$16,000
54432	MATTISON 12" Moulder	\$6,000
55545	NEWMAN WHITNEY Double Planer	\$2,000
55600	YATES American A20 Planer	\$12,000
55601	NEWMAN Planer Feed Table	\$2,000

**Lumber Handling Equipment**

28941	MOTION INDUSTRIES Scissor Lift	\$500
55381	PENDU Tilt Hoist	\$9,500
55725	PAUL Unscrambler	\$6,000
56144	BUSS AUTOMATION 8' Tilt Hoist	\$15,000
56168	8' IRVINGTON MOORE Tilt Hoist	\$7,000

**Forklifts & Loaders**

56089	HYSTER 15,000 LB Forklift	\$3,500
56128	HOOD Self Propelled KB	\$8,000
56129	TAYLOR 25,000 LB Capacity Forklift	\$6,500
56247	BARKO 160 Stationary KB	\$16,000



**Ben Jones Machinery**

Div. of Dickert Enterprises, Inc.

Industry's Most Trusted Source

203 17TH STREET • COLUMBUS, GA 19978

Contact Eric Doss

Toll Free US and Canada

800-241-8983

706-324-2604

Email: eric.doss@benjones.com

Contact Jim Lichucki

770-704-7918 (Office)

706-570-2697 (Mobile)

Email: jim@benjones.com

Visit our website [www.benjones.com](http://www.benjones.com) and refer to the item numbers as listed for additional information.

Wood-Mizer  
**CONFIGURATOR**

**Build & Price  
your Sawmill at  
[mywoodmizer.com](http://mywoodmizer.com)**

# HOGZILLA

**MONSTER TUB &  
HORIZONTAL  
GRINDERS,  
Electric or  
Diesel Power**

TC-1664SE Stationary  
Electric Powered  
HogZilla Shown.  
Give us a call about  
converting your diesel  
powered machine  
to Electric Power.

**CW Mill**

Equipment Co., Inc.,  
Sabetha, Kansas U.S.A.

Toll Free: 800.743.3491

P 785 284 3454 F 785 284 3601

Email: hogzilla@cwmill.com

[www.HOGZILLA.com](http://www.HOGZILLA.com)



## Operator Cabs!

Invest in Superior Quality and Workmanship.



Large or Small,  
We Build Them All

**LAKE SUPERIOR CABS, INC.**

Esko, MN

Specialized Orders - No Problem • No Minimum Quantities

Call Dean Myers • 800-328-1823

[www.lakesuperiorcabs.com](http://www.lakesuperiorcabs.com)

## Over 12,000 Edgers Built And Still Going Strong

Meadows Mills' acquisition of Miner Edger means we have more edger building experience and more edgers in operation worldwide than anyone else. So trust your next edger investment to the real experts. We've been building better sawmill equipment since 1902!

6", 7" or 8"  
Combination  
Edgers

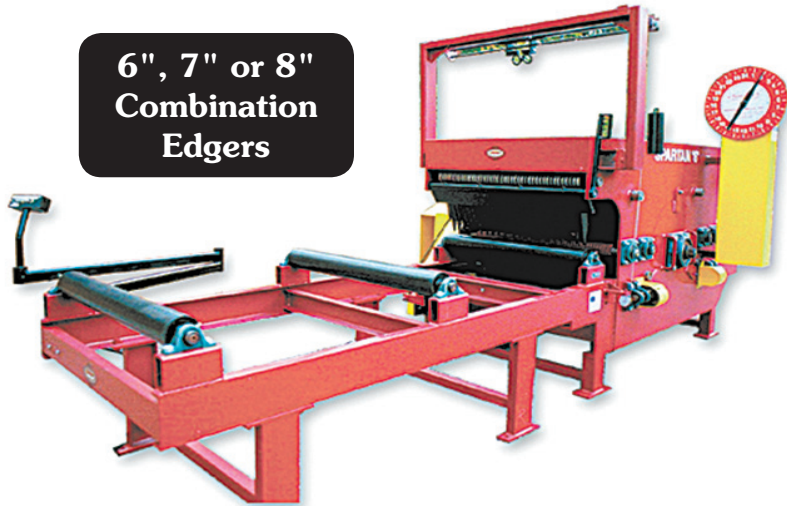

- Available with 6", 7", and 8 1/2" depth of cut
- Frame widths available in 36", 42", or 48"
- Solid steel side plates with door for easy saw changes
- Made in USA
- Call Meadows Mills and let us design a combination edger to improve your efficiency and profit!

**MEADOWS MILLS, INC.**  
**800-626-2282**

www.meadowsmills.com • e-mail: sales@meadowsmills.com



### WIN THE BATTLE BETWEEN QUALITY AND PRICE.

A-8 Modified Chipper Steel Knives

Inserts/Tips

AR450 Grates

Don't sacrifice performance for price! Use Winn Wear Parts and Supplies' top-quality wear parts in your chippers and grinders. With high-quality materials like the A-8 modified chipper steel in our knives to the tungsten impregnated overlay on our inserts, our wear parts are built better to last longer...for less!

**WINN**  
WEAR PARTS & SUPPLIES

**Call for a quote today at 844-262-3649!**  
**Or visit us at [www.WinnParts.com](http://www.WinnParts.com)**

# QUALITY USED EQUIPMENT



LIKE NEW!

**Baker C Model  
4 Head Band Resaw**



with Turnarounds

**Baker D Model  
Band Resaw System**



with Turnarounds

**Baker BX Model  
Resaw System**

SALE!



**Baker 7 Head  
C Model Resaw**



**Baker M412  
Planer/Moulder**



Twin Saw

**Morgan  
Scragg Mill**

SALE!



**West Plains  
Chamfer Machine**

SALE!



**Miner  
Stationary Edger**

SALE!



**FOR MORE INFORMATION AND PRICING**

click 'used equipment' at [www.bakerproducts.net](http://www.bakerproducts.net) or call 573.663.7711

# Fast, Durable, Productive Machinery For Pallet & Lumber Mills - Recycled & New Producers!

## 26 years Building Dependable Machines Heartland Fab. & Machine



**B54E**  
Band Saw  
Pallet Dismantler



**STS10**  
Single  
End  
Trim Saw

Band saw pallet dismantlers, single end trim saws, multi-head trim saws, chop saws, disc-type pallet dismantlers, conveyors & conveyor systems, rotary tables and custom machinery.



**Heartland Fabrication & Machine Inc.**

Pulaski, WI Phone: 920-822-2215, Phone/Fax: 800-422-2215

www.heartlandfabandmachine.com • e-mail: heartlandfabandmachine@gmail.com

**1-920-822-2215**

## The Longest Lasting Debarker Head on the Market!

Why? Cutting Edge technology allows the carbide teeth to be indexed up to 6 times before they need replacing. That saves you money!

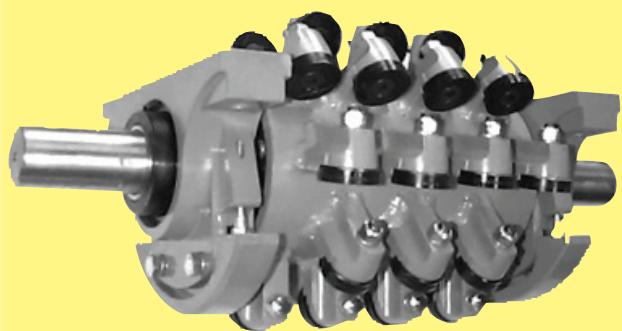

- 12" & 15" models
- Solidly constructed with All Steel bodies

The Bark-King Depth Control bearing can be used on many Rosserhead debarking heads to provide excellent control of the debarking process by preserving wood fiber.

**Again — this saves you money!**



So, get the #1 performing head on the market AND save money!  
**Find out more by calling**

**Stringer Industries, Inc.**

**1-601-876-3376**

Or visit [www.bark-king-tools.com](http://www.bark-king-tools.com)



## Hardwood Pre-Cut Pallet Material

- #1 and #2 Material (Available in deck boards and runners.)
- Various Sizes & Lengths

### Other Products Available

Sawdust • Mulch • Raw Bark • Boiler Fuel  
Chips • Chunk Wood • & MORE

Call **740-226-2090** | [www.millwoodinc.com](http://www.millwoodinc.com)

# Trash to Cash!

## SLAB WOOD CHIPPER

- Two Models to Choose From
- 40HP Gas, Subaru Engine
- 63HP Diesel, Mitsubishi Engine
- Belt Drive to Cutter Head
- Variable Speed Hydraulic Drive to Feed Wheels
- Auto Feed Counts Cutter Head RPM
- Material Exit Conveyor
- 4" x 24" Infeed Opening



WC-8 37A, 37B, 37C, 37D 2015  
**Sunbelt Ag Expo**  
 North America's Premier Farm Show  
 Oct. 20-22 • Moultrie, GA

Lot #433  
 THE OFFICIAL  
 PAUL RUNYAN  
 SHOW  
 Oct. 2-4  
 Cambridge, OH



Davis Sawmill, Plattsburgh, NY

"My customers are very happy with the product that I'm providing them with. The Salsco Slab Chipper stays well ahead of my circular saw mill. I've been able to double my sawdust production."

## SHAVING MILLS - CONVEYORS SHAVINGS RE-SIZER - SHAVINGS DRYERS

Shaving Mills Are Available Both Portable or Stationary  
 With a Blower or Conveyor Drop, PTO Driven - Diesel Engine Driven - Electric Driven



- 12" - 9 cubic yards
- 20" - 16 cubic yards
- 30" - 25 cubic yards
- 40" - 33 cubic yards
- 60" - 50 cubic yards

Salsco will provide you with a machine and system to fit your production & operational needs at a much lower price than any other Shaving Mill on the market! After looking at all the Shaving Mills on the market, No unit beats Salsco in terms of production or cost!

105 School House Road  
 Cheshire, CT 06410  
 203-271-1682  
 203-271-2596 (Fax)

[www.salsco.com](http://www.salsco.com)  
**800-872-5726**  
 MADE IN THE U.S.A.

**Salsco, INC.**  
 LEADER BY DESIGN

## Attention Northeastern Pallet Manufacturers:

We're Your Logical Choice for Precut Material — for over 20 years!

- HARDWOOD & ASPEN
- CHAMFERING AND NOTCHING AVAILABLE
- VERSATILE PRODUCTION FROM BOTH SCRAGG MILLS AND REMANS

TEL: 418-872-7171 FAX: 418-872-6622 e-mail: [sales@precutwood.com](mailto:sales@precutwood.com)

See our website [www.precutwood.com](http://www.precutwood.com) for board & stringer sizes and species.



INTERNATIONAL C.L. INC

## Heat Treat Stamps



Branding Irons  
 and Hot Stamps  
 Propane or Electric  
 ISPM 15 Compliant  
 also Available For Nailers



BrandNew Industries, Inc.  
 (800) 964-8251  
[BrandNew.net](http://BrandNew.net)

## HUGE 2-Day LPS Annual Inventory Reduction Sale!

Hundreds of items will be offered at auction! Don't Miss It!



Scragg Mills — Overhead, Sharp Chain, All Sizes!



Toll Free:  
**800-598-3651**  
[associateauctioncompany.com](http://associateauctioncompany.com)

## USED EQUIPMENT

We own what we advertise!  
**New Equipment Arriving Weekly**



**866-546-8864**

<http://pallet-repair.com/viewused.asp>



**NEW PRECISION 58" Chipper**

Ben Jones Machinery

Div. of Dickert Enterprises, Inc.

Industry's Most Trusted Source

**800-241-8983**

See more equipment at [www.benjones.com](http://www.benjones.com)



# STREAMLINE LASERS



**OUR MOST POPULAR ELD-15**

**IS THE INDUSTRY STANDARD FOR LONG LIFE & DURABILITY**

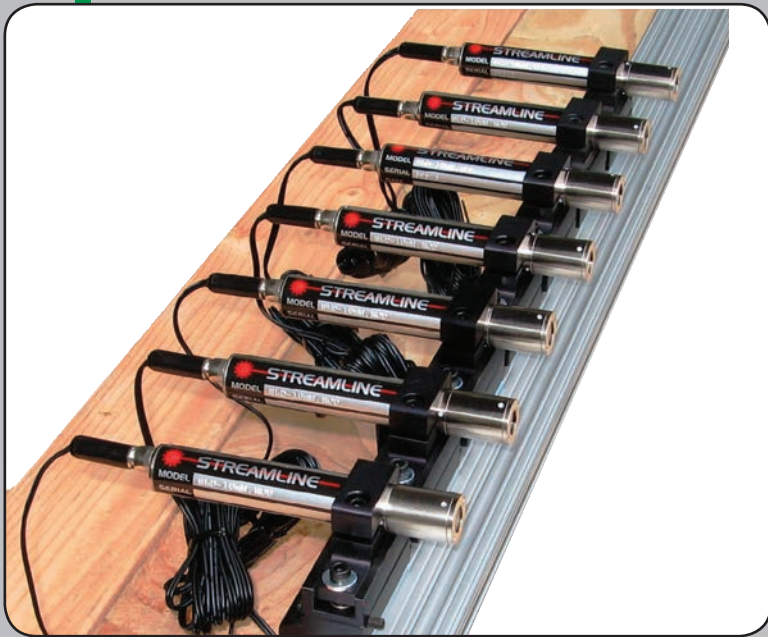

## Get It All

- Cost Less Up Front!
- Longer Useful Life (*means it costs EVEN LESS!*)
- Superior Components
- Standard & Premium Grades Offered
- Straight Talk – we ONLY sell you the laser YOU NEED!
- Two Year Warranty on Most Lasers Sold
- Thinking **GREEN** Lasers? Call to Get the FACTS FIRST!

**The EGL Has Landed... Again!**  
**The New EGL Series of**  
**Green Diode Lasers**

- \* *Economical*
- \* *Precise*
- \* *Enhanced Visibility*



**Before you Buy ANY LASER –**  
**For ANY Forest Industry Application**  
**Call Ellison Sales FIRST!**



Shift Kits Available for Moveable Saw Applications

**The Laser Choice Since 1972 – Over 40 Years Of Laser Manufacturing and Straight Talk**



**ELLISON SALES**  
**Toll-Free: 888-244-0161**  
**E-mail: dan@ellisonsales.com**  
**www.ellisonsales.com**

# Cut Your Blade Costs – Keep Your Profits!



**The Pallet Hawg Bandsaw Dismantler will pay for itself in no time in blade savings alone!**

- One or Two Man Operation or Pallet Prep Saw
- The most versatile Pallet Dismantler Available
- Gear Reduction Drive for Long Blade Life
- Pneumatic Table Travels 5 1/4" to Allow for Easy Stringer, Block, or Deckboard Removal

## NEW Power Feed Trim Saw

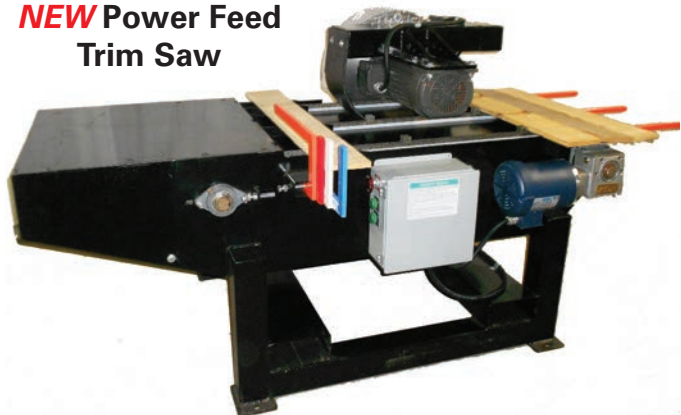

- Up to 12,000 trimmed boards per 8-hour shift!
- 4 adjustable board stops, set from 16" to 66" long
- No belts or pulleys to wear out or replace
- Handles stringer & deck boards up to 2 1/2" thick

## NEW Pallet Hawg Up-cut Saw



- Trims both new & recycled lumber
- 10 HP, 18" blade
- 5" x 6" capacity

*Change is good.*

**Get more blade life AND a smoother, more efficient operation.**

Call Brad or Kent @  
**1-800-348-0703**

[www.noblemachine.com](http://www.noblemachine.com)

**NOBLE MACHINERY CO. INC.**



## HUGE 2-Day LPS Annual Inventory Reduction Sale!

Hundreds of items will be offered at auction! Don't Miss It!



**Numerous Carriages & Modular Mills**

*Lots of sizes and prices to choose from!*

**ASSOCIATED AUCTION**  
& Liquidation Co.

**Toll Free:**

**800-598-3651**

[associateauctioncompany.com](http://associateauctioncompany.com)

## Need Parts to Fit Your Morgan Saws?



**Sawmill Supplies & Equipment, LLC**  
supplies, parts and more!

Office: **318-994-2116**

[www.sawmillsupplies.net](http://www.sawmillsupplies.net)

E-mail: [sawmillsupplies@centurylink.net](mailto:sawmillsupplies@centurylink.net)

Still Building the ORIGINAL Low Profile Single Resaw



**WE REBUILD MONTGOMERY HOG ROTOR ASSEMBLIES**

**ELLISON SALES, INC.**  
Toll-Free: 888-244-0161  
[dan@ellisonsales.com](mailto:dan@ellisonsales.com)

**CEMARLIGNE**

## NEED A LASER?

**SEE PAGE 35...**

**CEMAR ELECTRO INC.**  
THE LEADER IN LINE LASER TECHNOLOGY

**Your Cut Stock Source**  
[www.SomersLumber.com](http://www.SomersLumber.com)  
(704) 539-4751

Now offering  
Common Carrier Services

- SYP Cut Stock
- Panel Cut Stock/CNC
- Band Groove

Union Grove, NC

Try our tool risk free for 30 days!

## NEW Tech® PCN-55M

**TECH**

### The better alternative for pallet recyclers

### More power, less weight & better durability.

For driving nails 1-3/4" to 2" with diameters .083" to .090", we proudly introduce the new Tech PCN-55M nailer.

After many years of experience working with pallet recyclers, we've designed our new tool with features like a thicker reinforced nose and contact arm for extra durability, and air flow that is optimized to generate more power with less weight - a third to a half a pound lighter than competitive tools.

Our customers also report that the new PCN-55M holds up better in colder winter temperatures.

Although nail pricing is one component when choosing a company, an even greater consideration for us is the nail guns. Being a recycler, wood density varies from softwood to rock hardwood. The Tech 55M handled all materials with ease. It has increased production by approximately 30%. A single individual was able to increase his output from 200 to 300 pallets per day, very impressive. Overall its proven itself as a money maker for the company.

- Steven Streater: Enpac Pallets & Crates Inc.

**METROPOLITAN**  
STAPLE CORP.  
[www.metrostaple.com](http://www.metrostaple.com)  
[info@metrostaple.com](mailto:info@metrostaple.com)  
800-255-7209



**West Plains  
400 Series  
2 Head Resaw**

Call today for more information

**PALLET MACHINERY GROUP**

**540-644-9220**

or visit [www.palletmachinery.com](http://www.palletmachinery.com)

E-mail: [info@palletmachinery.com](mailto:info@palletmachinery.com)

**STRAIGHT TALK & SAWMILLS**  
*That's What You Get at Sawmill Exchange!*

**OVER 800 LISTINGS!**

Band or Circular Sawmills, Portable or Stationary, Manual or Auto, Hobbyist to Professional Models.

**Plus, the Support Equipment to "Make Your Dream Mill a Reality."**

Like Resaws, Edgers, Planers, Dry Kilns, Chippers, Loaders, Firewood Processors and More!

**\$85,000**



- LT 300 WOODMIZER with Off Load Conveyors
- WOODMIZER Twin Blade Edger
- CMC 20 ft. Double End Trim Saw with Setworks
- Mellott Rosser Head "De-Barker" with In and Out Log Decks
- Baker Single Head Re-Saw
- Newman 500 Planer All Electric (3 Phase) with Multiple Heads
- Morbark 48 inch 3-Knife Chipak
- All Connecting Conveyors and Sawdust Removal Blowers

Location: Washington • Ad#: 16836

Call Today to Sell Your Mill  
or Receive Current Inventory Listings!  
Or Go Online —

[www.sawmillexchange.com](http://www.sawmillexchange.com)

**SAWMILL EXCHANGE**

**800-459-2148**

713-729-6455 (713-SAWMILL) • Fax 205-453-4262

**2 CHOICES for MORE FIREWOOD PRODUCTION!**

**NEW Model 18-20 Hornet Firewood Processor**



18" Diameter, 24" Stroke

- Sell Bundled Firewood to Convenience Stores, Campgrounds, and State Parks
- Seven Bundle Sizes Available:
- Electric or Gas
- Wrap a Cord of Bundles Per Hour
- Wrapper Priced Under \$1,700



See our complete catalog at

[www.twister-industries.com](http://www.twister-industries.com)  
[chuck@twister-industries.com](mailto:chuck@twister-industries.com)

**Twister Industries**

Phone: **(320) 679-9835**

Cell: (612) 390-9620

2266 Hwy. 65 • Mora, MN 55051

Hornet Processors, Bundle Wrappers, Re-splitters, Skid Steer splitters, Wood Splitters, Conveyors

**Twister Hornet Model 2530 Firewood Processor**



2-4 Strand Live Deck, Tandem Axles, 45 Gal. Fuel & Oil Cap.

**BANDSAW BLADES**

We have the most popular sizes in stock & ready to ship from major manufacturers, including...

**LENOX** **Wood-Mizer Blades**  
Your Leader in Blade Technology.

**Welded to your lengths!**

We also offer expert Sharpening Services, plus...

Gang • Edger • Scragg  
Trim • Split • Strob

...and just about any Custom Saws you need to keep you cutting longer...for less!

Call Marvin Miller for a quote

**231-924-5953 (fax) 231-924-6166**

In Stock —  
**READY**  
To Ship

Ask About  
**FREE**  
Shipping!

**MIDWEST**  
SHARPENING SERVICE

**PAWTAWJOHN**  
**SERVICES, INC**  
(208) 687-1478 / [www.pawtaw.com](http://www.pawtaw.com)

**MTS** Factory Authorized MTS  
Temposonics® Distributor  
and Warranty Repair Center  
Cleereman carriage systems provider

**FIRST-CLASS  
EQUIPMENT &  
DEPENDABILITY**

**AND EXCELLENT SERVICE  
AVAILABLE 24/7**

Do you have internet access in your mill?  
Ask us about our machine monitoring capabilities.

**Check out our  
Reliable Resaw Networks**

For Your Horizontal or Vertical Saw.  
Easy. Efficient. Affordable.



# SMART PRODUCTS

*Is Your Answer! For Pallet Lumber Recovery and Repair Solutions.*

*"The Difference is Engineering"*

**Leasing & Financing Alternatives Available**

## Dismantlers

### One-Man Dismantler



- 52" or 64" capacity
- 10 HP, 3-phase, electric motor standard (2200 FPM blade speed) (single phase available)
- Optional 15 HP, 3-phase (4400 FPM blade speed) electric motor available
- 18 HP gas-powered electric start on Portable Dismantler
- Gear reduction drive
- Self-contained hydraulic blade tensioning
- Low maintenance durable blade guide bearings
- Push button operated table height adjustment

### Two-Man Dismantler



### Pallet Dismantler System

- 64" capacity **Front Discharge** Dismantler
- Linear accumulating conveyor feeds boards easily to operator of Inclined Power Trim Saw
- Add additional dismantlers for higher production

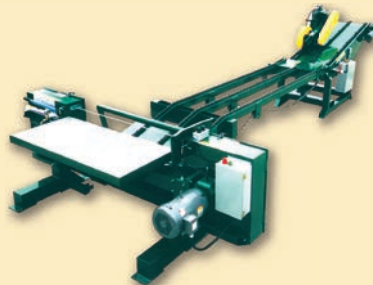

### Portable Dismantler



## Notchers

### Double Head Notcher

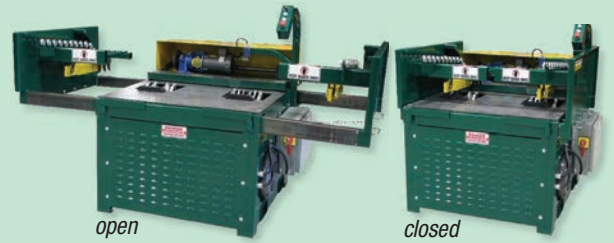

- Two, 20 HP, three (3) phase, electric motors with V-belt driven indexable notching cutterheads
- One-person operation/1,000 double notched stringers per hour
- Notches new or recycled lumber
- 48" to 96" stringer capacity standard
- 9" x 1-1/2" notches, with 18" between notches
- Quick set-up
- Continuous power feed system
- Self exhaust design (useful when notching recycled material)

### Single Head Notcher

- 20 HP, three (3) phase, electric motors with V-belt driven indexable notching cutterhead
- One-man operation/500 double notched stringers per hour
- Notches new or recycled lumber
- 72" stringer capacity standard
- Quick set-up
- Continuous power feed system
- Self exhaust design (useful when notching recycled material)



## Pallet Prep



- Commonly referred to as the "SmartSaw"
- Smart Saw is **multifunctional**: designed for repair (1 person) or recycling (2 person) operations of BLOCK or GMA/STRINGER pallets
- Standard 10 HP, 3-phase, electric motor with gear reduction drive
- 20' standard **M42 bi-metal** band saw blade
- Air actuated, 3-position, roller table and table extension easily positions pallet for board removal
- Machine provided with **advanced safety measures** in place, including interlock switches for perimeter guarding and cabinet doors
- Improved **canopy guarding**, with front and rear portions that move up and down with the roller table

- Specifically designed to QUICKLY (as a **1-person** operation) cut out damaged boards, including **top and bottom** deck boards, as well as **connector** and **stringer** boards
- Also designed, as a **2-person** operation, to process the disassembly / tear-down of block or stringer pallets for **INCREASED LUMBER RECOVERY**. For block style machine, includes a specially designed **Block Recovery Tool** (or BRT) that **salvages blocks** now being scrapped with other machines and processes

### Double End Power Feed Trim Saw



## Trim Saws

- Power Feed Trim Saws trim boards 2" thick from 18" - 60" in length on the single end, and 18" - 66" in length on the double end
- Inclined board feed and overhead saw design help eliminate board kickback
- Manual Trim Saw handles boards up to 6" thick and 6" wide
- 18" diameter nail resistant saw blades and 10 HP motors
- Heavy duty steel tube construction
- Multiple adjustable board stops on Single End and on Manual Feed Trim Saws
- Easy blade change
- Easily moved with built-in fork lift pockets
- Right saw head on double end easily adjusts to cut desired board length

### Single End Power Feed Trim Saw



### Manual Feed Trim Saw

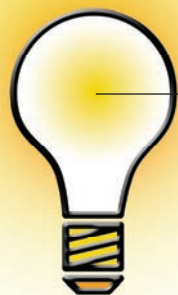

## SMART PRODUCTS

3401 North Commerce Drive • Muncie, IN 47303  
 Ph: 765.284.9545 • Fax: 765.284.7270  
 website: [www.smartproductsinc.com](http://www.smartproductsinc.com)  
 email: [smartpro@smartproductsinc.com](mailto:smartpro@smartproductsinc.com)

# 800.401.0099

Every machine we build is backed by the pallet industry's most trusted and respected reputation. You can count on us being here long after the others are gone.

# MULTI-HEAD END TRIMSAWS BUILT BY THE MORGAN FAMILY

**PROCESSES BOARDS OR CANTS WITH PRECISION ACCURACY AT TOP PRODUCTION!**



- AVAILABLE IN 2, 3, 4, & 5 HEAD MODELS
- EACH ONE EQUIPPED WITH 20" CARBIDE BLADES AND A 10 HP MOTOR PER HEAD
- ADJUSTABLE HEADS WITH VARIABLE FEED SPEED
- SPRING LOADED ADJUSTABLE HOLD DOWNS
- 5 HP HYDRAULIC UNIT POWERS CHAINS

» **OPTIONAL EQUIPMENT INCLUDES** «  
 LARGER BLADES (22") AND MOTOR (20 HP)  
 PLUS PRODUCT AND WASTE CONVEYORS



**A family owned business. Builders of the ORIGINAL Low Profile Band Resaw.**  
**Need parts for your Morgan Saw? We've got 'em!**

**Sawmill Supplies & Equipment LLC**  
 Sarepta, LA  
**318-994-2116**  
 e-mail: sawmillsupplies@centurylink.net  
[www.sawmillsupplies.net](http://www.sawmillsupplies.net)

**Sales Office:**  
 Mona Tracy  
**Universal Machinery Sales, Inc.**  
**1-855-298-8890**  
 e-mail: info@universalmachinerysales.net  
[www.universalmachinerysales.net](http://www.universalmachinerysales.net)



**LITCO International, Inc.**  
**Export and Domestic Pallets**  
**Load Securement Solutions**  
**Molded Core Plugs**

**Carry on.**

All Litco products are designed to **Carry** your products safely **on** through the most demanding supply chains.

**LITCO IS SEEKING PACKAGING SALES PROFESSIONALS**

Do you want to be part of a growing company and sell an exclusive product? If so, Litco is seeking a self-starter to sell our Inca molded wood pallets, core plugs and related transport packaging products.

**We have openings in the following regions**

- In or near Louisville, KY, Southern IN, IL, MO
- Eastern PA or the Northeastern portion of the USA
- Southeast, in or near AL, MS, GA or TN

**Our ideal candidate for the position**

- Is willing to travel multiple states
- Is experienced at selling direct and through distributors
- Has 5+ years of experience and a list of established contacts that palletize for both export and domestic shipping
- Has a proven record of sales success and a list of established contacts in our target markets

**Litco offers**

A comprehensive benefit package and a competitive compensation program with the opportunity for advancement

If you are our ideal candidate, we want to hear from you Today!

Visit our careers page to apply on line at: <http://www.litco.com/careers/>  
 Or e-mail resume and cover letter to [careers@litco.com](mailto:careers@litco.com)



Profile Ground Tooth  
**TIP TO TIP**

Wood-Mizer's SilverTip blade is a **TOP-PERFORMING**, economical blade for primary and secondary wood processing.

**Industrial Cutting Tools Inc.**

**866.220.8790**

702 E Chapel St.  
 Quitman, GA 31643

The Wood-Mizer quality you love. The convenience you need.



**PRSGroup**

**WE BUY, SELL AND TRADE IN USED**

# PALLET MACHINERY!

**THE MOST REPUTABLE USED EQUIPMENT DEALER IN THE INDUSTRY. WE OWN WHAT WE SELL.**

<p><b>Brewer Single Head Notcher</b> <b>\$7,500</b></p>  <p>Pneumatically powered continuous feed system. 20 hp, 460 V 3 PH in good condition!</p>	<p><b>Industrial Resources Pass One</b> <del><b>\$7,300</b></del> <b>NOW \$6,500</b></p>  <p>Fast 3.5 second cycle time. One person operation. Can dismantle up to 400 pallets per shift.</p>	<p><b>PTR 2300HD Baler</b> <b>\$5,800</b></p>  <p>Very nice hydraulic baler - perfect for corrugated or plastic recycling processing. In LIKE NEW condition!</p>
--	---	---

**SEE OUR WEBSITE FOR MORE USED INVENTORY LIKE:**  
*Bandsaw Pallet Dismantlers • Notchers • Pallet Stackers • Pallet Platers • Repair Lines • Rotary Dismantlers  
 Custom Conveyor Systems • Trim Saws • Stack Tipplers • Pallet Sorters • Dispensers • Stringer Splicers*

*Our inventory is constantly changing. Visit our website for up to date listings!*



**30-Day Warranty on Pre-Owned Machines and 90-Day Guarantee on Refurbished Machines!**

**(844) 892-2322 | PRSGroupInc.com**

**Need Hog Parts... NOW?**  
Don't Wait - Call The Hogman!

**Toll Free 1-888-244-0161**  
www.ellisonsales.com

## Row Electrical Equipment, Inc.

P.O. Box 2812 • Toledo, Ohio 43606

**Your Source for Used & Reconditioned:**

<ul style="list-style-type: none"> <li>• Squirrel Cage Motors</li> <li>• Gear Motors</li> <li>• Wound-Rotor Motors</li> <li>• Synchronous Motors</li> <li>• DC Motors</li> <li>• Phase Converters</li> <li>• Adjustable-Speed Drives</li> </ul>	<ul style="list-style-type: none"> <li>• Generators, AC and DC</li> <li>• Engine-Generator Sets</li> <li>• Transformers, Single Phase</li> <li>• Transformers, Three-Phase</li> <li>• Across/Line</li> <li>• Reduced Voltage Starters</li> <li>• Safety Switches</li> </ul>
---	---



**24 Hours a Day Call 800-248-4479 • We Buy Used Electrical Equipment**  
 Visit our website: www.rowelectrical.com • Email: rowelec@glasscity.net

## The Morgan Line-Up!



**Original Single Head Resaw**



**4-Head Resaw**



**Wide Cut Resaw**



**Multi-Head Trim Saw**



**Military Band Notcher**



**Board Duster**



**UNIVERSAL**  
MACHINERY SALES, INC.

*Call Mona Tracy*

**855-298-8890**  
**or 812-298-8090**

sales.universalmachinerysales@gmail.com

**PORTABLE YARD SAW**



This portable chain saw is for cutting logs or packages of lumber. It is available with electric drive or 20 HP gas engine with centrifugal clutch. It features manual or electric start.

**VERTICUT 2000-M**

Hydraulic vertical guillotine length stops can eliminate the need for a double even ending unit



**STANDARD FEATURES**

- Safety guarding
- Operator platform
- "Stellite" inlaid sawbar
- Cut accuracy of +/- .040"
- Automatic chain bar oiling
- Package alignment stands
- Standard models for 16' & 20" packages
- Hydraulically powered sawbar activation through the cut

**OPTIONS AVAILABLE**

- Laser light saw guide
- Modular package end squeeze
- Modular even ending system
- Automatic strapping system
- Modular infeed/outfeed decks
- Electronic length measurement with digital readout
- Powered carriage positioning

**HIGH SPEED CHOP SAW**



L-M high speed chop saw is available in standard sizes from 48 to 84 inches in diameter. It features a heavy-duty construction frame and saw ladder.

**LS SYSTEM 2000 LOG SPLITTER**



- Heavy duty Hydraulically powered splitter using onboard HPU.
- Adjustable travel speed using gear reduction for high torque and low power requirements.
- Splits logs up to 60" diameter by 20ft. long
- 54" vertical adjustment capability for slabs-quartering or sizing to mill capacity.

The Original



**L-M EQUIPMENT Company Inc.**  
 P.O. Box 82111,  
 Portland, OR 97282  
 Phone (503) 235-3146  
 Fax (503) 235-3916  
 1-800-228-0793  
[www.lmequipmentusa.com](http://www.lmequipmentusa.com)



Leasing available • Call for video

**DECK SAW**



Deck saw with sawbars of up to 12 feet in length are used to cut the largest of logs, and are also used to split logs length-ways.

**TRI-STATE Auction & Realty, L.L.C.**

**Our Forestry Equipment Auctions**

ATTAIN TOP DOLLAR!

• APPRAISALS • AUCTIONS • LIQUIDATIONS •



• APPRAISALS • AUCTIONS • LIQUIDATIONS •



**Specializing In Forestry Equipment Auctions  
And Certified Appraisals**

P.O. Box 567 • Kingston, Tennessee 37763  
 Phone (800) 334-4395 • Fax (865) 376-9103



Why Rely on U.S. Blades  
for Your Saws, Blades, Knives,  
Filing Room Supplies and More?

With 5 technologically advanced service centers,  
15 delivery trucks and over 75,000 square feet of  
warehouse and factory space, U.S. Blades  
consistently delivers the leading edge  
to its customers.

*From the green end to the planer mill,  
we are your single source supplier  
of high quality knives, saws,  
bandsaw blades and related  
maintenance supplies  
for sawmills.*

Authorized Dealer For



*Armstrong*



**Hampden, ME**  
14 employees  
2 delivery trucks  
15,000 sq. feet

**Northport, AL**  
12 employees  
2 delivery trucks  
10,000 sq. feet

**West Monroe, LA**  
14 employees  
3 delivery trucks  
15,000 sq. feet

**Meridian, MS**  
15 employees  
3 delivery trucks  
15,000 sq. feet

**Florence, SC**  
27 employees  
5 delivery trucks  
20,000 sq. feet

Find out why our products are  
"Feared by Trees Everywhere!"

U.S. BLADES

800-862-4544 • [www.usblades.net](http://www.usblades.net)

## Superior Drying for Grade Lumber AND Pallet Treating... BOLDESIGNS Gives You More Options and Better Performance!



Smooth interior walls/ceiling for even air flow  
Wall-to-wall heating coils for even heat distribution  
Solid cast reversible aluminum fans for better air flow  
Automatically raised baffles  
Patented Wet Air™ Venting for fuel savings of 25-30%!



All aluminum construction  
Non-corrosive mineral wool insulation  
Customized size & shape  
Easy operation, touch screen  
Windows™ based controller  
Techs onsite to train your operator  
Easier in/out open chamber access

Call **BOLDESIGNS** at **1-800-645-7001**  
P.O. Box 1586 Lenoir, NC 28645

See more at  
[www.drykilnbolddesigns.com](http://www.drykilnbolddesigns.com)

**Don't Wait... Let Us Solve Your Drying Issues Today!**

### Selling at Auction Stuart, VA – October 24<sup>th</sup>



Cat 529 Knuckleboom

See ad in this issue or call  
**1-800-334-4395** or visit  
[www.tristate-auction.com](http://www.tristate-auction.com) for more info.

### Owner Retiring – Business For Sale

Profitable KY based manufacturer of Patented Saw Guides for band resaws and sawmills.  
Includes 2,500 sq. ft. building, complete machine shop, well established customer base, 4 U.S. patents & more!  
**Owner will train buyer.**  
Call 270-925-7127 for details.

## Total Log Scale Inventory Solutions Software • Caliper • Barcode scanner • GPS • Logtags

**In Business for 70 Years!**

Now offering a complete line of tools to keep track of your inventory from start to finish

- Digitech Professional Caliper—An all-in-one rugged computer caliper that allows you to scale logs. LogScale software is designed to collect, process and report any load and log data and send that data to a Log Scale Suite for Haglof Management System's database. With it's Bluetooth capability, the Digitech Professional works with a wide range of accessories, such as a barcode scanners and GPS.
- Log Scale Suite for Haglof Management Systems - Use it to create and manage contracts, price lists, tickets and loads as well as scale logs, calculate volumes and manage log inventories.
- LogTags—Durable plastic tags with many styles available to choose from to fit your needs and let you stand out. We even carry bio-degradable tags that are safe for the pulping process.



**HAGLOF INC**  
PO Box 2548, 100 Solleftea Drive • US-39130 Madison, MS • USA • Phone +1-601-856-5119 • Fax +1-601-856-9075  
sales@haglofinc.com • www.timbercruise.com • www.logtags.com • www.haglofinc.com

**FOR SALE!**

**Precision 8-x-8-Screen**

**LEERAY & LUKE HORTON**  
**218-372-4232**  
E-Mail: llsales@frontiernet.net

### 3 Brand New GE 2002 Golden Eagle Chamfers

**In stock & ready for immediate delivery!**

Call **1-800-345-6516** or visit [www.brewermach.com](http://www.brewermach.com)

### Minimize Log Splitting

Save time and money by quickly inserting our heavy 14 ga. S-Irons into the ends of logs and timbers to reduce splitting or checking. Unique ribbed design provides greater holding power.  
Available in 4", 5" or 6".  
**QUOTES ON REQUEST**  
1-800-325-3770 fax: 636-305-1119

**WESTERN WIRE PRODUCTS CO**  
Since 1914 770 Sun Park Dr. Fenton, MO 63026  
[www.westernwireprod.com](http://www.westernwireprod.com) sales@westernwireprod.com



**MORBARK® Hosts Demo Days, Welcomes Guests From Around The World**

\*\*\*\*\*

Morbark, Inc. welcomed approximately 300 customers, members of its authorized dealer network, and other guests from around the world for its ninth Demo Days event on August 20 and 21. Morbark's Demo Days give attendees the opportunity to not only watch the equipment in action, but also meet the people who build and support the equipment as they see firsthand the manufacturing processes utilized. This year's events included factory tours, networking opportunities, vendor booths and a chance to see the equipment up close, as well as try out Morbark's Boxer® line of compact utility loaders.

The event culminated with demonstrations of equipment for the forestry and recycling markets, including its Beaver™ M20R Forestry, 30/36 NCL Track Whole Tree Drum Chipper, 40/36 NCL Whole Tree Drum Chipper, Rebuilt 50/48 NCL Whole Tree Drum Chipper, 3200 Wood Hog Horizontal Grinder, HT1042 Slow-Speed Shredder, 6600 Track Wood Hog Horizontal Grinder and 1300B Tub Grinder.

Morbark, Inc., based in Winn, Mich., has been innovating and manufacturing durable, high-performance equipment for the forestry, recycling, tree care, sawmill and biomass markets for more than 50 years. The company produces a full line of whole tree and waste wood chippers, flails, brush chippers, horizontal and tub grinders, sawmill equipment, material handling systems and more. Visit [www.morbark.com](http://www.morbark.com), "Like" us on Facebook, follow us on Twitter or subscribe to our YouTube channel.

\*\*\*\*\*



# PalMate<sup>®</sup> ERP

defining efficiency

## Revolutionizing Recycling & Timber Operations

- Simplified inventory management
- Paperless BOL processing
- Streamlined production & delivery scheduling
- Track piece rates & productivity
- Forklift mounted tablet PCs and Bluetooth scanners

[www.PalMateERP.com](http://www.PalMateERP.com)

Automated Machine Systems, Inc. | 877-267-8384

## PRINTERS FOR THE PALLET INDUSTRY

**444SM-PALLET PRINTER**

- Cost-effective alternative for placement of HT, IPPC information on each and every pallet.
- Capable of mounting to automated pallet machines.
- Saves time and money compared to manually hand stamping or spraying information on pallets separately.
- Velcro backed hubs allow quick and easy changes to information placed on pallets.
- Spring tension maintains contact and even printing on every pallet.
- Fully adjustable.
- Permanent stamps and information.
- 7 different colors of ink and ink rolls available**

**CLAUSSEN ALL-MARK INC.**  
 8795 Grissom Pkwy. - Titusville, FL 32780  
**PHONE: 800-252-2736 FAX: 321-607-5071**  
 Email: [sales@claussenallmark.com](mailto:sales@claussenallmark.com) • [www.Claussenallmark.com](http://www.Claussenallmark.com)

**Turn Your Surplus Equipment Into CASH**

*We pay top dollar for good used equipment.*

Go to our website for an up-to-date listing or call us at **800-241-8983**

**Ben Jones Machinery**  
Div. of Dickert Enterprises, Inc.  
 Industry's Most Trusted Source

**UPDATED DAILY!**  
[www.benjones.com](http://www.benjones.com)  
 E-Mail: [sales@benjones.com](mailto:sales@benjones.com)

# TRI-STATE AUCTION & REALTY, LLC

## EQUIPMENT AUCTION BEILER SAWMILL

3276 ROARING SPRINGS RD ■ CADIZ, KENTUCKY 42211

**DIRECTIONS:** From I-24 take exit 73. Then take Hwy 117 South for 1 mile to stop sign. Turn right on Hwy 164 West, go 9 miles and mill on right.

**THURSDAY • OCTOBER 15, 2015 • 10:00 AM CST**

*NOTE: Mr. Beiler has decided not to build his mill. Lot of the equipment has been rebuilt and most is out and ready to load. 10% onsite & 13% online Buyers Premium added to the final bid price on all items. Live online bidding will be available at [BidSpotter.com](http://BidSpotter.com). All sales are final and buyer is responsible for removal of equipment. All announcement made on auction day take precedence over any/all written material. All buyers paying with a company or personal check must have a bank letter with statement of limits. We DO NOT accept credit/debit cards. NO Phone bids for this auction.*

- NEWLY REBUILT CLEEREMAN
- MELLOTT DEBARKER
- CEDAR CREEK EDGER
- TRUCKS
- TRAILERS
- LOWBOYS

APPRAISALS • AUCTIONS • LIQUIDATIONS

APPRAISALS • AUCTIONS • LIQUIDATIONS

**SAWMILL:**

*NOTE: Majority of this equipment has not been installed and is ready to load. All equipment must be moved from the property before October 30, 2015.*

- Cleereman Model 36 4 HB Carriage, S/N-36-794-03, Rebuilt by Bissland; Not Run Since Rebuild, w/Lube Sys.; Valve Heater; 4 Brownsville Turners; Track; Pantagraph; Controls
- All Steel Husk Frame w/Off Bearing Belt
- New Hydraulic Carriage Drive w/ Drum Package
- Rebuilt Cedar Creek 3 Saw Vertical Edger w/Hydraulic Drive
- Vibrating Conveyor, 13" x 48' w/ Drive
- Vibrating Conveyor, 13" x 106', w/Drive



**2004 Mack Road Tractor**

- 3 Lumber Carts
- Lot of Lumber Rolls
- Unscrambler, 4 Strand, w/Hydraulic Drive; w/7' 2 Strand Package Deck
- Suction Blower 36", w/8' Cyclone; w/ Blow Pipe
- Corley 642 5 Saw Edger, S/N-68-S63-SA48-001, w/1 Moveable Saw; w/In-feed; w/Outfeed Belt
- Mellott 13' Slab Drop w/4 Arm Cant Catcher; w/Hydraulic Drive
- Pop Up Transfer, 5 1/2' 3 Strand, w/Drive
- Green Chain, 40' 3 Strand, w/#78 Rooftop Chain; w/Hydraulic Drive; w/Pop Up Discharge Rollcase
- Mellott 24' Endwise Log Conveyor w/110 Ladder Back Chain; w/4 Arm Kickers; w/Hydraulic Drive
- Morbark 24' Endwise Log Conveyor w/ Cat Track Chain; w/4 Arm Kickers; w/ Hydraulic Drive

- Morbark 22' Endwise Log Conveyor w/110 Ladder Back Chain; w/Hydraulic Drive
- Rebuilt 2003 Mellott Rosser Head Debarker, S/N-03200424, w/Cleereman 4' x 4' Control Cab
- New Waste Conveyor, 170', No Chain or Drive
- Patz 40' Barn Sweep w/Extra Chain
- Mellott 10' 4 Strand Collector Deck w/81X Chain; w/Air Operated Stops; w/ Hydraulic Drive
- Heavy Duty 24' 4 Strand Incline Log Deck w/Chain; w/Log Lugs; w/Electric Drive
- New 60' 4 Strand Log Deck, 16' Wide, w/5 Arm Stop & Loader; w/New Chain; w/Drive
- Barn Sweep, 140', w/Steel Frame; w/ Drive; w/Chain with Drags
- Air Operated Chop Saw



**Clark Forklift**

- 2004 Freightliner w/435 Mercedes Engine w/Overhaul; w/ Jake Brake; w/Wet Line Kit; w/Air Ride; w/11R22.5 Rubber on Aluminum Budd Wheels
- 2004 Mack Day Cab Road Tractor w/427 Engine; w/10 Speed Transmission; w/Jake Brake; w/Aluminum Headache Rack
- 2006 Trail King 35 Ton Detachable Lowboy, 102" Wide, w/Winch; w/ Rear Hydraulic Fold
- 2000 ProTrack 35 Ton 102" Wide Lowboy w>Loading Ramps
- 1994 Talbert Tri-Axle 55 Ton Detachable Lowboy
- 2006 Fontaine 48' x 102" Combo Drop Deck Spread Axle Trailer w/ Air Ride
- 1996 Trailmobile 48' x 102" Spread Axle Drop Deck Trailer
- 1994 Utility 53' x 102" Curtain Side Trailer



**Rebuilt Cleereman Carriage**

- Detroit 60 Series Power Unit w/PTO; Rebuilt Engine; w/400 Hours
- New 600 Gallon Hydraulic Tank; 3 New Hydraulic Pumps and Controls
- New Hydraulic Cooling System w/Radiator
- Mellott Rollcase, 24" x 20', w/8" Rolls; w/Stop Gate; w/Hydraulic Drive; w/4 Strand Pop Up Transfer w/Hydraulic Drive



**2006 Fontaine Trailer**

- Jack Shaft w/Hydraulic Pump
- Clean Burn CB500 Waste Oil Burner, Model CB-525-52
- (3) Double Wall Oil Tanks



**Case 1150E Dozer**

**ROLLING STOCK:**

- 1988 Case 1150E Dozer, S/N-JAK0012545, w/Enclosed Cab; w/6 Way Blade; w/Winch; 2700 Hrs
- John Deere 444 Wheel Loader w/Forks and Clamp; S/N- 70093
- Clark 8,000 Lb Forklift w/Propane Gas Engine; w/5' Forks; w/3 Stage Mast; w/ Shuttle Transmission



**Talbert 55 Ton Lowboy**

**Check website for complete listing & additional photos**  
[www.tristate-auction.com](http://www.tristate-auction.com)

**BidSpotter.com**  
Live Interactive Auction Website!  
KY LIC. #7048

JOHN C. KIMBEL, JR.  
**TRI-STATE**  
AUCTION & REALTY, LLC

P.O. Box 567 • Kingston, TN 37763  
TOLL FREE 800-334-4395 or  
865-376-7009 Fax: 865-376-9103  
E-MAIL [auctions@tristate-auction.com](mailto:auctions@tristate-auction.com)  
Visit Our Web Site [www.tristate-auction.com](http://www.tristate-auction.com)

**Terms:** Cash, cashiers check, all personal or company check must have bank letter of guaranty. Complete payment is due day of auction. Sold As Is, Where Is. No Warranty or Guarantee is Expressed or Implied. Announcement made day of auction will take precedence over any written material.

**TRI-STATE CERTIFIED INDUSTRIAL APPRAISERS**

# TRI-STATE AUCTION & REALTY, LLC

## EQUIPMENT AUCTION

**SURPLUS EQUIPMENT TO THE CONTINUED OPERATION OF  
WHITLOW EXCAVATING & LOGGING, INC.  
AND SOUTHEASTERN LAND & LOGGING, INC.**

1463 FAIRSTONE PARK HWY ■ STUART, VIRGINIA 24171

**SATURDAY • OCTOBER 24, 2015 • 10:00 AM EST**

*Note: There will be a 10% onsite and 13% online Buyers Premium added to the final bid price on all items sold. We will not be taking phone bids for this auction as there is NO Cell Phone service at auction site. All sales are final and buyer is responsible for removal of equipment. All announcement made on auction day take precedence over any/all written material.*

- CUTTERS
- SKIDDERS
- LOADERS
- DOZERS & EXCAVATORS
- FARM EQUIP.
- TRUCKS & TRAILERS
- MISC. ITEMS

**APPRAISALS • AUCTIONS • LIQUIDATIONS**

**APPRAISALS • AUCTIONS • LIQUIDATIONS**



**CAT 573**

**CUTTERS:**

- 2011 Cat 573 Feller Buncher; S/N-HA19996; w/2160 Hours; w/Prentice S-57 22" Sawhead; S/N-PAW00173; Offered Subject to Reserve
- 1998 Hydro Ax 611EX Feller Buncher; S/N-6237; w/4700 Hours; w/Hydro Ax 22" Sawhead; S/N-4073



**JOHN DEERE 548GIII**

**SKIDDERS:**

- 2006 Cat 525 Grapple Single Arch Skidder; S/N-3KZ0203; w/12,000 Hours; w/30.5 Rubber
- Cat 525 Single Arch Grapple Skidder; w/30.5 Tires; w/Chains
- 2001 John Deere 548GIII Single Arch Grapple Skidder; S/N-580952; w/Heat & Air Cab; w/Air Ride Seat; w/13,300 Hours; w/23.1x26 Rubber; Engine & Transmission done with between 9,000 & 10,000 Hours
- 1998 John Deere 648GII Single Arch Grapple Skidder; S/N-567490; w/9800 Hours; w/Heat & Air Cab; w/30.5 Rubber; w/Winch; w/Chains
- 1998 Timberjack 460 Single Arch Grapple Skidder; S/N-985189; w/12,700 Hours; w/Winch

- Timberjack 240 Skidder; S/N-4373; w/Detroit Engine; w/Manual Transmission; w/Gearmatic Winch; w/New Style Transfer Case; w/18.4x26 Rubber
- Timberjack 240 Skidder; S/N-242546; w/Manual Transmission; w/Detroit Engine; w/Gearmatic Winch; w/18.4 x 26 Rubber
- (4) Firestone Forestry Special Tires for Timberjack Skidders, 28Lx26 w/Timberjack Wheels
- (3) Cat 525 Wheels
- Wheel for Cat 518
- Bear Claw Chains for 28L Rubber



**CAT 529**

**LOADERS:**

- 2012 Cat 529 Knuckleboom; S/N-PR65225; Less than 40 Hours w/Joy Stick Controls; 29' KB; 9" Mounting Knuckle; V Bolt-On Heel; w/Continuous Rotation Grapple, 4548Sn-R50, GR22791; w/Saw Package Hookup; w/3300 # Counterweight; w/(2) Halogen Boom Lights; w/Cat 6.6 156 HP Engine; (2) Halogen Boom Lights; Heat/Air Cab; AM/FM/CD/XM Radio; Mounted on International Paystar Tandem Axle Truck; Offered Subject to Reserve
- Prentice 410E Knuckleboom Loader; S/N-53560; w/Saw Package Hookup; w/Joy Stick Controls; w/Cummins 6BT Engine; w/CTR 314 Delimber; Trailer Mounted
- CTR-42I Short Frame Sawbuck
- Barko 160B Knuckleboom Loader; w/John Deere 6 Cylinder Engine; w/Saw Package Hookup; Trailer Mounted
- CTR-42IP Reversible Sawbuck; S/N-20953
- 2014 Cat 259D Skid Loader; S/N-CAT0259D K0FTL00657; w/Conversion Arrangement; w/2 Speed, D/S Idler; Track; 15.7" Rubber; w/Rops Enclosed Cab with Heat & Air; w/Air Suspension; w/Radio; w/AM/FM, CD, Bluetooth, Display,



**2014 CAT 259D**

- Advanced, LCD, Camera, Seat Belt, w/Bucket & Forks; w/432 Hours; Remaining 3 Year 1500 Hr Major Powertrain Warranty
- Cat 70" Quick Attach Bucket; Model 270-M370
- Quick Attach Forks for Skid Loader
- Quick Attach Grapple for Skid Loader; Model 286-9300; S/N-PRSS9R000682
- Harley Rake for Skid Loader; Model PR-184; S/N-PRW00944
- 2013 Cat Bush Hog for Skid Loader; Model BR-72 Brush Cutter; Less Than 10 Hours
- 1993 Cat 953B Track Loader; w/4 Way Bucket; w/9,550 Hours; S/N-5MK01100

**DOZER & EXCAVATORS:**

- Cat D5H High Track Dozer; S/N-8RC0090; w/10,000 Hours approx...; w/6 Way Blade
- 2001 Cat 315CL Track Excavator; S/N-0CFT00594; w/6680 Hours; w/Hydraulic Thump; Rotating Shear;
- 4' Bucket for Cat 315 Excavator
- 2' Bucket for Cat 315 Excavator; w/New Style Teeth
- 2014 Kubota KX057-4R3A Track Excavator; w/Hydraulic Thumb, Q-Coupler; w/Grader Blade; Less Than 105 Hours; S/N-25467; w/Heat & Air Cab
- 18" and 36" Bucket for Kubota
- (2) Extra Buckets for Cat 325 Excavator
- Altec Model LB-650 50' Tele Bucket; S/N-1189-S0543; Not Installed
- Hamm HD 10 Roller w/Diesel Engine; w/Vibrator

**FARM EQUIPMENT:**

- John Deere 6310 4x4 Tractor; w/640 Front End Loader; w/Heat & Air Cab; w/Air Ride Seat; w/1195 Hours; S/N-L06310V306656
- Fork for quick Attach John Deere Tractor
- Bush Hog 8' 6 Way Grader Blade; Model 121; Less than 10 Hours; Will Fit John Deere Tractor
- 7' Bucket for John Deere Tractor

- John Deere 457 "Megawide" Baler; w/Computerized Control; Net or String; 3000 Rolls on Baler
- Bale Chopper w/Gas Engine



**2014 KUBOTA**

**MISCELLANEOUS:**

- Power Unit, 3 Cylinder Diesel Engine
- Extra L Shaped Fuel Tank
- 30' 2 Section Bridge, Each Section 5' Wide
- (14) Mats, 10' x 14' Long

**TRUCKS & TRAILERS:**

- 1996 Mack RD690S Tandem Axle Log Truck; w/Mack Engine; w/7 Speed Transmission; w/Jake Brake; w/44K Rears
- 1993 Mack DM690 Road Tractor; w/Mack Engine; w/7 Speed Transmission; w/Jake Brake; w/44K Rears; w/A/C Cab
- 1984 Mack R Model Tandem Axle Log Truck; w/Log Bunks; w/300 Mack Engine; w/9 Speed Transmission; w/Air Condition; w/Air Ride Cab
- Bumper w/Winch for Mack Truck
- (2) Hydraulic Winches
- 1998 Eager Beaver Pentle Hook Lowboy; w/Dove Tail Loading Ramps
- 1999 Tag-A-Long Trailer; Shop Built
- Pulp Trailer

**Check website for complete listing & additional photos**  
[www.tristate-auction.com](http://www.tristate-auction.com)



VA FIRM LIC. #2906-000193

JOHN C. KIMBEL, JR.  
**TRI-STATE AUCTION & REALTY, LLC**

P.O. Box 567 • Kingston, TN 37763  
TOLL FREE 800-334-4395 or  
865-376-7009 Fax: 865-376-9103  
E-MAIL [auctions@tristate-auction.com](mailto:auctions@tristate-auction.com)  
Visit Our Web Site [www.tristate-auction.com](http://www.tristate-auction.com)

**Terms:** Cash, cashiers check, all personal or company check must have bank letter of guaranty. Complete payment is due day of auction. Sold As Is, Where Is. No Warranty or Guarantee is Expressed or Implied. Announcement made day of auction will take precedence over any written material.

**TRI-STATE CERTIFIED INDUSTRIAL APPRAISERS**

**TRI-STATE AUCTION & REALTY, LLC**

**EQUIPMENT AUCTION**

**BRANSON DUNLAP SAWMILL, LLC**

48 CR 5280 ■ BOSS, MISSOURI 65440

**SATURDAY • NOVEMBER 7, 2015 • 10:00 AM CST**

*Note: There will be a 10% onsite & 13% online Buyers Premium added to the final bid price on all items. Live online bidding will be available at [BidSpotter.com](http://BidSpotter.com). All sales are final & buyer is responsible for removal of equipment. We do not accept credit/debit cards.*

- CLEEREMAN MILL
- RESAWS
- SCRAGG
- NEW CEDAR CREEK EDGER
- LOGGING EQUIPMENT
- LOADERS
- TRUCKS
- TRAILERS

**APPRAISALS • AUCTIONS • LIQUIDATIONS**

**APPRAISALS • AUCTIONS • LIQUIDATIONS**

**SAWMILL:**

- L & M Vertical Cut V2000 Pkg Saw; w/15 HP Mtr on Head; w/Hyd Power Pack; S/N-22016
- Helle 27' 4 Strand Log Deck; w/4 Arm Stop & Loader; w/Hyd Drive; 7 1/2 Wide
- Cleereman Model 36 3 H/B Carriage; S/N-36-235; w/Track, Pantograph & Controls; Rebuilt by Cleereman in 2006, Kept in Dealers Warehouse, Sold in 2014, Run 1 Year
- Cleereman 50 HP End of Track Hyd Carriage Drive
- New Cedar Creek 75 HP 3 Saw Vertical Edger; w/Torch Screen Set; NI
- Helle 4' x 5' Control Cab
- Helle All Steel Husk Frame
- Custom Built Rotary Log Turner
- (4) 56" Circle Saws
- Barn Sweep, 30' & 40' w/Drive
- Lumber Belt 25" x 20' w/Drive
- Edmiston 30" Edger; w/Hyd Set; S/N-HE385-E; w/Infed; w/Outfeed; w/Hyd Power Pack; w/100 HP Mtr
- Mellott 24" x 24' Rollcase
- Mellott Green Chain, 30' 2 Strd
- (15) All Steel Lumber Rollouts
- (2) Morgan Manual Chop Saws
- Morgan 2 Saw Edger
- Kent 12' Turn Table, Electric Drive
- Morgan 2 Saw Scragg Mill; w/(2) 40" Saws; w/Dual Belt; w/Sharp Chain Infeed; w/Motor & Controls
- Phelps Model 45HV-1 Trailer Loading Sys; 30 HP
- Quality 20' 2 Strand Log Deck
- Morgan Single Head Resaw



**John Deere 843K Feller Buncher**

- Kent 50' 3 Strand Outfeed Transfer; w/Hyd Drive
- Kent Double Head Notcher; w/Feeder Sys; w/(2) 30 HP Motors
- Bullard Vertical Turret Lathe
- (5) 4 Sided Portable Material Racks
- (2) Jockey Grinders
- Banding Carts & Banding Tools

**CUTTER:**

- 2010 John Deere 843K Feller Buncher; w/ FD 22B Saw Head; w/1164 Hrs; Sold by Dealer in 2013

**SKIDDERS:**

- 2006 Prentice 490 D/A Grapple Skidder; w/10,000 Hrs
- 2008 John Deere 848H D/A Grapple Skidder; w/7682 Hours
- Cat 515 Grapple Skidder
- Franklin Q70B Skidder; w/9935 Hours
- Essco Grapple for Franklin Skidder



**Cat D6H Dozer**

- (2) New Firestone 30.5 Skidder Tires

**LOADERS & DOZER:**

- 2009 Husky Brute XL335 KB Loader
- 1999 Husky XL235 KB Loader; Trailer Mounted
- John Deere 437C KB Loader; w/11,988 Hrs
- Riley 4300 Sawbuck
- CSI Sawbuck
- John Deere 444G Wheel Loader; w/JB Quick Attach Forks & Bucket
- 2006 Volvo L60E Wheel Loader; w/Forks & Bucket
- John Deere 444E Wheel Loader; w/Forks & Bucket
- Volvo L50 Wheel Loader; Needs Eng Rebuilt
- 1988 Cat D6H High Track Dozer



**Volvo L60E w/Quick Attach**

**TRUCKS & TRAILERS:**

- 2010 KW W900 Day Cab Road Tractor; w/Cummins Eng. ISX 485
- 2007 Int'l Model 5900ISFA Day Cab Road Tractor
- 1998 Int'l 4700 T444E Crew Cab Utility Truck
- 1999 KW T/A Log Truck; w/Cat 550 Eng., Just Rebuilt; w/Rear Mounted Serco 8500 KB
- 1996 KW Day Cab Road Tractor
- 1996 Fontaine 50 Ton Detach Tri-Axle Lowboy
- 2003 Pitts 45' Log Trailer
- 2005 Pitts 42' Log Trailer
- 1999 Sparta 40' Log Trailer
- 2006 Pitts Pulp Log Trailer
- 2001 Pitts Pulp Trailer
- 1999 Raven 102" x 48' Alum Flatbed S/A Trailer
- 1985 East 45' Alum S/A Flatbed
- 2004 Peerless 42' Open Top Trailer
- (2) 1994 Peerless 40' Chip Trailers
- Pole Trailer, Tandem Axle



**2010 Kenworth Tractor**



**Kent 5 & 6 Head Resaw**

- Morgan Double End Trim
- Precision 21' Vibrating Conveyor
- Belt Conveyor 24" x 30'
- IR 15 HP Tank Mounted Air Compressor
- Phelps Dust Sys for Kent Resaw
- Montgomery Blow Hog w/100 HP Motor
- (1) 3 Head Block Helle Mill w/Track; NI
- (1) 2 Head Block Helle Mill; NI
- Baker 40' 2 Strand Transfer; wC55 RT Chain; w/Drive
- Extra 75 HP & 150 HP Motors
- Square D MCC w/150 HP Reduced Voltage Starter; w/1600 Amp Disc
- Kent 6 Head Band Resaw; w/30 HP Motor; w/Multiple Starter Box; w/Controls; w/7.5 HP Hyd Power Pack
- Kent 5 Head Band Resaw; w/30 HP Motors; w/Multiple Starter Box; w/Controls; w/7.5 HP Hyd Power Pack
- Saws for Kent Resaw
- Kent 4 Saw Multiple Trim Saw; w/(4) 15 HP Mtrs; w/20" Saws; w/Block & Stock Conv; w/Computerized Controls; w/Multiple Starter Box; w/5 HP Hyd Power Pack
- (11) Saws for Trim Saw
- Kent 14' 2 Strand Infeed Deck; w/Double 4 Strd Unscrambler Sys; w/5 HP Hyd Power Pack
- Kent 10" x 8' Belt Conveyor; w/Hyd Drive
- Kent Vertical Resaw; w/30 HP Motor; w/Controls
- (2) Kent 7" x 20' Slat Conveyors; w/Hyd Drive
- Kent 20" x 170' Belt Conveyor; w/Drive
- Kent 20' 3 Strand Infeed Transfer; w/Hyd Drive
- 36" Suction Blower; w/Approx 30 HP Motor

JOHN C. KIMBEL, JR.



P.O. Box 567 • Kingston, TN 37763

TOLL FREE 800-334-4395 or 865-376-7009 Fax: 865-376-9103

E-MAIL [auctions@tristate-auction.com](mailto:auctions@tristate-auction.com)

Visit Our Web Site [www.tristate-auction.com](http://www.tristate-auction.com)

**Check website for complete listing & additional photos**  
[www.tristate-auction.com](http://www.tristate-auction.com)



TN FIRM LIC. #1129

**Terms:** Cash, cashiers check, all personal or company check must have bank letter of guaranty. Complete payment is due day of auction. Sold As Is, Where Is. No Warranty or Guarantee is Expressed or Implied. Announcement made day of auction will take precedence over any written material.

**TRI-STATE**

**CERTIFIED INDUSTRIAL APPRAISERS**



**Dismantling  
BARS**  
"LIFETIME WARRANTY"

from... **PRS**  
PALLET REPAIR SYSTEMS, INC.

**SAME DAY  
IN STOCK  
SHIPMENT**

Pallet Repair Systems, Inc. • 3550 Mayflower Blvd. • Springfield, IL 62707  
PHONE: 217.291.0009 FAX: 217.291.0008  
TOLL FREE: 866-546-8864 www.pallet-repair.com

**When You Buy Your Circular Saws From B.H. Payne –  
You've Bought The Best . . .  
We Guarantee It!**

Here's What You Get With EVERY B.H. Payne Saw –

- Saws manufactured from only the Highest Quality Nickel Alloy Steel
- Each Saw Milled With State-Of-The-Art Precision CNC Milling Machine
- We Tension Your Saw to Your RPM **BEFORE** Leaving Our Factory
- Complete Guarantee of Your Satisfaction

**We Are Hanchett Distributors**

*We Manufacture & Sell Inserted Tooth Headsaws, Solid Tooth Saws, Inserted Tooth Cutoff Saws, Carbide Saws & Wide Band Saws. We Also Stock And Sell Bits & Shanks, Carbide Tips, Diamond Wheels, Knife Grinding Wheels, Saw Gummung Wheels, Knives, Babbitt & Babbitt Pots, "Lubie" Lubricants, Machine Parts for Various Filing Room Machines & More!*

**B.H. PAYNE & COMPANY, INC.**  
P.O. BOX 90608, East Point, GA 30364  
404-761-8711 FAX 404-761-5398  
"Traditional Quality Combined With Today's Technology"  
**Call 800-752-0627**

www.paynesaws.com



Make Sure To Ask For Our Free, Complete Saw Catalog

**Ramp Up Your Firewood Business!**

**Start or Expand your Firewood Business**

**The Log Buster!**



**Model 2040xp2 – The Premier High Volume Firewood Processor**



**Model 1610EZ - Joystick control, gas or diesel, live deck or log lift, ultra mobile with integrated conveyor.**



**Quarter Oversize Logs for further processing...**

- 115 HP engine
- Over 100 tons of brute splitting force.
- Chip, Grind, Pulp, Firewood, Biomass & More!

**MULTITEK NORTH AMERICA, LLC**  
Prentice, WI 54556-0170 USA • 800-243-5438 • e-mail: sales@multitekinc.com • www.multitekinc.com

Paul Bunyan Show Oct. 2-4th Cambridge, OH

Stop making \$20 a ton SAWDUST and  
**START MAKING \$100+ TON LUMBER**

Find out more at  
**www.brewcoinc.com**

**BREWCO**  
THE PIONEER OF THE THIN-KERF RESAW

HEADQUARTERS:  
607 Front St. • Central City, KY 42330  
800.237.6880

**Bandsaw Blades!**  
*Custom Welded – Immediate Shipment  
Call for prices and sizes available.*

**LENOX** & **WOODMASTER**  
**MORSE** & **KASCO SharpTech**

SHARPENING SERVICES NOW AVAILABLE FOR 1", 1 1/4", 1 1/2", 2" BANDS

**W-37 Wright Grinder**  
A compact, automatic grinder that is quick to set up and simple to operate. Precision cams produce excellent sharpness.



**U-CUT Enterprises**

4800 SOLVAY RD - JAMESVILLE, NY 13078  
**1-800-952-8288**  
WWW.U-CUT.COM



**DOUBLE-CUT  
SAWMILLS**

**Extremely  
Fast!!**

**NEW Reduced  
US Prices**

**FOR 2015**

Complete Sawmill Layout Options with full line of accessory equipment for the first transformation of wood

**HELPING YOU TO GROW YOUR BUSINESS**



**BARTLETT'S SAW SERVICE —  
Now Offers 4 to 8" Wide Bandsaw Blades...  
Available in Single & Double Cut, 1 3/4" to 2" Tooth Space**

- Our saws are **GUARANTEED** to run right out of the box!
- We offer **QUICK DELIVERY** with over 60 years combined experience.
- Bartlett saws are built by life-long saw filers.

*Since 1978, the Bartlett Family has been providing superior parts, supplies and service to circle & wide band sawmills throughout the U.S. Everything we manufacture and sell must meet our strict standards.*



621 US 41A • Henderson, KY 42420  
e-mail: eric@bartlettsaw.net

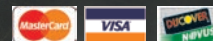

**Call us today at 800-566-0319 to place your order or to discuss your sawing issues.**

**Ask About \* Shanks \* Edger Saws \* Saw Bits... and Lots More!**



**SAWMILL DIVISION TO BE OFFERED IN IT'S ENTIRETY OR PIECEMEAL**  
**FORMERLY ST LAWRENCE LUMBER INC.**  
**3264 State Route 54, Gouverneur, NY 13642**  
**OCTOBER 9th, 2015 • 10AM EST**

- 18' Mellott 4 Strand Deck with Stop Loader
- Mellott Debarker, 30 HP Motor on Head, 55' Log Trough, Outside, 23' Log Trough with Kickers, Inside
- 30' Mellott 4 Strand deck with Stop Loader, Feeding Carriage
- #6 Mellott Log Turner
- Helle 4 Knee Carriage with 57' Track
- Helle 60 HP Hydrostatic Feed
- (7) Head Saws, 54"/56"
- Mellott Off Bearer Reckart Drop Belt with 4 Pin Cant Catcher
- 83' Reckart Roll Case, 10" Rolls, 2 Transfers (Used very little, Paint is still on rolls)
- 30' Reckart 4 Strand Cant Deck w/Stops
- Brewco B-1600 w/Complete Runaround w/4" and 2" Wheels (Used very little, Paint is still on rolls), 75 HP Mtr, 5" Band
- (44) 5" Resaw Blades for Brewco
- (46) 2" Resaw Blades for Brewco with Sharpener & Setter
- 2" Band Wheels for Brewco
- 23' Mellott Spiral Roll Case off Brewco
- Mellott 16' 4 Strand Transfer to Left Side of Edger
- Reckart 6"x42" Edger, 2 Moveable & 1 Fixed Saw with Laser Lights (3 Sets of Carbide Tip Strobe Saws Included)
- Mellott 32' Long x 2' Wide Belt Transfer from Brewco to Roof Top Green Chain
- Mellott 60' Long 4 Strand Roof Top Chain
- 20' Tailing belts from Reckart Edger
- Pendu High Speed 2 Saw Trimmer purchased new December 2014
- (10) New Lumber Carts
- (5) Used Carts
- VibraPro Vibrator 123' Long Section
- VibraPro Vibrator 45' Long Section with Sawdust Separator, Built in Magnet & Fiberglass Section w/MDI Metal Detector
- Sawdust Blower
- (2) Forestry Systems Hand Held Computers w/Printers & Chargers, Log Scaling & Block Tallying Programs
- 58" Morbark Chipper, 150 HP Motor
- (2) Belt Conveyors for Chips & Mulch
- Reckart Chip Screen & Cyclone, Chip Screen has never been used
- 30 HP Screw Air Comp w/Tank & Dryer
- Diesel Generator
- JBC 540 Loader with Forks & Buckets
- Cat 910 Wheel Loader with Bucket & Forks
- 210 Prentice Log Loader with Ford Yard Truck
- Pitts 45' Tri Axle Log Trailer
- 1980 International Tri Axle with Log Lift Loader Rotobec Log Lift Grapple
- 5,000 Breeze Dried Stickers
- All Electrical is 480 Volts
- All Tools & Extra Parts in Filing Room
- Office Trailer with Furnishings

**ATTENTION: EVERY piece of this is in NEARLY NEW Condition! Paint is not even worn off!**



Bid Live Online via [www.proxibid.com](http://www.proxibid.com)

**VISIT OUR WEBSITE**  
**ASSOCIATEDAUCTIONCOMPANY.COM**  
**FOR UPDATED INVENTORY LISTING**

Join Our Mailing List! Call or E-mail for Complete Brochure!



**ASSOCIATED AUCTION & LIQUIDATION CO.**  
 PO Box 147 Clarksburg, TN 38324  
 Fax: 731-986-4529  
[sales@associatedauctioncompany.com](mailto:sales@associatedauctioncompany.com)  
**Toll Free: 800-598-3651**

Tommy Ingram, TN AUCTIONEER# 3965 TN FIRM# 5524

**TERMS:** Full Payment day of Auction either by cash or cashiers check. Personal or Company checks will only be accepted when accompanied with an irrevocable verifiable bank letter of guarantee with statement of limit. Full payment must be made before leaving the sale location. Equipment sold "AS IS - WHERE IS" with no expressed or implied warranties. Sale Day Announcements will take precedence over any written material. 10% Buyers premium On Site, 13% Buyer Premium Online & Phone Bidders.



**EXCESS ASSETS TO THE SUCCESSFUL ONGOING OPERATIONS OF**  
**REPLOGLE ENTERPRISES**  
**2040 LUMBER ROAD, HENRY, TN**  
**OCTOBER 10th, 2015 • 10AM CST**

- HUSKY BRUTE XL235 ELECTRIC KB LOADER MDL XL235PE S/N 59399 JOYSTICK CTRLS
- 52' 3-STR LOG DECK w/STOP & LOAD
- PRECISION 848 ROSSERHEAD DEBARKER S/N 849 w/CAB & CTRLS
- 30' ENDWISE LOG TROUGH CONV 4 ARM KICKER w/MTR & DR
- 42' DRAG CHAIN BARK CONV w/MTR & DR UNDER DEBARKER
- 43' DRAG CHAIN BARK CONV w/MTR & DR
- 20 HP HYD UNIT UNDER 1ST DEBARKER
- 50' 3-STR LOG DECK w/S-N-L MTR & DR
- PRECISION 636 H ROSSERHEAD DEBARKER S/N 558 w/CAB & CTRLS
- 35' BARK CONV DRAG CHAIN UNDER DEBARKER w/MTR & DR
- 36' ENDWISE LOG TROUGH CONV w/120 LADDERBACK CHAIN MTR, DRIVE w/4 ARM KICKER
- 1ST MILL:**
- 40' 5-STR LOG DECK w/HD ROLLER CHAIN w/MTR & DR
- SERING BAR LOG TURNER 30 HP HYD UNIT

- 20' 5-STR LOG DECK w/STOP & LOAD, HD ROLLER CHAIN, MTR & DR
- 48" CLEEREMAN 3 HB CARRIAGE, TRACK & PANAGRAPH w/SILVATECH SETWORKS & CONTROLS, LINEAR POSITIONER
- TYRONE BERRY 280 SHOTGUN FEED 150 HP
- 6' MCDONOUGH BAND MILL MECH STRAIN
- 200 HP MTR ON BAND MILL
- STARTER FOR BAND MILL GE 200 HP
- 30 HP HYD UNIT
- 68' LIVE ROLLCASE 8"X30" ROLLS, MTR & DR
- 4 ARM KICKER w/3.5 4 STRAND TRANSFER
- 12' SLAB SLIDE TO VIBRATOR
- 2 SAW EDGER w/LASER LIGHTS, 30 HP MTR w/IN & OUTFEED
- 22 STARTERS & SAFETY SWITCHES BY EDGER
- SYLVANIA 1600 AMP MAIN
- (8) STARTERS & SAFETY SWITCHES
- 2ND MILL:**
- 23' 4-STR LOG DECK w/S-N-L, MTR & DR
- BAR TYPE LOG TURNER w/20 HP HYD UNIT
- 38" CLEEREMAN 3 HB CARRIAGE TRACK PANAGRAPH & CTRLS S/N 38-942-08

- 6' SALEM BAND MILL S/N 4568-72
- 200 HP MTR
- 240 TYRONE BERRY CABLE FEEDWORKS
- 35' LIVE ROLLCASE, 24" ROLLS, MTR & DR
- A/B 200 HP STARTER BOX (3) MORE STARTER & SAFETY SWITCHES
- CROSBY 2 SAW EDGER w/50 HP MTR
- 10' 4-STR DECK, MTR & DR
- 5' 4-STR TRANSFER DECK, MTR & DR
- 6 ARM BOARD FLIPPER
- 12' 4-STR TRANSFER DECK, MTR & DR
- 12' 4-STR TRANSFER DECK w/4 ARM TIPPLE & 4 ARM KICKER ON OTHER END OF MTR & DR
- 16"X40' RETURN BELT TO EDGER
- 12' RETURN ROLLCASE, MTR & DR
- 4' 4 ARM TRANSFER TO EDGER, MTR & DR
- 30' DUST CONV UNDER EDGER, 20" WIDE DRAG CHAIN, MTR & DR
- 16' SLAB VIBRATING DECK, MTR & DR
- GOING TO RESAW:**
- 12' 4-STR DECK w/MTR & DR
- MCDONOUGH 6' LINE BAR RESAW w/IN & OUTFEED & 200 HP MTR

- 15' 5-STR RETURN DECK, MTR & DR
- 40' RETURN BELT, MTR & DR
- 15' 5-STR RETURN DECK w/5 ARM KICKER, MTR & DR
- CAB & CTRLS
- 20' 3-STR DECK, MTR & DR
- GOING TO TRIMMER:**
- 28' LIVE ROLLCASE, 16 ROLL SPIRAL ROLLS, MTR & DR
- 18' 4-STR DECK TO TRIMMER, H-78 TURTLE BACK CHAIN w/MTR & DR
- 30' 9-STR BUILT IN w/7 SAW TRIMMER & EVEN END ROLLS, MTR & DR
- 25' BELT CONV UNDER TRIMMER
- 32" BELT, MTR & DR
- 40' PRECISION VIBRATING CONV, 24" BTM, MTR & DR
- 50 HP HYD UNIT
- 78' 4-STR GREEN CHAIN, MTR & DR
- 19' 3-STR GREEN CHAIN, MTR & DR w/LUMBER SLIDE
- BESIDE MILL:**
- 55' LIVE ROLLCASE, 18" ROLLS, MTR & DR

**Just Add Logs Opportunity!  
 Offered Piecemeal and As  
 Going Concern with 12 Acres of  
 Industrial Real Estate**



**VISIT OUR WEBSITE**  
**ASSOCIATEDAUCTIONCOMPANY.COM**  
**FOR UPDATED INVENTORY LISTING**



**ASSOCIATED AUCTION & LIQUIDATION CO.**  
 PO Box 147 Clarksburg, TN 38324  
 Fax: 731-986-4529  
 sales@associatedauctioncompany.com  
**Toll Free: 800-598-3651**

**LIVE ONLINE BIDDING**  
 Bid Live Online via  
[www.proxibid.com](http://www.proxibid.com)

Join Our Mailing List! Call or E-mail for  
 Complete Brochure!

**TERMS:** Full Payment day of Auction either by cash or cashiers check. Personal or Company checks will only be accepted when accompanied with an irrevocable verifiable bank letter of guarantee with statement of limit. Full payment must be made before leaving the sale location. Equipment sold "AS IS - WHERE IS" with no expressed or implied warranties. Sale Day Announcements will take precedence over any written material. 10% Buyers premium On Site, 13% Buyer Premium Online & Phone Bidders.

TOMMY INGRAM, AUCTIONEER TN# 3965 TN FIRM# 5524





- SCHURMAN 8" COMBO GANG SAW, IN & OUTFEED, NO MTR w/CAB & SILVATECH CTRLS
- 41' 4-STR LUMBER DECK TO GANG SAW, NO CHAIN, MTR & DR
- 30' 4-STR FROM GANG SAW, NO CHAIN, MTR & DR
- 12 STARTERS, MAIN DISCONNECT & SAFETY SWITCHES 480 VOLTS
- AIR COMPRESSOR ROOM:**
- GARDNER DENVER 100 HP SCREW AIR COMPRESSOR 45,000 HRS
- ULTRA AIR- AIR DRYER w/RESERVE TANK
- 8 STARTER & SAFETY SWITCHES
- CHIPPER ROOM:**
- 66" PRECISION CHIPPER 6 KNIFE
- 200 HP ON CHIPPER
- 3'x7' B M & M SHAKER
- 200 HP STARTER FOR CHIPPER
- PRECISION VIBRATING CONV 22" BOTTOM, MTR & DR
- 50 HP PHELPS DUAL CHUTE BLOWER
- 10' DUST CONVEYOR
- 60' SPLIT LEVEL CONV TO TRAILING LOADING SYSTEM, MTR & DR
- GRINDING ROOM:**
- ARMSTRONG #4 RH BANDSAW, SHARPENER
- SIEMENS OPTIMATIC RMO 880 LEVELER - ARMSTRONG STRETCHER ROLL & HAMMERING BLOCK
- MCDONOUGH GUIDE GRINDER
- SPARE BAND SAW BLADES
- HANCHETT SIZE 406 BAND SAW SHARPENER S/N 160 w/STANDS
- BARNHART WHEEL GRINDER
- AIR SWEDGES
- WELDERS
- DUST HOG OUT BACK OF BUILDING
- RHEEM AIR CONDITIONER
- 2ND GRINDING ROOM:**
- PRECISION 3 K TUB SHARPENER
- BR BENCH GRINDER
- LOT OF CHIPPER KNIVES
- DOME KNIFE GRINDER
- GUIDE GRINDER FORSCHURMAN GANG
- CHAIN SAW SHARPENER
- BAND SAW SHARPENER CAT CLAW
- WRIGHT CARBIDE TIP SAW SHARPENER
- FOLEY POST GRINDER
- DRILL PRESS
- SPARE TRIMMER BLADES
- SPARE EDGER BLADES
- SPARE GANG SAW BLADES
- MILLER WELDER FOR BAND SAWS
- 3.7 KOLBALT AIR COMPRESSOR
- 2ND MILL:**
- 20' 3 STRAND LOG DECK, MTR & DR
- COOK BAND MILL, 2" BAND, 39' OF TRACK, MTR & CTRLS
- 32' OUTFEED ROLLCASE, 24" ROLLS, MTR & DR
- 12' 7 STRAND DECK w/MTR & DR
- 50' DUST CONVEYOR, MTR & DR
- 60" PRECISION 6 K CHIPPER
- 125 HP MTR ON CHIPPER
- 90' PRECISION VIBRATING CONV, 22" BTM, MTR & DR
- PRECISION 7' x 7' SHAKER SCREEN w/CYCLONE
- 40 HP DUAL CHUTE BLOWER
- 12' BELT CONVEYOR, 15" BELT, MTR & DR
- 42' DRAG CHAIN CONV DUST TO OUTSIDE, MTR & DR
- STARTER FOR 125 HP CHIPPER MTR
- 12 STARTERS & SAFETY SWITCHES
- PALLET SHOP #2:**
- 10' 3 STRAND DECK w/MTR & DR
- 4 STRAND UNSCRAMBLER w/MTR & DR
- 12' INFEED ROLLCASE
- CUT OFF SAW
- 20' BELT CONV UNDER CUT OFF SAW
- BREWER MDL 8112 GANG SAW, S/N 22721 w/SIZE HEAD, (2) 125 HP MOTORS, IN & OUTFEED - 4 x 4 CONTROL CAB
- STARTER BOXES FOR GANG SAW
- 7 STARTERS & SAFETY SWITCHES
- OPEN TOP TRAILERS:**
- 45' FRUEHAUF OPEN TOP TRAILER, TAG# W-13805
- 45' OPEN TOP TRAILER, TAG# V-78325
- TRUCKS:**
- 2000 INT'L TRACTOR w/SLEEPER, VIN# 2H5CHAMR61C011767
- MACK VISION 427 TRACTOR MDL CX613, VIN# 1M1AE06Y6YW003903
- MACK DAY CAB ECONODYNE, S/N 1M22N1871KW028690
- 1996 FREIGHTLINER DAY CAB, VIN# 1FUYDCKB6TL868127
- 1988 INT'L DAY CAB, VIN# 2H5FBACRXC025057
- INT'L FUEL TRUCK MDL 1510 w/FUEL PUMP
- MACK DM-600 DAY CAB, VIN# DM685S22586
- 1982 FREIGHTLINER DUMP TRUCK
- 1993 INT'L TRACTOR w/SLEEPER, VIN# 2H5FHD7R1RC082056
- 1995 INT'L DUMP TRUCK, VIN# 2H5FHAER3TC011109
- PETERBILT TRACTOR w/SLEEPER MDL 359S19, VIN# 126471
- 1997 FREIGHTLINER DAY CAB, VIN# 2FUPFSEB2UA824265
- 2007 VOLVO DAY CAB w/WET KIT, VIN# 4V4NC9EH38N499301
- 1997 FREIGHTLINER w/SLEEPER, VIN# 2FUPC8291UA640034
- INT'L DUMP TRUCK BY OFFICE
- CHEVY FUEL TRUCK
- CHEVY SCHOOL BUS
- 1983 INT'L S1900 FLATBED, VIN# 71078
- 2001 CHEVY C6500 w/SIDE CURTAINS, VIN# 1GBJ7H1B9YJ514177
- CONSTRUCTION EQUIPMENT:**
- DYNAPAC CA15 PAVEMENT ROLLER
- JOHN DEERE 690B TRACKHOE w/THUMB & BUCKET, S/N 30531
- KOEHRING TRACKHOE
- DRESSER GALLION T-500 GRADER
- GROVE MZ66B MANLIFT
- ATHEY ROAD SWEEPER IN WEEDS
- WHEEL LOADERS:**
- CAT IT28F WHEEL LOADER, S/N 3CL00106, QUICK COUPLING
- JCB 416 WHEEL LOADER, QUICK COUPLING, VIN# JCB41600K71243092
- LOWBOY & FLATBEDS:**
- 45' LUFKIN FLATBED TRAILER, NO FLOOR
- 1989 45' TRAILMOBILE FLATBED TRAILER, VIN# 1PTF71TJ7L9001260
- 1994 45' UTILITY FLATBED TRAILER, VIN# 1UYF52483SA308908
- BUILDINGS:**
- 130' x250' ALL STEEL SAWMILL BLDG. IN FRONT OF OFFICE, CLEEREMAN MILLS ARE AT
- 30' x 40' ALL WOOD BUILDING
- 38' x 45' PART ROOM BLDG., PART ROOM w/PARKER HOSE MAKING MACHINE, FITTINGS, BOLT BINS, STEEL CABINET w/PARTS, FILTERS, BEARINGS, SHIEVES, V-BELT, STARTERS, PARTS WASHER, PALLET JACK, ETC
- 45' x 70' WOOD FRAME STORAGE BLDG., METAL SIDING, IT HAS (4) CORLEY 3 HB MILLS NOT IN USE, HYD UNIT, LOT OF MTR & DR

# 2 "TIPS" FOR MONTGOMERY HOG OWNERS!!

Inventors of the  
"SHANKLESS" 2-PIECE HARDFACED HAMMERS  
Bring You  
2 TIME-PROVEN MAINTENANCE SOLUTIONS

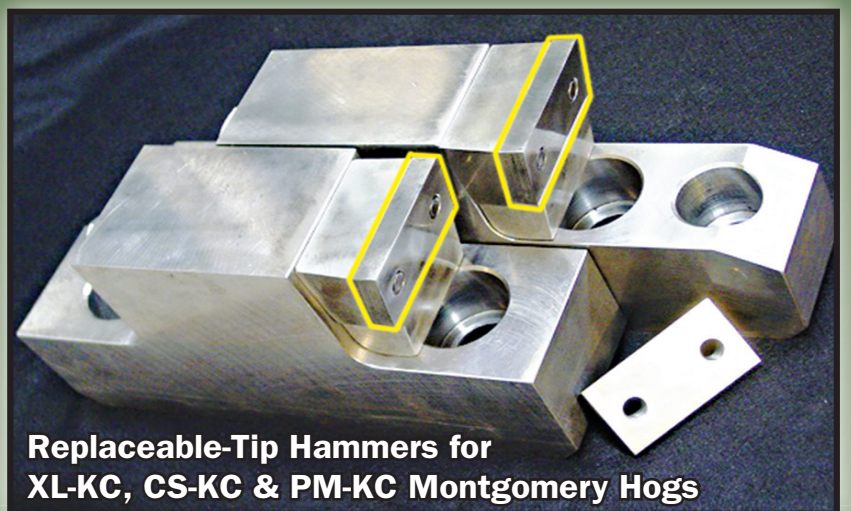

Replaceable-Tip Hammers for  
XL-KC, CS-KC & PM-KC Montgomery Hogs



Available in  
Overlapping-Cut  
& Hi-Rake Style,  
Too!

Replaceable-Tip Hammers and  
Lower Teeth for Montgomery Hogs

**PRECISION-MACHINED OUT OF OUR SPECIAL MATERIALS,  
THESE INSERTS WEAR LIKE HARDFACED PARTS!!**

- PARTS FIT - FIRST TIME, EVERY TIME!
- No more shipping parts back and forth to be rebuilt!
- No more waiting for parts to get back to you!
- No messy hardfacing welding and grinding of hammers!
- No more cracking/breaking off of hardfacing!
- You can "REBUILD" HAMMERS IN MINUTES!

Need Other Parts, Screens or Rebuilds?  
Call the experts with over 40 years experience!



**ELLISON SALES, INC.**

TOLL-FREE: 1-888-244-0161

FAX: 503-293-0816

EMAIL: sales@ellisonsales.com • WEBSITE: www.ellisonsales.com



**EXCESS ASSETS TO THE SUCCESSFUL ONGOING OPERATIONS OF  
ATLANTIC VENEER & PLYWOOD**  
2457 Lennoxville Road • Beaufort, NC 28516  
**SATURDAY, OCTOBER 24th, 2015 • 10:00 AM CST**



JENKINS CROSSCUT SAW W/STACKER MODEL 57RF  
S/N 963 - COMPLETE SYSTEM  
APPROX. 600' OF SKATE ROLLS, 19" & 36" WIDE  
JENKINS PUDDY DEFECT LINE - COMPLETE SYSTEM  
(2) BARGSTEDT PLYWOOD STACKERS  
(3) 9' SCISSOR LIFT TABLES  
SORTING LINE  
(5) SECTIONS OF 10' 2 STRAND DECKS  
(12) 14' SECTIONS OF SKATE ROLLS  
(2) 20" 2 STRAND DECKS, MTRS & DRS  
15" 2 STRAND DECK, MTR & DR  
ANTHON MODEL FG-150 DOUBLE END TRIMMER SAW  
W/INFEED  
8' OUTFEED ROLLS 58"  
(2) BARGSTEDT TRANSPORT CARTS - ELECTRIC RUN  
ON TRACK W/ROLLS  
(3) 55 GALLON DRUMS OF TURBO FLO HYDRAULIC OIL  
R046  
LOTS OF SKATE ROLLS - 19", 42", ASSORTED SECTIONS  
KOGER ROTARY VALVE  
SHELDON BLOWER  
26' 8 STRAND DECK  
MARATHON CARDBOARD COMPACTOR  
1 ROLL OF NEW BELT 24" WIDE  
(2) SWEED BAND CHOPPERS MODEL 505AD, S/N 12954  
& MODEL 510AM, S/N 41486  
SIMI PRESS  
(2) 28' AUGERS 16" MTR & DR  
ROLLERS, HOSES, SHEAVES  
8' SCISSOR LIFT TABLES  
ALTENDORF TABLE SAW  
PALLET OF QUINCY AIR COMPRESSOR PARTS  
HANKISON AIR DRYER  
SCHELLING MODEL 4800-76 TRIM SAW, S/N 1934  
PALLET OF SAW BLADES  
(10) ROLLERS  
HEESEMAN SANDER MODEL LSM4  
PALLET OF GLUE, HARDENER & ADHESIVES  
AIR TANK  
CAPITAL 36" CLIPPER  
6 SIGNODE STRAPPING MACHINE  
126" SCISSOR LIFT TABLE  
AIR RESERVE TANK  
BARGSTEDT PLYWOOD FLIPPER

HYDRAULIC TANK VENT VALVE  
SCREEN FOR CAPITAL HOG  
COOPERS AIR LOCK  
BIG JOE FORKLIFT  
AIR TANK & VALVES  
MISC. KNIVES  
CAPITAL CLIPPER 6'  
SCISSOR LIFT TABLE  
PALLET SHEAVES  
GEAR BOXES, ELECTRICAL PARTS  
FORKS  
QUINCY 235 AIR COMPRESSOR  
GOULDS PUMP PARTS  
1930 KEYWAY MACHINE  
NUMEROUS MOTORS FROM 5HP TO 150HP  
SHELVES OF NEW BEARINGS, SPROCKETS, ETC.  
PALLET OF TRACK CHAIN FOR LAIDIG UNLOADER  
LOADING SCREW CONVEYOR  
80' DRAG CHAIN CONVEYOR W/MTR & DR  
HYDRAULIC CYLINDER  
55 GALLON MINERAL OIL FOR AIR COMPRESSOR 220  
NEW BELT & NEW CHAIN  
QUINCY 350 SCREW AIR COMPRESSOR  
RIDGID PIPE MACHINE  
1981 HYMMEN GLUE SPREADER TYPE KLM  
GLUE SPREADER  
GLUE SPREADER FOR PARTS  
(2) SCISSOR LIFT TABLES & ROLLS  
CONTROL FOR LSM4 SANDER  
PUMPS & ROLLCASES  
20' STRAND DECK, MTR & DR  
ROLLCASE W/FLIPPER  
VENEER DECKS  
BARREL DOLLIES  
BAGHOUSE W/25HP BLOWERS  
SILO  
CAROLINA 20HP BLOWER  
INDUSTRIAL BOILER OIL FIRED MODEL 2FD1112502,  
S/N S12536 - COMPLETE SYSTEM  
20HP BLOWER & PIPE  
50HP BLOWER  
BAGHOUSE & SILO  
10,000 GALLON OIL TANK  
118' CONCAVE BELT CONVEYOR 24" BELT, MTR & DR

56' CONCAVE BELT CONVEYOR 24" BELT, MTR & DR  
22' LADDER BACK CHAIN CONVEYOR, MTR & DR  
CAPITAL 185" SLICER MACHINE - COMPLETE  
60' CONCAVE BELT CONVEYOR, MTR & DR  
138' X 300' ALL STEEL BUILDING  
25 VENEER CARTS  
36 PALLET OF CAPITAL SLICER PARTS & GEARS  
10' - 154" HALF ROUND BAR  
(2) 225" FLITCH TABLES W/DRIVE PULLEY  
ROLLCASES & MORE SKATE ROLLS  
KOGER BLOWER 60"  
75' CONCAVE BELT CONVEYOR  
OSECO BAGHOUSE  
MISC. HYDRAULIC TANK  
STEAM PUMP  
(4) PALLET OF 110 LADDER BACK CHAIN  
APPROX. 125 MOTORS FROM 5HP TO 150HP  
SIGNODE STRAPPING MACHINE  
MISC. ELECTRICAL BOXES, BELTING  
BARREL DOLLIES & AIR TANKS  
CYLINDER  
50HP CAROLINA BLOWER  
CAROLINA BLOWER - NO MTR  
CAROLINA ROTARY BLOWER  
CAPITAL 30" HOG  
BAKER SINGLE HEAD RESAW  
ROTARY BLOWER  
60HP BLOWER W/STAND  
LIGNA MACHINERY BLOWER 30"  
STEAM VALVES  
ROSSERHEAD DEBARKER HEAD 60HP  
GLUE SPREADER

FULGHUM HOG ON FRAME  
BAND CHOPPERS  
SKYLINE SHOW BOOTHS  
CEMENT MIXER  
NEW 16" PIPE - NEVER USED  
SIGNODE STRAPPING MACHINE  
STEEL TABLE  
(8) GEA RADIATORS  
GUARDS  
STRAPS, SLINGS  
DRYER STEEL BELTING  
PLASTIC STRAPPING  
UNLOADER  
20' AUGER  
NUMEROUS CR NATIONAL OIL SEALS OF ALL SIZES  
BEARINGS OF ALL SIZES  
BUSHINGS OF ALL SIZES  
BEARING ADAPTER SLEEVES  
TAPER LOBE BUSHING  
PILLOW BLOCK BEARINGS  
SPLIT HOUSING BEARINGS  
FLANGE BEARINGS OF ALL SIZES  
SHEAVES  
HYDRAULICS CYLINDER SCREWS  
AIR BAGS  
P&H 5 TON OVERHEAD CRANE 65' X 80'  
PRENTICE 210E KBL SELF-PROPELLED  
210 PRENTICE KBL MOUNTED ON TRAILER  
CONDENSATION RETURN STATION W/STEAM PUMP  
GOCKEL MODEL 409 KNIFE GRINDER  
20HP BLOWER & PIPE  
(3) STARTER BOXES



Join Our Mailing List!  
Call or E-mail for Complete Brochure!



**ASSOCIATED AUCTION & LIQUIDATION CO.**  
PO Box 147 Clarksburg, TN 38324  
Fax: 731-986-4529  
sales@associatedauctioncompany.com  
**Toll Free: 800-598-3651**  
TOMMY INGRAM, AUCTIONEER NC #7330

Visit our website [associatedauctioncompany.com](http://associatedauctioncompany.com) for updated inventory listing

Terms: Full Payment day of Auction either by cash or cashiers check. Personal or Company checks will only be accepted when accompanied with an irrevocable verifiable bank letter of guarantee with statement of limit. Full payment must be made before leaving the sale location. Equipment sold "AS IS - WHERE IS" with no expressed or implied warranties. Sale Day Announcements will take precedence over any written material. 10% Buyers premium On Site, 13% Buyer Premium Online & Phone Bidders.

**ARMORHOG®**  
Extreme Duty Grinder Parts

ARMORHOG® uses NITROGRIT™  
A proprietary blend of carbide  
found to best suit grinding  
applications.

ARMORHOG® is  
totally focused  
on providing top  
quality, Extreme Duty  
replacement parts for  
all brands & models  
of industrial grinders,  
specializing in rigid  
hammer grinding  
applications.

Arm Your  
Hog With  
ARMORHOG!  
Extreme duty  
aftermarket  
grinder parts  
for all grinders.

www.armorhog.com  
800.743.3491 • sales@armorhog.com  
BATTLE READY • WEAR RESISTANT • BEST VALUE

**Buy and Sell Used Equipment!**  
Just go to the **NEW amlumber.com**  
from your computer, tablet or smartphone  
and find what you need — **FAST!**

**Smicksburg Upright Band Mill**  
Plus More!  
Located in Pennsylvania  
Ad #: 16830  
**\$34,000**  
**SAWMILL EXCHANGE**  
800-459-2148  
www.sawmillexchange.com

**Frick Mill For Sale**  
Frick O1 15'  
4 Block Hand Mill  
w/Husk, Track n Ways,  
10' Mandrel w/6" Collar  
**Call 717-382-1334**  
E-Mail: sales@montgomeryequipment.com

# COMPLETE SHAVINGS SOLUTIONS!

**\$17,000**



**MINI MILL** 3-5 yds/hr.,  
Most Affordable Mill on the Market!

**\$27,950**



**BLOCK SHAVER** 7-10 yds/hr.,  
Turn loose ends in to Money!



**HU36 PORTABLE** 20-25 yds/hr.,  
52HP CAT Diesel,  
**Call For Price!**

**BEST VALUE ON MARKET**



**HU448** 55-60 yds/hr., (4) 50hp mtrs.,  
(1) 30hp., turnkey on delivery



**LOG MERCHANDISER** with newly  
designed rotary stop



**SHAVINGS BIN** built in agitator,  
self-leveling auger, will unload itself



**JUMBO SHAVINGS BAGGER**  
70 cubic ft, conveyor included



**MATERIAL HANDLING  
EQUIPMENT** conveyors, decks, and  
more built to order!



**HUTTO WOOD PRODUCTS**

**803-564-7173**

**803-315-1523**

**WWW.HWP SHAVERS.COM**

**100%  
MADE  
IN THE  
USA!**



sales@hwpsavers.com  
1660 Poplar Springs Road  
Aiken, SC 29805

**FINANCING AVAILABLE**

## Complete Business For Sale in Central Kentucky

- 20 Acres Real Estate with 30' x 120' and 30' x 30' Wing  
All Concrete Pole Building, on major highway also joining a railroad track
- John Deere Powered Circle Mill, hydraulic feed, auto setworks,  
Meadows Hydraulic Edger, laser lights
- 60 Series Detroit Diesel Powered Brewco 1600 Grade Resaw with complete  
runaround, hydraulic power, transfer decks, roll cases, green chain, etc.
- Diesel Powered Precision Rosser Head Debarker, heavy duty log trough
- Diesel Powered Morbark Chip Pac, with vibrating conveyor
- 2007 L70F Volvo Articulating Loader, 8,400 hrs.
- 1997 L70C Volvo Articulating Loader, 28,000 hrs.
- 1993 L70 Volvo Articulating Loader, 12,000 hrs.

Can be seen in operation until October 15th!

**\$500,000 OBO**

Possible Financing Available

Chester M. Miller

**270-524-1003** Mill

**270-524-0725** Home

## G401 Sawmill Setworks

**2 YEAR WARRANTY**



Compare prices and features. Our G401 Setworks is the ultimate saw controller, packed with features, rugged, and built to last with non-proprietary components. Call us or visit our website for more information on our other sawmill control solutions: Edgers, Trimmers, Resaws, Scraggs, Tallies, Customized Systems and more!

**Thomas Industrial Controls**

**www.thomasic.com 1-866-899-0495**



**silverTIP** Wood-Mizer  
CARBON BANDSAW BLADES

**Profile Ground Tooth  
TIP TO TIP**

Wood-Mizer's SilverTip blade is a **TOP-PERFORMING**, economical blade for primary and secondary wood processing.

**Benchmark Knife & Saw**  
**360.577.4361**  
760 Commerce Ave.  
Longview, WA 98632

**BENCHMARK**

The Wood-Mizer quality you love. The convenience you need.



**JAMES G. MURPHY CO. NO MINIMUMS - NO RESERVES**



# 3 DAY PUBLIC AUCTION

**THE FORMER SIMPSON MILL COMPLEX IN SHELTON, WA  
9AM - OCTOBER 20, 21 & 22 - 100 N FRONT ST, SHELTON, WA**



**SHELTON MILL - ROLLING STOCK**

- WAGNER L90S LOG STACKER
- WAGNER L90F LOG STACKER
- JOHN DEERE 744H WHEEL LOADER
- CAT 904B WHEEL LOADER
- CAT 902 WHEEL LOADER
- CAT 416 BACKHOE
- BOBCAT 763 SKIDSTEER
- (10) HYSTER H210HD FORKLIFTS
- (6) HYSTER H210XL FORKLIFTS
- HYSTER H110XM FORKLIFTS
- HYSTER S80EBCS FORKLIFTS
- FORD F900 BOOM TRUCK
- (12) FORD, CHEV & DODGE PICKUPS

**SHELTON MILL EQUIPMENT**

- (2) OLYMPIC REMOTE GRAPPLE LOG LOADERS
- (2) INSERT TOOTH WHOLE LOG CUT OFF SAWS (54" & 60")
- CAMBIO SUPER 30-30" 6-RING DEBARKER
- SUMNER 8' R.H. BANDMILL W/300 HP DRIVE
- KLAMATH 30" 4-KNEE CARRIAGE W/200 HP DRIVE
- CM&E 34E SLABBER W/KEY KNIVES
- HYDRAULIC OPERATED LOG TURNER
- CAE QUAD BANDMILL W/CHIP HEADS & DOUBLE LENGTH INFEED

- CM&E 10"X42" GANG EDGER W/1400 HP
- SCHURMAN 6"X48" 3-SAW BOARD EDGER
- CM&E 4"X18" COMBO EDGER W/CHIP HEADS & USNR SCANNER
- SCHURMAN 2-SAW RESAW EDGER
- (2) IRVINGTON 22' SAWMILL TRIMMERS W/USNR SCANNERS & QUAD CAM BOARD FEEDER
- MILL TECH 24' TRIMMER W/1' SAWS
- NEWNES 16' 11-SAW TRIMMER
- 2006 FIN SCAN BOARDMASTER FSMT GRADE SCANNER
- MILL TECH 24' 50-BIN PUSH LUG SORTER
- NEWNES 12' 30-BIN J-BAR SORTER
- LSI 20' 34-BIN PUSH LUG SORTER
- MOORE 20' 32-BIN J-BAR SORTER
- (2) MILL TECH 24' STACKERS
- (2) NEWNES 20' STACKERS W/AUTOPLACERS
- NEWNES 16' STACKER W/(4) LATHE MAGAZINES
- JEFFERY 55WB HAMMER HOG
- MONTGOMERY BLO-HOG
- ACROWOOD 5416 & 6216 CHIPPERS
- (2) B.C. SCREENS - 6'X12' & 6'X8'

- (12) VIBRATORY CONVEYORS TO 94'
- (4) COMPRESSORS
- STETSON ROSS KIMWOOD 6-16-K1 PLANER
- (5) COE ALUMINUM DOUBLE TRACK DRY KILNS
- 20' & 24' TRANSVERSE SPRAY BOOTHS
- (3) BANDERS
- (2) SAMUELS AUTO PACKAGERS
- FILING & GRINDING ROOM
- ELECTRICS TO BE DETERMINED



**BID LIVE OR BID ONLINE WITH MURPHY LIVE**



**MURPHYAUCTION.COM - 1.800.426.3008**



### Crosscut Unit Saws

See in action at [www.ptmi.net](http://www.ptmi.net)

Quick, Accurate Processing  
--- Low Labor!



The Original  
Lake States "Premier"  
Industrial Hardwood  
Lumber Producer



**AJD**  
Forest  
Products



**Pallet operations have relied on us for High Quality Lumber for over 40 Years!**  
.... 1/2 "thru 8/4" pulled to length  
**Lumber, Timbers & Cants**  
If you want a good product to process in your plant and not have to deal with lots of waste...

**Call us today!**  
**989-348-5412**  
[www.ajdforestproducts.com](http://www.ajdforestproducts.com)  
[info@ajdforestproducts.com](mailto:info@ajdforestproducts.com)  
Four Mile Rd. • Grayling, MI 49738

## DON'T BE FOOLED BY IMITATIONS

Get your Genuine Woodpecker Nailing Machine Exclusively from  
**VIPER INDUSTRIAL PRODUCTS**

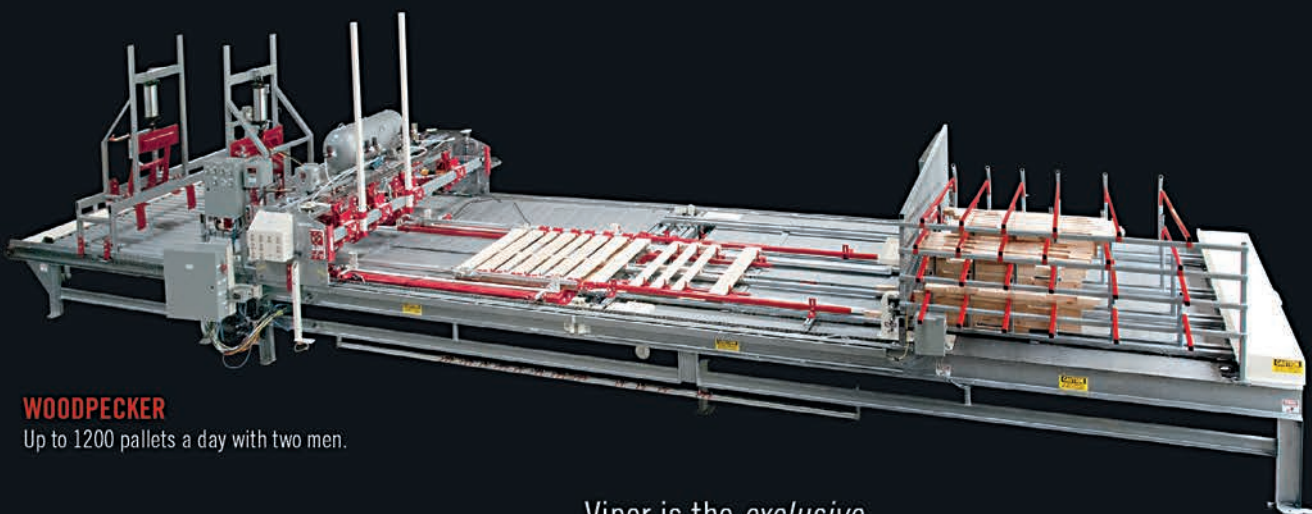

**WOODPECKER**  
Up to 1200 pallets a day with two men.

Viper is the *exclusive* distributor of Stutzman Mfg. LTD, the *ONLY* manufacturer of Woodpecker and Woodpecker Junior nailing machines.



**WOODPECKER JR.**  
Up to 500+ pallets a day with a single man.



(217) 621-2133 or (501) 679-6814  
[Viper-dwagner@alliancecable.net](mailto:Viper-dwagner@alliancecable.net)

## HUGE 2-Day LPS Annual Inventory Reduction Sale!

Thin Kerf Resaws — Baker, Brewco, Brewer, Fastline — 1 to 5 Head



**Hundreds of items will be offered at auction! Don't Miss It!**



**Toll Free: 800-598-3651**  
[associateauctioncompany.com](http://associateauctioncompany.com)

## Bevel Buddy™ makes chipping more profitable



- Reduce knife changes and resharpening costs
- Less downtime = more production time = BIGGER PROFITS
- Extended life for chipper parts such as bolts, knife holders and clamps
- Use less fuel with sharper knives

**Bevel Buddy is available at all Authorized Morbark Dealer locations. To find a dealer in your area, go to [www.morbark.com/find-a-dealer](http://www.morbark.com/find-a-dealer) or call 1.800.255.8839.**



### Not Just Carriages!

- Carriage Drives  
Hydrostatic & Electric
- Airbag & Hydraulic Cable Tensioners
- Custom Material Handling Systems
- Bar Type Log Turners  
2500 - 3500 lbs
- Sawyers Cabs & Control Cabs
- Contact Us Today For Information

[www.cleereman.com](http://www.cleereman.com) | 715-674-2700 | 5500 Pine St., Newald, WI

Lumber News Since 1922

## HARDWOOD MARKET REPORT

Memphis, TN 38088-2633  
Telephone: 901-767-9126 ~ Fax: 901-767-7534  
E-Mail: [hmr@hmr.com](mailto:hmr@hmr.com) • Website: [www.hmr.com](http://www.hmr.com)

*Contact us or go online at [hmr.com](http://hmr.com) for a sample copy.*

**The acknowledged source for hardwood pricing**



### AN 926 AUTOMATIC PLANER

**MATERIAL CAPACITIES** | Width: 0 to 26"  
Thickness: 1/4" to 12"  
Length: 10"+

Helical Cutter Head that features multiple carbide knife inserts that have 4 wear surfaces that can be rotated for longer life

Helical Cutter Head powered by a 10 HP electric motor

Convenient Control Panel allows operator to instantly change the table height and start/stop any motor

Digital readout for planing thickness

Feed speed: Fully variable 20 to 60 fpm

**BAKER Products** | 573.663.7711 | 800.548.6914 | [BakerProducts.net](http://BakerProducts.net) | [info@BakerProducts.net](mailto:info@BakerProducts.net)

## Carolina Inspection Services, Inc.

"We provide certification for WPM & HT programs under ISPM-15 guidelines."

INSPECTION SERVICES

US - CERTIFICATE SERVICES

HT DUN HT

CONSULTING SERVICES

Carolina Inspection Services, Inc. is an accredited agency with the American Lumber Standard Committee (ALSC) to provide heat treatment (HT) inspection services for both lumber and Wood Packaging Materials (WPM).

Stamping Quality on your wood products.  
[www.carolinainspection.com](http://www.carolinainspection.com)  
**866-753-5738**  
704-624-1946 (fax) Monroe, NC 28110



## Need it FAST? Need it RIGHT? Call Ozark!



### Mill Chain and Sprockets, Roller Chain and Sprockets, Speed Reducers

*Plus almost everything else to keep your mill running smoothly.  
See our complete inventory at [www.ozarkindustrial.com](http://www.ozarkindustrial.com)*



**www.ozarkindustrial.com** | [Inquiries@ozarkindustrial.com](mailto:Inquiries@ozarkindustrial.com)

**Toll Free:**  
**877-266-8202**

**Local:**  
**870-269-8788**

# Smith Sawmill Service Works Hard to Improve Quality in Your Mill... *Every Day!*

**There are no shortcuts to success.  
Just hard work and good, honest craftsmanship go into everything we produce.**



Michael Smith and our Armstrong Circle Saw Leveler make sure your saws are top notch and ready to go before leaving the shop.



Our New Vollmer CP200 Saw Grinder guarantees the highest precision and ultimate accuracy for your circle saws.

**We are an Authorized Nationwide Stocking Distributor for **SIMONDS** and *Armstrong* Parts, Equipment and Supplies.**

*Now you can make one call or send one e-mail to get whatever you need to keep your mill running...and running right!*

**Bandsaw Blades • Knives • Saws • Filing Room Equipment • And Lots More!**

Check us out at [www.smithsawmillservice.com](http://www.smithsawmillservice.com) or call **1-800-598-6344**

e-mail: [paul@smithsawmillservice.com](mailto:paul@smithsawmillservice.com)

**"SAWMILL SMART/ SAWMILL TOUGH!"**

**A-C-T® ACCURATE CHIPPING / CUTTING TECHNOLOGY**



# HUGE TWO DAY ANNUAL INVENTORY REDUCTION SALE



25995 HWY 70,  
BRUCETON, TENNESSEE 38317



## OCTOBER 16 & 17, 2015 • 9AM CST

Hundreds of Hand Selected Items will be offered at Auction. This Sale will include **EVERYTHING** a Lumberman needs! Sawmill Carriages, Drives, Headrigs, Debarkers, Gang Saws, Thin Kerf Band Resaws for Grade & Pallet Lumber, Planers, Molders, Chippers, Trimmers, Forklifts, Loaders, Trucks, Trailers, Material Handling Equipment and MUCH MUCH MORE!

Here Are a Few Examples of the **GREAT DEALS** on Quality Sawmill, Pallet, Rolling Stock & BioMass Equipment That Will Be **SOLD!**

- BREWER SINGLE HD RESAW MDL BR-SE2-1B 15HP MTR
- BREWER SINGLE HD RESAW MDL BR-1BBX12R 20HP MTR
- BREWER 10' RETURN BELT HYD DR, S/N 100793
- BREWER 5' 4 STRAND RETURN TRANSFER
- VIKING PALLET MASTER 36" RESAW W/10HP MTR W/3HP HYD UNIT
- BREWER 5 HEAD RESAW W/20HP MTRS ON EACH HEAD
- BAKER 3 HEAD BAND RESAW
- BREWER SILVER EAGLE 4 HEAD BAND RESAW MODEL BR-4B-SE 15HP MTRS, S/N 040396
- BAKER 4 HEAD BAND RESAW MODEL BBR-0, S/N 99-2788
- BAKER 2 HEAD BAND RESAW MODEL BBR-0, S/N 94-943
- (4) 3' X 4' SCISSOR LIFT TABLES
- FUTURA 2000 SHRINK WRAPPER MACHINE
- 2004 HURST BOILER JOB#0400448 MAX PSI 15 STM STEAM LBS HRS 8,625, S/N S1250-15-24 OIL FIRED
- 1983 NATIONAL BOARD WOOD FIRED BOILER S/N 53
- 1995 CLEAVER BROOKS MODEL OB1700300:15 NATURAL GAS, S/N 0L094585
- NEWMAN PLANER
- BREWER 5' 4 STRAND RETURN TRANSFER
- WOODS 133 BM MOULDER/PLANER
- BUSS MODEL 55 PLANER 14 X 30
- YATES/AMERICAN A-62 8K PLANER, S/N 26136
- YATES/AMERICAN PINEAPPLE FEED ROLLCASE
- (3) PALS TRAILER DOCKS
- PENDU 1400 CUT OFF SAW S/N 7903R03-7764A
- 3 HEAD BAND RESAW
- DEWALT RADIAL ARM CUT OFF SAW
- (9) CUT OFF SAWS UP TO 72"
- DEWALT RADIAL ARM SAW
- ROCKWELL RADIAL ARM SAW
- PENDU DBL HD NOTCHER MDL 6700P, S/N 9725-0802
- MMT SINGLE HEAD NOTCHER
- STENNER BAND RESAW W/30HP MTR 5" BAND MC SIZE 105
- PENDU CONTROL STAND
- BAKER CONTROL BOX W/AIR RESERVE TANK & FILTER
- BAKER BOARD FEEDER 1HP MODEL BT-0, S/N 98-570
- NUMEROUS STENNER BAND RESAWS
- WALLING 3 HEAD BAND RESAW
- (5) MJ3210 BAND SAWS (JAPANESE)
- 3HP TO 100HP HYDRAULIC UNITS
- SULLAIR 125HP AIR COMPRESSOR MODEL V-2000S
- SULLIVAN/PALATEK 50HP SCREW AIR COMPRESSOR 15,376 HRS.
- SULLAIR MODEL SRV-1400 SCREW AIR COMPRESSOR 50HP
- TG AIR DRYER, S/N 800154
- INGERSOLL-RAND 50HP AIR COMPRESSOR, S/N G6707U98050
- 10HP A-JAX TANK MOUNT AIR COMPRESSOR
- GARDNER-DENVER 40HP SCREW AIR COMP S/N S210816
- LEROI 60HP SCREW AIR COMPRESSOR, S/N 4154X376
- QUINCY 100HP SCREW AIR COMPRESSOR MDL Q490
- QUINCY 75HP SCREW AIR COMPRESSOR, S/N 940351
- IRON HORSE SPL TANK MOUNT AIR COMPRESSOR
- INGERSOLL-RAND 15HP TANK MOUNT AIR COMPRESSOR
- GARDNER DENVER 125HP AIR COMPRESSOR, S/N S021578
- INGERSOLL-RAND 25HP SCREW AIR COMPRESSOR, S/N PX3171404110
- CURTIS 75HP SCREW AIR COMPRESSOR MDL S75D, S/N 6877L99014
- KELLOGG AMERICAN 20HP TANK MOUNT AIR COMPRESSOR
- INGERSOLL-RAND 25HP TANK MOUNT AIR COMPRESSOR
- KELLOGG AMERICAN 25HP TANK MOUNT AIR COMPRESSOR
- APPROX. 300 GALLON RESERVE AIR TANK
- LAVAL AIR SEPARATOR MODEL PC20500
- NUMEROUS DUMPSTERS
- OVER 200 DRY KILN CARTS - MORE COMING
- UHRDEN INC DUMPER W/HYDRAULICS
- KOHLER MDL 40 DIESEL GENERATOR, JOHN DEERE 4 CY
- MAGNA ONE SYNCHRONOUS AC GENERATOR 235KW 291KVA, S/N ORD3204483
- OMNITRADE MACHINERY METAL LATHE, S/N 6-98 70 24
- HMC AC50 3 HB CARRIAGE TRACK & PANAGRAPH
- CLEEREMAN 38" 4HB CARRIAGE
- 1984 SALEM 48" 3 HB CARRIAGE, S/N 1101617
- EDMISTON 4 HB CARRIAGE
- 1982 HMC AC 40 4 HB CARRIAGE, S/N 339
- 1979 SALEM 42" 3 HB CARRIAGE, S/N 86575-79
- MORBARK 2 HB MODULAR MILL W/2 SAW VERTICAL EDGER
- CLEEREMAN MDL 40 3 HB CARRIAGE TRACK, PANAGRAPH & SAW CAB W/CONTROLS, S/N 40-697-R99
- CLEEREMAN MDL 40 4 HB CARRIAGE TRACK, PANAGRAPH & SAW CAB W/CONTROLS, S/N 40-827-R04
- MEADOWS 3 HB CARRIAGE TRACK & PANAGRAPH
- CLEEREMAN MDL 36 3 HB CARRIAGE TRACK, CAB
- CORLEY 48" SLANT 3 HB CARRIAGE TRACK, PANAGRAPH, CAB & CONTROLS
- CMC 4 HB MODULAR MILL TRACK, PANAGRAPH, CARRIAGE DRV, CAB & CONTROLS
- FRICK 1180-C 5 HB CARRIAGE TRACK HUSK FRAME COMP MILL DRV UNIT
- MEADOWS 2 HB CARRIAGE TRACK, HUSK FRAME, PANAGRAPH CAB & CONTROLS
- EDMISTON 4 HB CARRIAGE TRACK, PANAGRAPH, HUSK FRAME W/TOP SAW CAB & CONTROLS, LOG TURNER
- CLEEREMAN 3 HB CARRIAGE TRACK, HUSK FRAME
- 3 HB JAPANESE CARRIAGE & TRACK
- CLEEREMAN MDL 48 3 HB CARRIAGE W/PANAGRAPH & HUSK FRAME, S/N 48-395-92
- WOOD-MIZER LT300 THIN KERF BAND SAW MILL W/CAB
- (9) CHAIN TYPE LOG TURNERS
- PHL 62" VERTICAL RESAW MDL MCDONOUGH 62-90-ILT
- SALEM 72" HORIZONTAL RESAW
- 1995 JOCAR 62" RESAW, S/N 236
- MCDONOUGH 54" RESAW, S/N 54EC-15-44
- BREWCO MODEL RESAW W/75HP MTR, S/N BBB0598
- FORANO 7' BAND MILL
- GO-FAST BAND RESAW W/50HP MTR
- MCDONOUGH 72" RESAW, S/N 72MA-604
- 6' SALEM RH BAND MILL INSIDE BLDG
- CORLEY INFED LINE BAR ROLLCASE W/4 STRAND TRANSFER
- MULTIPLE HMC, CMC & TYRONE BERRY FEEDWORKS
- SCRAGG MILL OVERHEAD 50HP MTR
- PENDU OVERHEAD SCRAGG MILL (2) 50HP MTRS
- PENDU 6900 SCRAGG MILL W/(2) 75HP MTRS W/CAB
- FASTLINE SUPER SCRAGG BAND MILL MDL FL55
- PENDU SCRAGG MILL W/(2) 15HP MOTORS
- OVERHEAD SCRAGG MILL W/(2) 50HP MOTORS BLOWER
- JW PENNY SHORT LOG SAW W/20HP MTR MDL EHO-EP A
- SHARP CHAIN SCRAGG MILL W/20HP MTR
- NICHOLSON RING TYPE DEBARKER
- 1987 NICHOLSON 22" A-5 RING DEBARKER, S/N 5537
- MORBARK 636 DEBARKER W/CAB & CONTROLS, S/N 260
- CAMBIO 24" RING TYPE DEBARKER, S/N 79-150
- CAMBIO 18" RING TYPE DEBARKER
- FASTLINE MODEL F1DB DEBARKER, S/N 720983
- BUTT REDUCER DEBARKER, HEAVY DUTY
- 10+ TRIMMERS OF VARIOUS SIZES
- VARIOUS BLOWERS
- RADER FEEDER MODEL 20 X 25 ESW, S/N T6467
- MULTIPLE CYCLONES
- 30 + ROLLCASES 8' TO 50'
- GAP 960 NAILER
- PALLET CHIEF VIKING UNIMATIC AUTO NAILING MACHINE MDL 561-001, S/N 561-001-0987
- VIKING DUO-MATIC NAILING MACHINE MDL 508-002, S/N 508-002-0488
- GAP 960 NAILING MACHINE
- VIKING, COE, FMC & PENDU PALLET STACKERS
- KENWELL CHAMFERING MACHINE
- BREWER MDL 8124 DBL ARBOR GANG SAW W/INFED ROLLCASE & HOLD DOWN W/(2) 100 HP MTRS

Associated Auction & Liq. Co.  
PO Box 147 Clarksburg, TN 38324  
Fax: 731-986-4529

[www.associatedauctioncompany.com](http://www.associatedauctioncompany.com)  
[sales@associatedauctioncompany.com](mailto:sales@associatedauctioncompany.com)

TOMMY INGRAM AUCTIONEER TN LICENSE #3965 TN FIRM #5524



**BID LIVE ONLINE VIA**  
[WWW.PROXIBID.COM](http://WWW.PROXIBID.COM)



**Toll Free: 800-598-3651**

Join Our Mailing List! Call or E-mail  
for Complete Brochure



- FROEDGE MDL 450 DEDUSTER, S/N 171
- ALDEN GANG SAW W/50HP MTR
- (2) 2000 PINHEIRO GANG RIP SAWS
- PRECISION & INDUSTRIAL CHOP SAWS
- BREWCO 8 X 10 SPEED CUT SAW MODEL 24, S/N BB40754
- 30HP SIZER W/5HP HYDRAULIC UNIT
- BREWER SIZER W/40HP MTR
- ROGERS UNNAILER W/HYD PACK MDL 8754, S/N 0380406
- (2) INDUSTRIAL RESOURCE UNNAILERS W/HYD PACK
- (2) DIEHL SL50 STRAIGHT LINE RIP SAWS
- 24' DYNAMIC ACTION VIB. CONV. 18" BOTTOM
- 20' DYNAMIC ACTION VIB. CONV. 18" BOTTOM
- 12' PRECISION VIB. CONV. 48" WIDE W/FINE SCREEN, S/N V1.276
- 22' DYNAMIC ACTION VIB. CONV. 60" WIDE
- 22' PRECISION VIB. CONV. 18" BOTTOM
- 16' WEBSTER VIB. CONV. 22" BOTTOM
- 45' PRECISION VIB. CONV. 18" BOTTOM
- 18' DYNAMIC ACTION VIB. CONV.
- 30' DYNAMIC ACTION VIB. CONV.
- (2) NEW 10' SECTIONS OF MELLOTT VIBRATING CONVEYOR 11" BOTTOM
- 20' DYNAMIC ACTION VIB. CONV. 18" BOTTOM
- 24' CARRIER VIB. CONV. 40" BOTTOM
- VARIOUS RH & LH SAW SHARPENERS
- (4) ARMSTRONG STRETCHER ROLLS
- ARMSTRONG TRUE SIZER, S/N 18030
- ARMSTRONG #85 AUTOTIP, S/N 15123
- PAUL OPTIMIZING CUT UP SYSTEM
- (5) WEINING, WADKINS & VONNEGUT MOULDERS
- 2005 PENDU MDL 6100 SADDLE NOTCHER
- LOTS OF ELECTRICAL OF EVERY KIND
- 15 + EDGERS AND COMBO GANG SAWS
- CHIPPERS FROM 36"-66", 3K, 6K & 8K
- 10 + HOGS AND HAMMERMILLS
- WEIMA SLOW GRINDERS
- NUMEROUS SHAKER SCREENS & TROMMEL SCREEN
- COLOR CRITTER AUTO MULCH COLORING MACHINE

- MDI TWA-2000 METAL DETECTORS
- VERVILLE SINGLE & 3 BAY BAGGERS
- ROYAL 21 & 62 UNIT CHIP BINS W/HYDRAULIC
- 14 + UNSCRABLERS
- IRVINGTON MOORE TILT HOIST MTR & DR
- 1999 HOLZHER BEAM SAW, S/N VE1898 TYPE OPTIMA 4500 PINZE TAV
- 40 + DECKS FROM 5' -40', 2 TO 6 STRAND
- ROSSERHEAD DEBARKER HEAVY DUTY
- HURDLE MILL FRAME & CAB
- 52' WIDE STEP FEEDER NEW WEST IND MDL STAGE
- MULTIPLE LOG TROUGH CONVEYOR
- DRAG CHAIN CONVEYORS TOO MANY TO LIST
- 4 MATERIAL BINS W/BELT IN BOTTOM
- LUMBER CARTS & RACKS
- WASTE BINS
- BELT CONVEYORS OF ALL SIZES, 3' TO 60'
- BAKER BAND MILL MDL BBS-0, S/N 03-331 MDL PH 260
- PORTER PLANER MODEL 710, S/N 6077
- WHITNEY DOUBLE-SURFACE PLANER, 30", S/N 16052
- WHITNEY SINGLE SURFACER MODEL 32, 30"
- CUMMINS POWERED GEN SET
- FORD POWERED GEN SET W/ONAN 50° 50KW KVA 62.5
- 671 DETROIT DIESEL POWER UNIT
- 70' MODU-DECK TRUCK SCALES
- KOHLER GENERATOR MDL 150 ORZJ81, S/N #332806 - RPM 1800 - HZ 60, 4,333 HRS
- HUSKY BRUTE SERIES 125 STATIONARY KBL
- KBL STATIONARY W/HYDRAULIC PACK
- HOOD 12000 KBL STATIONARY W/ELEC MTR & HYDS
- 1994 FORD LOG TRUCK 8,729 MILES W/HUSKY BRUTE GRAPPLE
- CAT V-225B FORKLIFT DIESEL ENG W/FORK POSITIONERS - 6' FORKS, S/N 70Y00908
- CATV-15C FORKLIFT DIESEL ENG W/FORK POSITIONERS - 6' FORKS, S/N 13V01847

- CAT 9000 LB FORKLIFT MDL DPL40 - 4' FORKS, S/N 3CM12754, SIDESHIFT, DIESEL ENG
- JOHN DEER LOADER MODEL JD 644-A 3,997 HRS
- HYSTER MODEL H210XL 20,000 LB FORKLIFT, S/N D007002057N
- HYSTER MDL H190XL 20,000 LB FORKLIFT, S/N E0070022635, 51" FORKS, SIDESHIFT, DIESEL ENG
- CLARK 18,000 LB FORKLIFT, 6' FORKS, SIDESHIFT
- SELICK MDL SD-80 FORKLIFT, 4' FORKS DIESEL ENG
- HYSTER H210XL 30,000 LB FORK LIFT, 53" FORKS, SIDESHIFT, VIN #E007001715
- CAT MODEL 155 15,000 LB FORKLIFT, 46" FORKS, SIDESHIFT
- DAEWOO MODEL D30S FORKLIFT, S/N FK00330
- HYSTER H190XL FORKLIFT 20,000 LB, 55" FORKS, SIDESHIFT
- HYSTER H210HD FORKLIFT 20,000 LB, SIDESHIFT, S/N F007E01647Y, FORK POSITIONERS, 8' FORKS
- NISSAN 5000 OB FORKLIFT, 3' FORKS, SIDESHIFT, DIESEL ENG
- TOYOTA MDL 71CU FORKLIFT 5,000 LB, SIDESHIFT, 5' FORKS
- 2000 STOUGHTON 53' TRAILER MODEL AVW-535T-S-C-AR
- WABASH 53' TRAILER MODEL P-102 CW, S/N 1JJ532YORL215859
- 1995 PEERLESS 45' OPEN TOP CHIP VAN
- 2006 MAGNOLIA LOWBOY 80,000 LB, S/N 1M9L5582X71435006
- 1994 TRANSCRAFT FLATBED TRAILER SPREAD AXLE
- 42' GREAT DANE FLATBED TRAILER

**INSPECTION AND OPEN HOUSE**  
**Saturday Afternoon**  
**October 10th following the**  
**Replogle Enterprises Sale**  
**only 35 minutes away in**  
**Henry, TN.**  
**And again Mon - Thurs**  
**October 12th - 15th, Daily!**

- 1988 TRAILMOBILE 45' FLATBED TRAILER
- BWS MDL 35 HDG D LOWBOY DETACH 35 TON
- HOUGH PAYLOADER 30 W/BKT. MODEL H-30 B
- NEW HOLLAND LM640 EXTENDABOOM, S/N 737457
- JCB 5508 EXTENDABOOM LOAD ALL 8000 LB, S/N 23362
- DAEWOO SOLAR 220 LL TRACK LOADER W/GRAPPLE & THUMB
- JD 850 B DOZER 10' BLADE W/LOG GRAPPLE, NO HRS
- 671 DETROIT DIESEL POWER UNIT
- LARGE AMT. OF FLATBED & CHIP TRAILERS NOT LISTED



West Plains 400 Resaw



Morbark Stak-Trak



Several Band Headrigs



Filing Room Equipment - Band and Circular

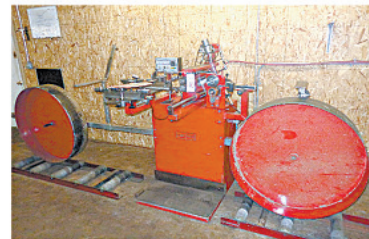

Chippers of All Sizes



Hogs and Grinders



Material Handling



Thin Kerf Resaws



Many Edgers



Chop Saws, Trimmers



Scrag Mills - Overhead, Sharp Chain, All Sizes



Rolling Stock - Forklifts, Track Hoe, Trailers



Truck Loads of Electrical

**TERMS:** Full Payment day of Auction either by cash or cashiers check. Personal or Company checks will only be accepted when accompanied with an irrevocable verifiable bank letter of guarantee with statement of limit. Full payment must be made before leaving the sale location. Equipment sold "AS IS - WHERE IS" with no expressed or implied warranties. Sale Day Announcements will take precedence over any written material. **10% Buyers premium On Site, 13% Buyer Premium Online & Phone Bidders.**

# Yader Hydraulics

Service is our Business

12317 Dover Road  
Apple Creek, OH 44606  
Phone: 330.857.0001  
Fax: 330.857.2446

---

We repair cylinders, pumps and motors



Variable Displacement Piston Pump

Replaces PVB45 on Viking Nailers and conversion kit

SAWMILL EQUIPMENT

Design & Engineering  
Powering & Plumbing

CUSTOM BUILT, DIESEL POWER HYDRAULIC UNITS



OILS & LUBRICANTS



Bulk and containers available

Parker

HOSES & FITTINGS

English and Metric  
Made While You Wait!



## MAKE THE RIGHT CHOICE!

CHOOSE...



ASSOCIATED AUCTION & Liquidation Co.

UPCOMING AUCTIONS

- ✓ October 8, 2015 (Thursday) 10 AM CT  
Knox, IN  
C & C Salvage  
*Excess Assets to the successful ongoing operations*
- ✓ October 9, 2015 (Friday) 10 AM ET  
Gouverneur, NY  
Formerly St. Lawrence Lumber Inc.  
*Sawmill Division to be offered in its entirety or piecemeal*
- ✓ October 10, 2015 10 AM CT  
Henry, TN  
Replogle Enterprises  
*Excess Assets to the successful ongoing operations*
- ✓ October 16-17, 2015 9 AM CT  
Bruceton, TN  
LPS Annual Equipment Reduction Sale
- ✓ October 24, 2015 10 AM ET  
Beaufort, NC  
Atlantic Veneer & Plywood  
*Excess Assets to the successful ongoing operations*
- ✓ November 21, 2015 10 AM CT  
Hazel Green, AL  
Formerly Priest Lumber  
*Complete Sawmill, Debarker, Rolling Stock & Buildings*

Put Our Track Record of...

- *Top Dollar for your Equipment, Real Estate & Rolling Stock*
- *Most Aggressive International Advertising Campaigns*
- *The MOST Online Bidders*
- *70 Years Combined Experience in Forest Industry Auctions & Equipment Liquidation*

To Work for YOU — Call Our Team of Professionals Now!

Associated Auction & Liq. Co.  
PO Box 147 Clarksburg, TN 38324  
800-598-3651 • Fax: 731-986-4529  
Sales@associatedauctioncompany.com  
[www.associatedauctioncompany.com](http://www.associatedauctioncompany.com)

## Sometimes Paying More just Doesn't Make Sense...



or...



Why pay for a fancy dinner to eat less food?  
Why buy a big carriage to cut 20" logs?



This custom built FR40 Carriage gets it done!

If you're spending your hard earned money on "Big and Fancy" you should take a look at the New Montgomery Carriages - - they're engineered for today's logs!



Automated Sawmill Equipment

Call for details 1-888-806-8805

Sales@MontgomeryEquipment.com [www.montgomeryequipment.com](http://www.montgomeryequipment.com)

## The One Thing... Your Circle Sawmill Shouldn't Be Without!

The New **AccraMax**™ Quick-Change Mandrel  
Drastically Reduces Downtime!

- ▶ Features removable wear plates that can be changed out in 15 minutes or less!
- ▶ Save time!
- ▶ Save money!
- ▶ Greater blade cut accuracy!
- ▶ Longer blade life!
- ▶ Faster feeding speeds!
- ▶ Higher consistency!





Plan Ahead — Cut Your Mill's Downtime. Time is Money!

AccraMax™

QUICK-CHANGE MANDREL

For more information, call  
**260-568-2534 or 260-589-2244**  
or visit [www.accramax.com](http://www.accramax.com)  
*Dealership inquiries are welcome*

**JAMES G. MURPHY CO. NO MINIMUMS - NO RESERVES**

# 2 DAY PUBLIC AUCTION

## INTERFOR TACOMA DIVISION SAWMILL

**9AM - WEDNESDAY & THURSDAY - NOVEMBER 4 & 5**

**901 EAST 11TH ST., TACOMA, WA 98421**



**SAWMILL EQUIPMENT**

**NICHOLSON A-7 27" 6-ARM RING DEBARKER**  
**MDI METAL DETECTOR 46 X 46 32" CLEARANCE**  
 WHOLE LOG METAL DETECTOR W/24" X 10'  
 NOLCO FIBERGLASS SECTION  
**PORTER OPCON SCANNER CONTROL FOR**  
 BUCKING LINE  
**TRI-TECH TWIN LOG SINGULATOR, HYDRAULIC,**  
 LEFT-RIGHT KICKERS, FLAT CHAIN FEED REX  
 DRIVE  
**(2) LINDEN 72" INSERT TOOTH SHIFTING CUT OFF**  
 SAWS, 75 HP, PORTER PLC  
**CANTER QUAD SYSTEM TO INCLUDE: (4) 6' L&B**  
 BAND MILLS, 200 HP 1180 RPM, USNR 34VEE  
 200 HP KEY KNIFE CANTER HEADS, PORTER  
 OPTIMIZATION & CONTROLS, CONTROL LOGIC,  
 USNR SST DOUBLE LENGTH INFEED, S/N: 3311-A2,  
 USNR LOG POSITIONER, SHARP CHAIN OUTFEED  
**2014 COMACT TBL-3 12" CURVE SAW GANG EDGER**  
 W/COMACT SC1-3670 SCANNER, (2) 300 HP GANG  
 CHIPPING HEADS, ARROW SPEED CONTROLS, HYD  
 FEED ROLLS, COMACT OUTFEED S/N: 10-U508-3680  
**(2) USNR 3-SAW BOARD EDGER**  
**USNR 24' TRIMMER**  
 52-BIN & 42-BIN SORTERS  
**(3) SULLAIR TS-32 300 HP ROTARY SCREW**  
 AIR COMPRESSORS  
**USNR 2000 6"X12" PLANER**  
**VERTICUT VPC-2000 PACKAGE SAW**  
**ACROWOOD 8424 6K HF RH CHIPPER**  
**VK BRUNETTE GRIZZLY 4848 HOG**



**USNR OIL HEATED DRY KILNS W/1,300,000**  
 BOARD FEET CAPACITY  
**P&H 35 TON PORTAL CRANE FOR LOG YARD**  
**(5) P&H UNDER RAILTRAVELING BRIDGE CRANES**  
 CHIP BINS  
 STORES  
 AND MUCH MUCH MORE!

**ROLLING STOCK**  
 WAGNER LOG LOADERS  
 CAT 325L HEEL BOOM LOG LOADER  
 (9) HYSTER FORKLIFTS  
 TOYOTA 02-6FDU40 8,250 LB FORKLIFT  
 (2) KALMAR DCE FORKLIFTS  
 (2) TAYLOR FORKLIFTS  
 GROVE AMZ39NE MANLIFT

## SAWMILL, PLANER MILL, DRY KILNS & ROLLING STOCK



**MURPHYAUCTION.COM - 1.800.426.3008**



# Newly Designed Crane Mat Drill

See it run at  
[www.dm-steel.com](http://www.dm-steel.com)!



**FAST** - Two employees can easily build 30+ mats per shift!

**EFFICIENT** - Drills and counter bores in one pass

**ECONOMICAL** - Call us now for your low price!

The must-have low cost, low maintenance hydraulic powered tool for building mats.

**Call 618-231-1595 or 618-927-4974**

**D & M Steel**

e-mail: [craft2nc@frontiernet.net](mailto:craft2nc@frontiernet.net)

## GOOD USED EQUIPMENT

- (2) GO FAST Dedusters
- KENT Single Head Notcher
- 2 Head End Trim Saw 60" Capacity

Call Today! **920-986-1145**

## FOR SALE

Stacker, Pendu Model 440 HD	#1515
Auxiliary Hydraulic Power Unit, Model 1030	#1525
West Plains 4 Strand 2080 Chain Deck	#1406
West Plains Rollcase	#1398 #1405
Skate Roll Deck, 20' long 2-strand w/ stops	#1494
Rollcase 15' long x 14" wide w/pillow block bearings	#1504
Pendu Model 1600 3 Strand Green Chain	#1027
Pendu Green Chain	#1270
Lumber Transfer Deck, 26' long 2-strand C55B rooftop chain	#1498
Lumber transfer deck, 19' long 2-strand C55B rooftop chain	#1495
Lumber Hoist / De-stacker, 4,000 lb capacity	#1499
10' long, 5" wide driven Roll-case w/ 2 driven top pinch rolls, air actuated	#1496
78 Chain Deck, 3-strand 10' long w/hyd. drive	#1502

For complete details call

**800-233-0471**

Email: [info@pendu.com](mailto:info@pendu.com)

**[www.pendu.com](http://www.pendu.com)**

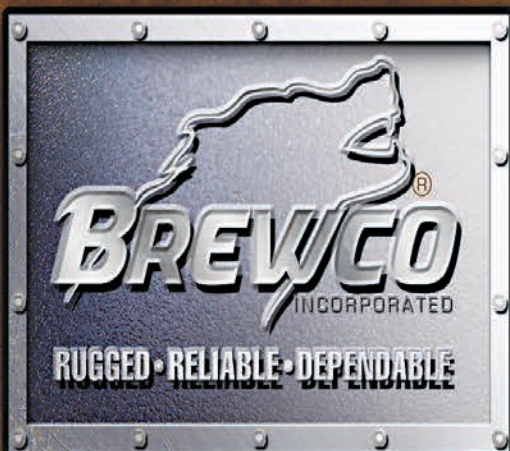

**800-237-6880**

**[www.brewcoinc.com](http://www.brewcoinc.com)**

# NEW B-1600 IN STOCK READY FOR DELIVERY

# CALL NOW!



# HOT ON THE MARKET!

## Scissor Lifts



Universal Machinery Sales and Mona Tracy have introduced a new line of Scissor Lifts for the lumber and pallet industries. These lifts range from 2,000 to 8,000 lbs. depending on your specifications and vary in height from 39" to 51". Handling of material is easier and more convenient than ever. Solid, well-built and easy to maintain and operate, this line of scissor lifts is a must-have for your operation!

For more information, contact:  
**Universal Machinery Sales, Inc.**  
 1-855-298-8890 (Toll Free) or 812-298-8090  
[www.universalmachinerysales.net](http://www.universalmachinerysales.net)  
 e-mail: [sales.universalmachinerysales@gmail.com](mailto:sales.universalmachinerysales@gmail.com)

## MaxFlex Sawmill Blades



Wood-Mizer LLC, the only sawmill manufacturer to also produce blades, introduces the durable, high performance MaxFlex sawmill blade. Manufactured with premium quality steel selected by Wood-Mizer, the new MaxFlex blade will complement Wood-Mizer's extensive line of bandsaw blades. Featuring specialized alloy to provide longer blade flex life and increased durability, MaxFlex is a tough all-purpose blade engineered for maximum sawing performance. All MaxFlex blades feature a 10° hook angle with 7/8" tooth spacing and are available in these profiles: .042 x 1 1/4", .045 x 1 1/4", .045 x 1 1/2" and .055 x 1 1/2".

"Wood-Mizer continues to focus on providing the industry with a variety of blade options for any sawing application and budget," said Wood-Mizer Blades Manager John Storm. "MaxFlex Blades give sawmill owners a premium quality all-purpose blade at an exceptional price."

With the addition of MaxFlex, Wood-Mizer now offers blades in 5 distinct brands to meet every type of wood cutting application from green softwoods to abrasive and exotic hardwoods: **SilverTip, Carbon; DoubleHard, High-Alloy; MaxFlex, Premium; Bi-Metal, Industrial; RazorTip, Stellite® and RazorTip, Carbide.**

For more information, call 800.522.5760 or visit [www.woodmizer.com/blades](http://www.woodmizer.com/blades).

## Selling at Auction

Boss, MO - November 7<sup>th</sup>



2010 Kenworth

See ad in this issue or call 1-800-334-4395 or visit [www.tristate-auction.com](http://www.tristate-auction.com) for more info.

**See For Yourself...** **TIMBER WOLF**  
 Band Mill Blades

A New Way to Buy your Blades at

[timberwolfbandmillblades.com](http://timberwolfbandmillblades.com)



## 50 YEARS OF METAL DETECTION EXPERIENCE

### SAVE ON COSTLY REPAIRS AND DOWNTIME!

You can't afford to have less than the best metal detector protection for your valuable equipment.

TWA-2000-HD



Fiberglass Sections



XR-3000 Series

MP-2000 Series

Phone: 541 345 7454  
 Fax: 541 345 7971  
[www.mdiblue.com](http://www.mdiblue.com)

**Metal Detectors, Inc.**  
*Proudly made in the USA!*

# RETOOL REPOSITION RELAUNCH



**1-1/2" RADIUS NOTCHING HEAD**



**1/2" RADIUS INDEXABLE NOTCHING HEAD**



**HIGH SPEED BRAZED SURFACING HEADS**

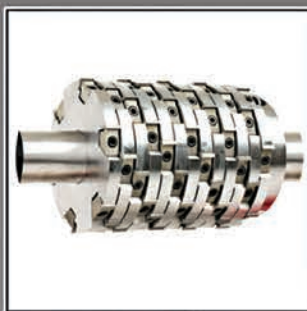

**INDEXABLE/ SIZER PLANER HEAD**



**FENCE POST PROFILE BRAZED HEAD**



**CORNER ROUNDER INSERT HEAD**



**INSERT CHAMFER CUTTERS**



**INDEXABLE INSERTS & SAW TIPS**



**EDGER/CHIPPER BRAZED HEAD**

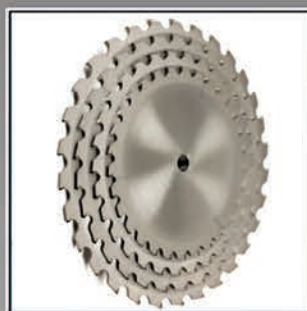

**NAILBUSTER SAW BLADES**

**GENERAL PURPOSE WOOD CUTTING SAW BLADES**

- STROB SAWS
- CROSS CUT
- RIP SAWS
- CUSTOM

**CUTTING WOOD WITH NAILS**  
CUTTER HEADS • SAW BLADES  
INDEXABLE INSERTS  
20 YEARS EXPERIENCE



John Lieber, President



CUSTOM ENGINEERED TOOLING

## PROFILE TECHNOLOGY INC.

9116 Rott Rd.  
St. Louis, MO 63127

TEL 314-965-9111  
FAX 314-966-5550

info@profiletech.com  
www.profiletech.com

North America

**800-369-4242** Since 1970



David Lieber, Sales Engineer

**New Inserted Tooth for Cutoff Saws**

**B-ITCO**

- Slasher Saw Operations
- Log Merchandising
- Firewood Processing

Bartlett's Saw Service & Supply  
**800-566-0319**

**See Our New Equipment Website**  
[www.kittrellsawmillbrokers.com](http://www.kittrellsawmillbrokers.com)

Request Our Award-Winning Newsletter with Equipment listings, Wanted Equipment, Appraisal information...and much more

Join our network and get your copy today!

Call us today **(931) 797-6284 TO GAIN ACCESS**

## Used Machinery Call Mona Tracy Today

- 1- Pallet Shop, Ohio, NY, Iowa
- 1- Stake Machine - Pencil Point
- 1- 2 Head Trim Saw
- 1- Air Compressor - Phase Converter
- 2- Morgan Portable Scraggs
- 1- Smart Band Saw/Trim Saw
- 4- Nailing Jigs/Tables, Revo
- 1- 3 Head Trio
- Disassembler-Unstubber
- 1- Hand Held Brander
- 1- 12" Wide Resaw
- 1- T-Tek Sort System
- 1- Brewer D. A. Gang, Planer
- 2- Cant Sizers, Edgers
- 1- Band Saw Disassembler - Gas
- 1- Pallet Chief II
- 1- KM-16 4 Head
- 1- Single Notcher
- 1- Chamfer
- Blowers, Phase Converter-40 HP
- 1- Yield Pro - Sizer/Height
- 2- Solo, Pass I, Disassemblers
- 1- Tipper
- 1- Stacker 60 x 60
- 1- Baker Double Notcher
- 1- Pallet Sizer - Resize Pallets
- 1- Whole Pallet Notcher
- 1- Military Band Notcher -2 Head
- 1- Rayco Edge
- 2- Rayco Pro
- 1- 4 Head Brewer w/Deduster
- 2- Doig Nailers
- 1- Gap Nailer
- 1- Brewco 5 Head Resaw

*List your used equipment with us!*

**UNIVERSAL MACHINERY SALES, INC.**

Toll Free **1-855-298-8890**  
or **812-298-8090**  
E-Mail: [info@universalmachinerysales.net](mailto:info@universalmachinerysales.net)

## The Best Fitting Sorter Parts For Sawmills!

Need faster service and lower prices for sorter & other parts for your mill? We can help!



"Send us one of your old parts, we'll build you a better one!"

- Next day shipment on sorter parts
- Wear strips cut to spec
- UHMW Channel
- FREE samples

Also: J-bars, C-hooks, pusher lugs, diverters, chain lug rollers, UHMW sprockets, plus lots more!

**Brooklet Plastics, Inc.**  
**800-842-5258**  
e-mail: [bplastic@frontiernet.net](mailto:bplastic@frontiernet.net)

# EVERYTHING YOU NEED FOR YOUR PALLET OR SAWMILL LINE

## PALLET EQUIPMENT



CUT OFF SAWS

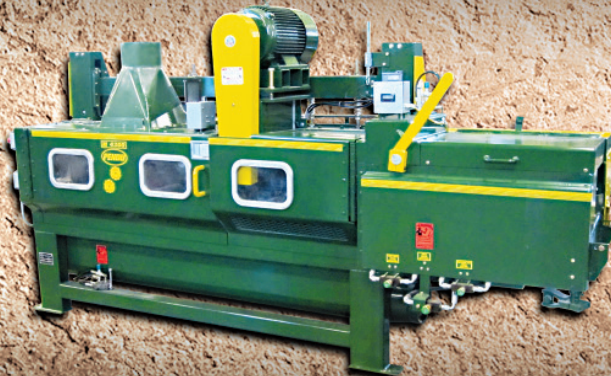

GANG SAWS

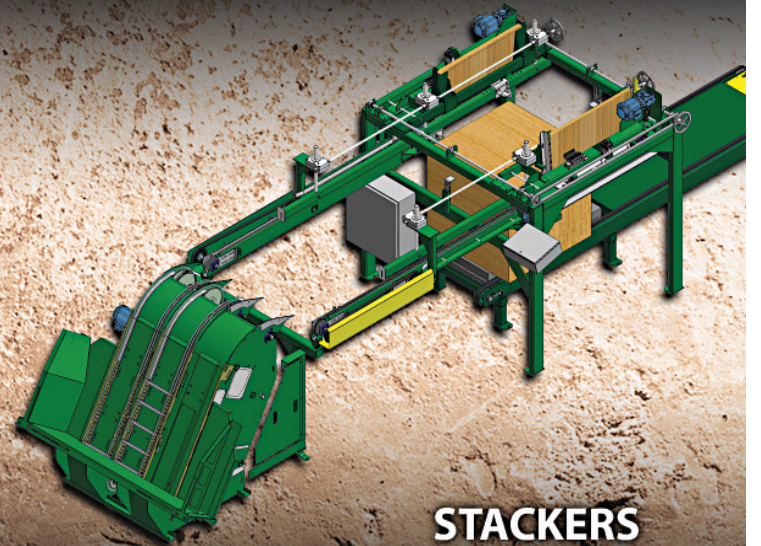

STACKERS

## SAWMILL EQUIPMENT



2 SAW TRIMMERS



MULTI-HEAD TRIM SAWS



EDGERS



**PENDU ALSO BUILDS SEVERAL MODELS OF SCRAGG MILLS, NOTCHERS, BAND SAWS, BLOWERS, & MORE! CALL OR VISIT OUR WEBSITE FOR MORE INFO!**

Stackers Trim Saws Gang Saws Scragg Mills Edgers Custom Equipment  
**800.233.0471 717.354.4348 www.Pendu.com**

# Pallet Assembly Solutions from Mona Tracy...

## Thinking About Buying A Nailing System? Universal Gives You Choices...

**Block Pallet Attachment Available!**

**The "NAIL EASE"**



*Nailing pallets has never been easier!*

- Assembles all size pallets (up to 50" x 50") with easy adjustments
- For New & Recycled lumber

**The "REVO" Revolving Work Station**

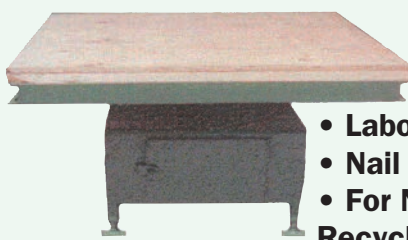

- Labor Saving!
- Nail at your own pace
- For New Pallets, Recycling or Reman jobs

**STACK-MATE Automatic Stacker**

- Adjustable capacity
- Stacks up to 20 pallets high



**Fast, Easy Assembly of Any Size Pallets!**



**NAIL-MATE Automatic Nailing Jig**

- Auto firing, one-man operation
- Handles 3 or 4-stringer pallets, wing pallets or others up to 56" x 50" at a rate of 1-2 pallets per minute!

**The Nailing Station**



- Hold down system and swivel turn over for nailing both sides
- Simple Construction of large, heavy & hard-to-handle sizes (any length possible)

**JAM DOCTOR**

- Clears Nail Jams!



# The MORGAN Line-Up!



**Original Single Head Resaw with Return**

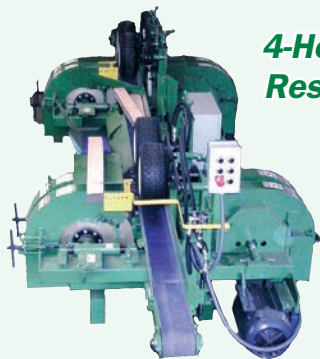

**4-Head Resaw**



**Wide Cut Resaw**



**Military Band Notcher**



**Multi-Head Trim Saw**

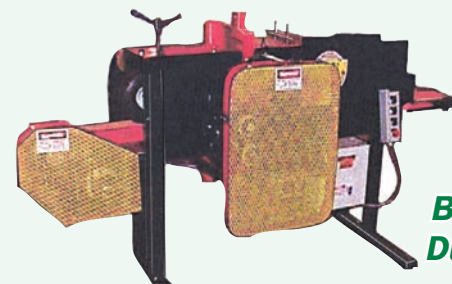

**Board Duster**



**UNIVERSAL**  
MACHINERY SALES, INC.

**Sales: Mona Tracy**  
Universal Machinery Sales, Inc.  
**Toll Free 1-855-298-8890**

e-mail: [sales.universalmachinerysales@gmail.com](mailto:sales.universalmachinerysales@gmail.com)  
[www.universalmachinerysales.net](http://www.universalmachinerysales.net)

**Parts/Service:**  
Sawmill Supplies & Equip. LLC  
**318-994-2116**

e-mail: [sawmillsupplies@centurylink.net](mailto:sawmillsupplies@centurylink.net)  
[www.sawmillsupplies.net](http://www.sawmillsupplies.net)

**Service:**  
Gary Morgan  
**318-469-5077**  
**(24 hrs.)**

**Leasing & Financing Available**