



www.amlumber.com
January 2016

American Lumber & Pallet

Sawmills • Pallet Mills • Woodworking • Logging 1-800-992-3432

Loaded with Pages and Pages of New & Used Equipment and More!

In This Issue:

Auctions

Yoder & Frey

Heavy Equipment Auctions:
February 8-15th • Kissimmee, FL
Page 50

Andy Raber Auctions LLC:

January 15th • Mifflintown, PA
Page 51

James G. Murphy Co.:

February 16th • Shelton, WA
Page 52

Shows

Expo Richmond 2016:

May 13-14th • Richmond, VA
Page 34

Northeastern Forest Products Equipment Expo:

May 6-7th • Essex Junction, VT
Page 46

I.H.L.A. Convention & Expo:

February 2-4th • Indianapolis, IN
Page 49

HAPPY NEW YEAR

2016



The proof is in the product

The Rotochopper FP-66 takes high-volume wood recycling to a new level, outperforming bigger grinders while minimizing fuel costs and maintenance downtime. Best of all, the FP-66 offers the same precision grinding built into every Rotochopper, so you get better mulch, fuel, or bedding, at a lower cost per ton or cubic yard.

How can the FP-66 maximize the value of your wood waste? Contact us to learn more.

320-548-3586 www.rotochopper.com

Follow Rotochopper on      

PRESORTED
STANDARD
U.S. Postage Paid
Atlanta, GA
Permit No. 3592

AMERICAN LUMBER & PALLET
P.O. BOX 1136
FAYETTEVILLE, TN 37334



Profile Ground Tooth
TIP TO TIP

Wood-Mizer's SilverTip blade is a **TOP-PERFORMING**, economical blade for primary and secondary wood processing.

Smith Sawmill Service

800.598.6344

181 Co Rd 4763
Timpson, TX 75975

The Wood-Mizer quality you love. The convenience you need.

TO MAKE EVERY DOLLAR COUNT— YOU HAVE TO MAKE EVERY CUT COUNT



Selecut® V with **Inline Squeeze**

- For prime lumber cut to length or Precision End Trimming needs, our Selecut®-V uses a Fixed Frame Assembly with a moveable cutting platform to meet your production needs in a limited space environment and is available with our Inline Power-Squeeze Package Alignment system.
- For high-volume automated crosscutting of industrial length stock, our Autocut®-V uses a computerized carriage assembly with PLC controls enabling you to process lumber without an operator present.

Transcut® II Station

from **\$26,999***

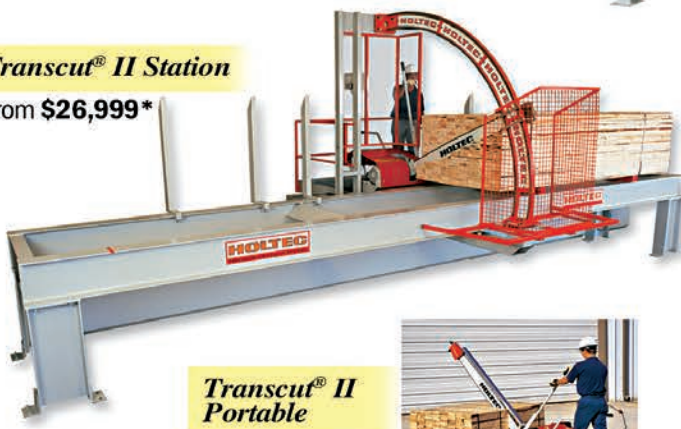

Transcut® II Portable

from **\$7,999***



Autocut® V

- For custom manufacturers, our Transcut® II Station will cleanly cut through a unit of hardwood or softwood in less than a minute using generic chain-saw chain and with a precision of +/- 1/16th" or better*.
- For simple crosscutting of EWP or lumber, our versatile Transcut® Portable saws are priced and designed to offer a significantly safer and faster alternative to hand-held chain saws.

We're proud of the fact that HOLTEC pioneered the concept of precise package cutting over 40 years ago. Today our industry's technological and manufacturing advances have enabled us to achieve the fastest cut in the industry and an unmatched precision on every cut. So, if you're considering investing in a package-crosscut saw, consider these facts*:

- At 55 seconds per cut HOLTEC systems cut up to twice as fast as other systems available today;
- With our own team of dedicated Field Technicians and service vehicles, HOLTEC is the only company that provides you a service response time of 24 hours or less on-site and on-time;
- Our state of the art Germany manufacturing facilities are ISO-9001 certified, ensuring that you're getting the highest quality manufacturing standards available today;
- With an unmatched precision of +/- 1mm (.040"), HOLTEC systems exceed precision-end-trim tolerances;
- HOLTEC systems are designed with the highest safety standards in the world, ensuring that your employees are working in the safest environment for package-crosscutting available today;
- HOLTEC has almost 2,000 systems in North America and over 8,000 systems delivered worldwide, ensuring that we'll be here for you in the future as we have been for the last 40 years

WE ENSURE EVERY DOLLAR COUNTS BY ENSURING EVERY CUT COUNTS

HOLTEC®
PRECISION CROSSCUT SYSTEMS

www.holtecusa.com

Holtec [USA] Corporation, 2802 Sydney Road, Plant City, Florida 33566 • [813] 754-1665 • Fax [813] 752-8042

TOLL FREE 1-800-346-5832 • eMail: info@holtecusa.com

*All specifications are subject to change without notice. Pricing is FOB Tampa, Florida and subject to change without notice. Photographs may show systems with optional accessories. On-site service may not be available in certain remote locations. Proper maintenance procedures are essential for accuracy and longevity, and accuracy results are based on HOLTEC installed systems using Scratcher® chain technology. Stroke speed may vary based on specie and dimension of lumber. HOLTEC, TRANSCUT, SELEcut, AUTOCUT & MAXIMUS are registered trademarks of HOLTEC GmbH. All other trademarks are the property of their respective owners. Warranty and guarantee terms are subject to limitations and delivery or installation to certain remote locations may incur additional charges. ©2015 HOLTEC (U.S.A.) Corporation

Ask About Our Freight Assistance Program!

We Have the Industry's **BEST** Reputation for Used Sawmill and Planing Mill Equipment!



Armstrong No. 2 Sharpener



Kockums 6x6 Chip Screen



Mill Power Vibrating Conveyor



Soderhamn 7x7 Chip Screen



USNR 32-Knife Planer Line



Ripjack Pallet Plater



Morbark 640 Debarker



6-Arm Tilt Hoist



Smithway XL Ripsaw



Log-To-Sawdust Grinder



Rebuilt 6 ft. Salem Air Strain Bandmill

This is only a small selection from our HUGE inventory.

Visit our website –

www.machinerysales.com

– or call us for help with your next project.



McDonough 54 in. Resaw



Simonds Bandsaw Leveler



Precision 66 in. Chipper



Banding Notcher



Precision 58 in. Chipper



20-Unit Peerless Bin

Over 10 Acres of Machinery In Stock!

Call (Toll Free) **1-866-241-2977**

For a complete equipment listing, go to

www.machinerysales.com

e-mail: machsales@msn.com

info@machinerysales.com



503-285-6691

Fax 503-285-0449

9802 North Vancouver Way

Portland, OR 97217

Visit our YouTube channel at www.youtube.com/user/machinerysales1

Process Logs, Boards, Cants or Lumber Packages... L-M Equipment Has A Machine To Fit Your Operation!



L-M Equipment has been manufacturing quality products for the lumber industry for over 60 years. We offer supervised installation, start up assistance and operator training for all our equipment. We also have service technicians ready to respond to any situation, offering solutions to customers' problems around the world.

Verticut P4 with Inline Squeeze Perfect for Rig Mat & Truss Stock

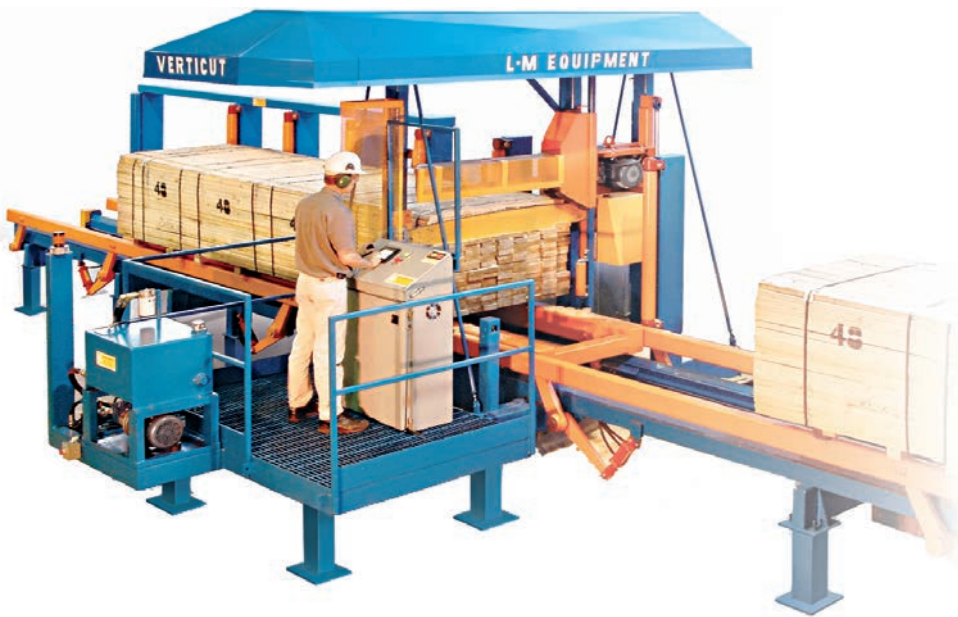

The I-CUT

Learn more about L-M Equipment on

Search: **LM Corporate Video** 

Precision. Performance. Production. Profit.



L-M Equipment Company Ltd.

604-576-0088 • Fax 604-576-0089

Toll Free 1-800-455-8807

Email: sales@LMSaws.com

www.LMSaws.com

Are You Ready for the Latest Market Changes?

Hurdle Sawmills are *EASY* to INSTALL, OPERATE & MAINTAIN

- Proven in over 450 installations!
- Simple design with over 40 years of refinements and improvements
- A Hurdle mill followed by a resaw is an efficient, low cost, low maintenance replacement for an expensive grade bandmill installation
- For crosstie and pallet mills, our 2HB mill sets the standard for production
- Complete with 36" or 40" Challenger carriage, log deck, bar or chain log turner, offbearer belt, sawyer's cab, carriage drive, and setworks
- Optional Hurdle Vertical Edger eliminates expensive edgerman and downstream edger equipment
- Optional computer setworks, cant turners, hammer dog, top-saw, and more
- **Go to www.youtube.com/HurdleMachineWorks to see it in action!**

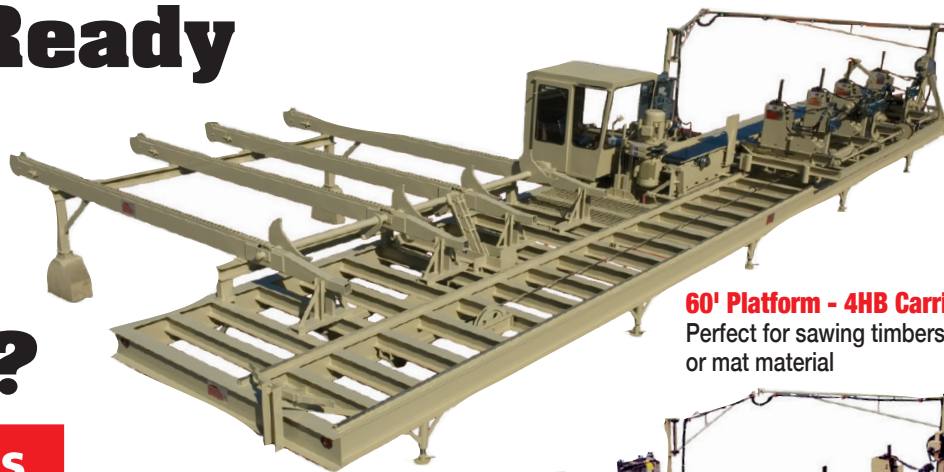

60' Platform - 4HB Carriage
Perfect for sawing timbers or mat material

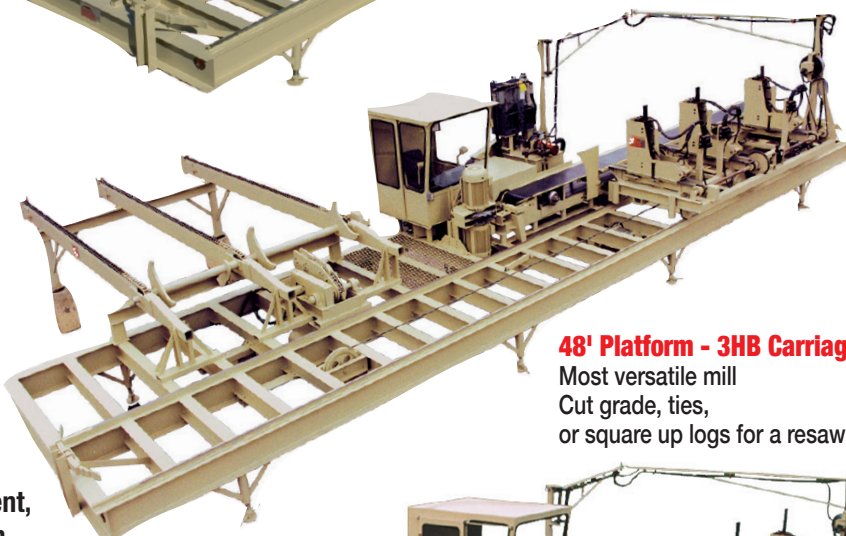

48' Platform - 3HB Carriage
Most versatile mill
Cut grade, ties, or square up logs for a resaw



40' Platform - 2HB Carriage
The standard for crosstie mills

A Hurdle Complete Mill Package will fit *ANY* size operation!



16195 Hwy. 57 Moscow, TN 38057
(901) 877-6251
www.hurdlemachineworks.com

CORINTH PARTS
We are the source for any and all models of Corinth Sawmill parts. We also stock all your sawmill supply needs: **SIMONDS** saws, sawbits, shanks and knives, Tyrone Berry carriage feeds and parts, Parker Hannifin cylinders, valves and parts, and more.

NEED FAST SERVICE? YOU GOT IT!

Corinth Mill Supply
318 Tate St. P.O. Box 574
Corinth, Mississippi 38834
800-356-3893
(MS) 800-843-8930

WV MINE TOOLS & SERVICE, INC.
Try Our Popular SABER INSERTED CARBIDE SAW BIT.
Only \$2.45 per bit!

WE ARE AT THE CUTTING EDGE OF YOUR BUSINESS!

FREE SAMPLES!

- ▶ Dressing Sticks for wheels... \$6.00 ea.
- ▶ \$75.00 for 4 inch Diamond Jockey Wheels

Call TOLL FREE 888-291-5956

WV MINE TOOLS & SERVICE, INC.
PO Box 402, MT. Morris PA 15349
weaver399@msn.com



American Lumber & Pallet
Sawmills, Pallet Mills, Woodworking, Logging

Published Monthly By:
ASKINS PUBLISHING GROUP, INC.
P.O. Box 1136
Fayetteville, TN 37334

PUBLISHER/EDITOR
Bill Askins
bill@amlumber.com

ADVERTISING SALES
Shawn Askins
shawn@amlumber.com
1-800-727-9684

Randy Tallman
randy@amlumber.com
1-800-992-3432

CIRCULATION DEPT.
circulation@amlumber.com

GRAPHIC DESIGN DEPT.
Jeff Moyers
jeff@amlumber.com

Barbara Locker
bop@amlumber.com

PHONE: (931) 433-1010
TOLL FREE: 800-992-3432
Anywhere in the U.S.A. & Canada

FAX: 931-433-1081
E-MAIL alp@amlumber.com
www.amlumber.com

Subscriptions (Presorted Standard Mail)
Free to Sawmills, Pallet Operations, Woodworkers, Veneer & Chip Mills and Loggers with portable sawmills in the U.S. Other businesses or individuals in the U.S. \$25.00 per year.

Subscriptions (First Class Mail)
U.S.A and CANADA - \$50.00 per year.
Other foreign subscriptions call for prices.



Any advertising copy submitted for publication is deemed the property of the advertiser, and is used on the condition that all liability for copyright laws is the sole responsibility of the advertiser.

USED EQUIPMENT FOR SALE

- ◆ Precision Chip Screen Model- PCS55
- ◆ Kiwi Printer Model- 1020
- ◆ Ritter Belt Sander Model- R-700
- ◆ Tepco Media Air Cleaner Model- M26V
- ◆ Safety Speed Cut Panel Saw Model- H5

270-753-3261
E-mail: paintpaddles@att.net

Pallet Lumber For Sale
4/4 Green Hardwood
Trailer Loads Regularly Available
Red Oak & Other Species
Fixed widths of 4" and 6" or RW
Lengths of 4-8 or 9-12 feet
Also 5/4 Hickory all 4" 4-8' or 9-12'
Contact Jon St. Jean
(860) 974-0127 x14
stjean@hullforest.com



FOR SALE

- 74 HP Allis Chalmers Diesel Engine w/Turbo Charger, No Clutch
- Miner Edger, 4 Blade w/6" Opening - Works Good!
- All Hydraulics for Meadows Mill w/Log Turner

Call Joe **620-224-7651**

The Future of Pallet Assembly is Here



Mach 2 Flexible Line

- A modular machine that grows with your business and can be easily adapted to produce stringer and block pallets
- Produces 2,500 stringer pallets per 8 hour shift with just 3 operators
- Reduces labor costs and downtime, while increasing production
- Optional board feeders and robotics can reduce required operators

CONTACT US TODAY TO FIND OUT HOW WE CAN ADVANCE YOUR BUSINESS THROUGH AUTOMATION



844-886-3811
PRSGroupInc.com

TOMORROW'S TECHNOLOGY, TODAY

**Automated Pallet Assembly - Stackers - Conveyors - Dismantlers
Trim Saws - Band Saws - Splicers - Platers - More**

ARMORHOG® Extreme Duty Grinder Parts

ARMORHOG® uses NITROGRIT™ A proprietary blend of carbide found to best suit grinding applications.

ARMORHOG® is totally focused on providing top quality, Extreme Duty replacement parts for all brands & models of industrial grinders, specializing in rigid hammer grinding applications.

Arm Your Hog With ARMORHOG!
Extreme duty aftermarket grinder parts for all grinders.

www.armorhog.com
800.743.3491 • sales@armorhog.com

BATTLE READY • WEAR RESISTANT • BEST VALUE



Third Man Nailer

Build Pallets Faster and For Less Money!

RT Pallet Equipment
306-737-3310
email: roberttrembley@hotmail.com
www.rtpalletequip.com

View the video on our website.
BOX 29 Imperial SK
S0G 2J0 Canada

Call for FREE DVD
Jig & Stacker



Simonds Saws Are The Best!

For over 180 years Simonds has thrived in the saw business by manufacturing the best saws in the industry.

Simonds Trademark Series Inserted Tooth Saws are produced using Nickel Alloy plate that is processed in our new heat treat facility. Our new on-site heat treatment is producing plates with a consistent hardness and uniform flatness that is not available from 3rd party plate suppliers. Simonds' saws keep maintenance costs down, maximize saw run time and add profit to your bottom line.

The Trademark Series Saw features:

- Finest Quality Nickel Alloy plate manufactured in Big Rapids, MI.
- Precision Laser Cutting and CNC milling
- Computer-controlled spin tester checks for vibration and run out

We have the most experience in the business manufacturing saws. We make the best — And now they just got better!

Simonds new saw plate heat treat facility enables us to deliver the flattest and toughest saws in the business!



800-426-6226 | sales@simondsint.com | www.simondsinternational.com

The Professionals' Edge™

Scan this QR code for additional information on our website.



Make More Money From Your Waste! Alternative Energy Is The Way To Go Today!

Don't Miss The Opportunity To Expand Your Business With A New Line of Pellet Mills and Complete Pelletizing Systems from Crown Machinery.

As one of the largest growing sources of alternative energy in the world, pellet mill facilities are popping up all over the globe; and they are continuing to grow in numbers.

We can help you join this growing market or help you to expand on your current operations.

Why Pay More? Buy Direct From Crown and SAVE 25% or More!



Maximum Efficiency and Productivity • Handles all types of material found in bio-fuel & feed markets • Warranty and turn-key service from Crown



Our new line of Hammer Mills are available in various sizes and range in capacity from 500 lbs./hour up to 6 tons/hour. **These mills are High Capacity, Extremely Durable and Long Lasting.**

Compare them to other Hammer Mills on the Market. Crown Hammer Mills cost a fraction of the others!



CROWN MACHINERY

SCOTTSBORO, AL

256-218-3045

Fax: 256-218-3062

Sales, Service, Engineering, Installation & Removal of Equipment

www.CrownMachinery.us

harvey@crownmachinery.us

PAWTAWJOHN SERVICES, INC.
(208) 687-1478 / www.pawtaw.com

MTS Factory Authorized MTS Temposonics™ Distributor and Warranty Repair Center
Cleereman carriage systems provider

FIRST-CLASS EQUIPMENT & DEPENDABILITY
AND EXCELLENT SERVICE AVAILABLE 24/7

Do you have internet access in your mill?
Ask us about our machine monitoring capabilities.

Check out our Trimmer Saw System
User Friendly. Easy Setup. Efficient. Affordable.

7 SAW TRIMMER CONTROL SYSTEM

ClearSpan fabric structures
1.866.643.1010 ClearSpan.com/ADALP

WE MANUFACTURE - WE INSTALL
WE SAVE YOU MONEY
WAREHOUSING SOLUTIONS FOR ANY INDUSTRY

Fabric Structures
Natural Light & Low Cost Per Sq Ft

Hybrid Buildings
Benefits of Metal & Fabric Buildings

Foundation Solutions
Build Anywhere & Quick Construction

GET 0% FINANCING FOR 84 MONTHS OR GET A BIG CASH DISCOUNT* RESTRICTIONS APPLY

Jump Start Your Production With An A.I.T. HY 400 High-Speed Center Splitting Resaw

- Speeds up to 400 feet per minute
- Great for both center splitting and line bar cutting
- 50 HP Motors Power 2 12" .125 Kerf Saw Blades

Increase Production and Reduce Labor With An M2L High-Speed Automatic Board Stacker

- Installs behind your resaw, notcher or chamfer
- Improve operator safety and save big on labor costs!
- Auto Tie strip option available • A Real Workhorse!

We're Ready To Help You Improve Your Bottom Line...

PALLET MACHINERY GROUP
6496 Landing Road / King George, VA 22485
Phone: 540-644-9220 / Fax: 540-663-4081
info@palletmachinery.com / palletmachinery.com

EVERYTHING YOU NEED FOR YOUR PALLET OR SAWMILL LINE

PALLET EQUIPMENT



CUT OFF SAWS

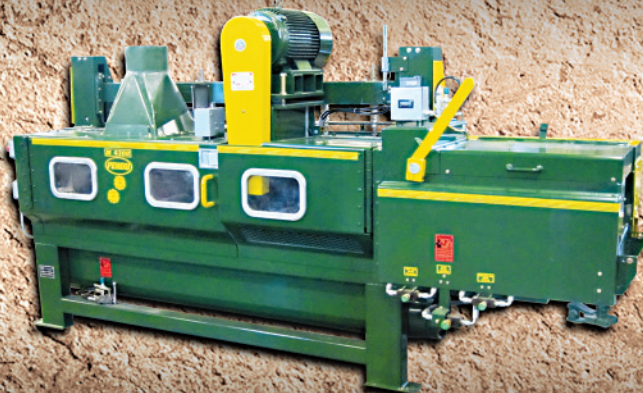

GANG SAWS

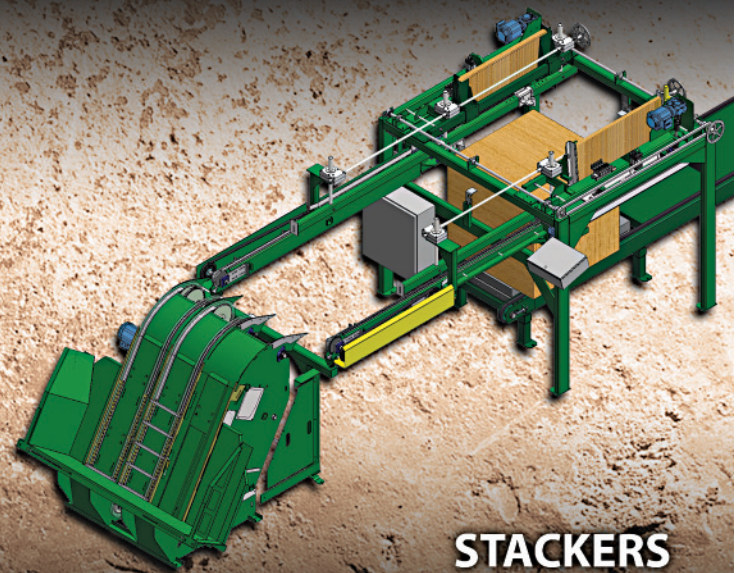

STACKERS

SAWMILL EQUIPMENT



2 SAW TRIMMERS



MULTI-HEAD TRIM SAWS



EDGERS



COME SEE US AT THE SHOWS!

IHLA EXPO: Feb. 2-4 Booth #112

NWPCA ALC: March 2-4 Booth #214

Stackers Trim Saws Gang Saws Scragg Mills Edgers Custom Equipment

800.233.0471 717.354.4348 www.Pendu.com

The NEW 40-C From Built-Rite

THE ***ONLY*** PROCESSOR EVER BUILT WITH AN OPTIONAL HYDRAULICALLY OPERATED SLIDING SPLITTER BEAM, ALLOWING YOU TO SPLIT FROM 12" — 32" LENGTH



- 83 HP Turbo Charged Kubota
- 48" Carbide Insert Circular Saw
- Vertical Saw Motion - reduces rocking and frame stress
- Powered Hourglass Infeed Rolls
- Triple Multi-Wedge with 4, 6 and 8 or 10 way splitting
- Auto-Splitter with 3.8 second cycle time

Built-Rite Mfg. • 750 East Hill Road • Ludlow, VT 05149 • 800-757-2520 • info@built-rite.com

The Longest Lasting Debarker Head on the Market!

Why? Cutting Edge technology allows the carbide teeth to be indexed up to 6 times before they need replacing. That saves you money!

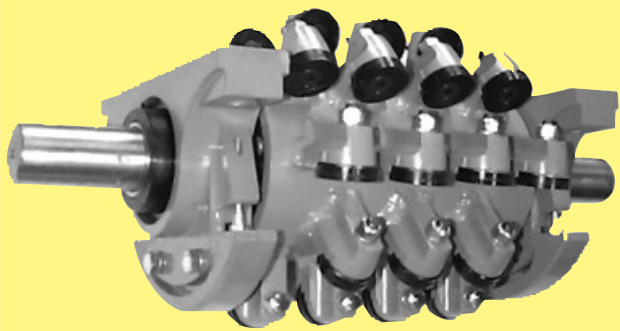

- 12" & 15" models
- Solidly constructed with All Steel bodies

The Bark-King Depth Control bearing can be used on many Rosserhead debarking heads to provide excellent control of the debarking process by preserving wood fiber.

Again — this saves you money!

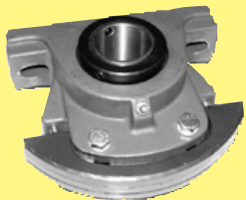

So, get the #1 performing head on the market AND save money!
Find out more by calling

Stringer Industries, Inc.

1-601-876-3376

Or visit www.bark-king-tools.com



The One Thing... Your Circle Sawmill Shouldn't Be Without!

The New **AccraMax™** Quick-Change Mandrel Drastically Reduces Downtime!

- ▶ Features removable wear plates that can be changed out in 15 minutes or less!
- ▶ Save time!
- ▶ Save money!
- ▶ Greater blade cut accuracy!
- ▶ Longer blade life!
- ▶ Faster feeding speeds!
- ▶ Higher consistency!

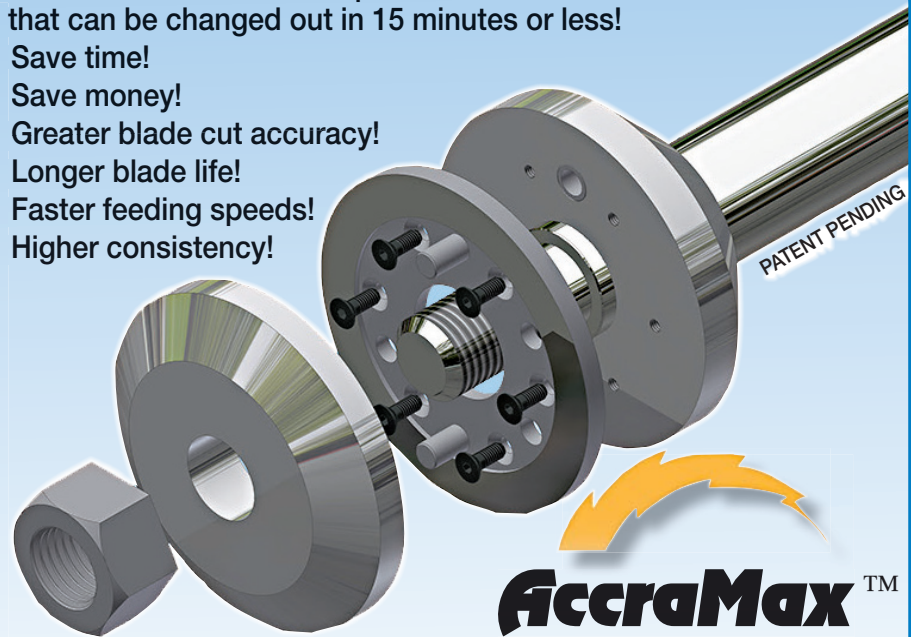

Plan Ahead — Cut Your Mill's Downtime. Time is Money!

AccraMax™
QUICK-CHANGE MANDREL

For more information, call **260-568-2534** or **260-589-2244** or visit www.accramax.com

Dealership inquiries are welcome

Up to 600 Pallets A Day With A Single Operator?

PROVEN!

You Can Do It With The Woodpecker Junior!

* It also runs recycled material.

* The Woodpecker Junior can now self-stack!



Building Mats or Crate Sides?

We can **custom build** a Junior Mat Machine based on your production needs...

Need More Production?

Produce up to **1,200 pallets a day with two men**
Take a look at the Woodpecker...



Viper Industrial Products is the **exclusive** distributor of Stutzman Mfg. Ltd, the **ONLY** manufacturer of Woodpecker and Woodpecker Junior Nailing Machines.



Del Wagner
217-621-2133
Viper-dwagner@alliancecable.net

Todd Mazur
501-679-6814
Viper@alliancecable.net

Live Floor Trailers

From Pickup Truck Beds to 53'

BUY • SELL

RENT • NEW & USED

Full Repair Service & Parts for Keith & Hallco Wet Kits, Hyd. Pumps, Valves, Hoses & More.

If You're Thinking LIVE FLOOR — **THINK FERGUSON FARMS!**

800-326-4919

Fax 574-453-3900 Cell 574-453-7120
We Now Handle Western Belt Trailers!

PACIFIC TRAIL
MANUFACTURING INC.

A difference that will keep you cutting!

888-910-SAWS

Making quality bars here since 1991

NEW BARS

WE REPAIR

ALL MOUNTS

SLASHER BARS

DOUBLE END

Hand made from 500bhn alloy steel. Harder than hell but will not break!

All your 3/4" pitch needs.

Direct from us, the manufacturer!

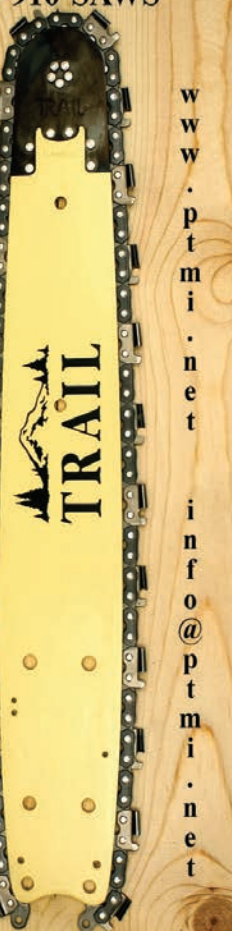

w
w
w
.
p
t
m
i
.
n
e
t

i
n
f
o
@
p
t
m
i
.
n
e
t

We Manufacture Short Studs & Pallet Cutstock

KD HT HF/DF/SPF 1x4, 1x6, 2x4, 2x6
Any length Cutstock.
Flatbed delivery.

Also: Green 1x4, 1x6 MRR

Call **1-800-447-3792**

e-mail: tjforest@gmail.com

Attention Southeast Pallet Operations -

We offer Pallet Cut Stock delivered to your plant. Reasonable prices - Reliable delivery!

We also supply:

- Crating products
- Packaging products
- Treated Materials
- SYP Plywood, OSB
- SYP Lumber
- Particle Board, MDF
- Hardwood Lumber
- Import-Export wood products



Magnolia Forest Products, Inc.
P.O. Box 99 • Terry, MS 39170 • Fax: 601-878-2589

Call 800-366-6374 or 601-878-2581

PALLET CUTSTOCK

Northern Dense
Hardwood & Aspen
Deckboards & Stringers
Notching Available
We Are Now Offering ISPM15 Compliant
Heat Treating For Our Lumber

Also Available Anti-Mold/Stain
Treatment

Sagola Hardwoods, Ltd.

For the highest quality & best prices,
contact: Steve Shirkey

Phone: **906-542-7200**

Fax: **906-542-3524**

E-mail: steveshirkey@att.net

**Are You Using The
RIGHT Lumber Markers?**

AMARK gives you the best
Quality, Price & Service!

Shop online at www.amarkers.com

e-mail: sales@amarkers.com

Call toll free **1-866-662-6275**

**USED
EQUIPMENT**

We own what we advertise!
**New Equipment
Arriving Weekly**



866-546-8864

<http://pallet-repair.com/viewused.asp>

PalMate^{ERP}

defining efficiency



Revolutionizing Recycling & Timber Operations





- Simplified inventory management
- Paperless BOL processing
- Streamlined production & delivery scheduling
- Track piece rates & productivity
- Forklift mounted tablet PCs and Bluetooth scanners



www.PalMateERP.com

Automated Machine Systems, Inc. | 877-267-8384



Cut Downtime and Keep Your Current Equipment Running!

**Count on Brown For Low Prices,
Quality Parts and Superior Service.**



Sprockets
(Cast, Steel
& UHMW Plastic)



Chains
(All Kinds)



Pillow Block/Flange
Bearing Units



New/Rebuilt
Speed Reducers



Power
Drive
Units



**UHMW
Wear Plates
In Stock!**

KEEPING YOUR OPERATION RUNNING SMOOTH FOR OVER 50 YEARS



800-748-9801
Fax: 870-246-8044
www.brownmachinery-supply.com
P.O. BOX 9, ARKADELPHIA, AR 71923
info@brownmacsupply.com

**WE REBUILD
MONTGOMERY HOG
ROTOR ASSEMBLIES**



ELLISON SALES, INC.
Toll-Free: 888-244-0161
dan@ellisonsales.com

THE ULTIMATE TIMBERWOLF[®] BANDMILL BLADE

2" x .052"

THE PERFECT WIDTH & THICKNESS
+ SWEDISH SILICON STEEL
= A NEW STANDARD

NOW ORDER ONLINE
WWW.TIMBERWOLFBLADES.COM

See In Action!
The Perfect Bandsaw Blade for ANY Sawmill or Resaw Brand!



Suffolk Machinery Corp.
800.234.7297

**Order
Yours
Today!**

BUYING **Red Aromatic Cedar Logs**
 By the foot or by the ton all year.
Call For New Pricing!
 MILLER'S CEDAR Call Allen . . . Let Ring
 HORSE CAVE, KENTUCKY **270-786-4316**

Minimize Log Splitting
 Save time and money by quickly inserting our heavy 14 ga. S-irons into the ends of logs and timbers to reduce splitting or checking. Unique ribbed design provides greater holding power. Available in 4", 5" or 6".
QUOTES ON REQUEST
 1-800-325-3770 fax: 636-305-1119
 WESTERN WIRE PRODUCTS CO
 Since 1914 770 Sun Park Dr. Fenton, MO 63026
 www.westernwireprod.com sales@westernwireprod.com

THERE ARE MANY REASONS WHY YOU NEED TO KNOW WHAT YOUR MILL IS WORTH
EQUIPMENT & INSURANCE APPRAISALS • MARKETING PLANS • LENDERS
You have the right to choose your insurance appraiser!
 See Our New Appraisal Website Today! www.kittrellappraisals.com
 See Our New & Easy To Use Equipment Site! www.kittrellsawmillbrokers.com



KITTRELL APPRAISALS
 Forestry Equipment and Consultation
931-698-3342

BE SURE YOU SPEAK WITH JACQUELINE KITTRELL,
OWNER, APPRAISER, AUCTIONEER, REAL ESTATE BROKER, CAGA



info@kittrellappraisals.com • Fax: 931-231-1051 • Office: 931-797-6284 • Firm #5745

PRINTERS FOR THE PALLET INDUSTRY



444SM-PALLET PRINTER

- Cost-effective alternative for placement of HT, IPPC information on each and every pallet.
- Capable of mounting to automated pallet machines.
- Saves time and money compared to manually hand stamping or spraying information on pallets separately.
- Velcro backed hubs allow quick and easy changes to information placed on pallets.
- Spring tension maintains contact and even printing on every pallet.
- Fully adjustable.
- Permanent stamps and information.
- **7 different colors of ink and ink rolls available**

CLAUSSEN ALL-MARK INC.
 8795 Grissom Pkwy. - Titusville, FL 32780
PHONE: 800-252-2736 FAX: 321-607-5071
 Email: sales@claussenallmark.com • www.Claussenallmark.com

Engines, Power Units, Gen-Sets
 Detroit Diesel, S53, 71, 92, 60
 Remanufactured & USED
New & USED Parts
 Twin Disk & Rockford Clutches & Parts
 Power Unit Radiators & Gauge Panels
Specializing in

DETROIT DIESEL 

Leid Diesel Service
Now 3 Locations to serve you:
 267 Green Hill RD. - Newville, PA 17241
717-776-7725
 N12574 Cty. Hwy. M - Thorp, WI 54771
715-669-3799
 2952 W. Carson City Rd. - Sheridan, MI 48884
616-754-5871

WANTED TO BUY

- #2 Pallet Lumber
- Line Bar Shims
- Hard Maple 4 x 6's, *Special Pricing*
- Cross Tie Siding
- 4 x 6 Cants

Elora Pallet Shop
 Elora, TN
931-469-5558

K.M.C. Model 882HD Double Bandsaw

We can provide the best machine to meet your application and production requirements!



- ✓ Self Adjusting Catty Track Hold Down System
- ✓ Harden & Baked Chrome Steel Paddle w/Lubrication System
- ✓ 18" Min. Length
- ✓ 3/8" to 6" High Material Climb from Blade Height — Optional 12" Climb
- ✓ Max Cut Height 8"
- ✓ Max Cut Width 8"

OPTIONAL: Digital Readout • Rubber Belt or Harden Steel Chain Feed • Floating Air Guide • Head Drive, Electric, Hydraulic or Lineshaft • Hydraulic Power Unit

717-859-4977

KEYSTONE  MACHINERY CORPORATION
 20 Cocalico Creek Rd. • Ephrata, PA 17522

www.keystonemachinery.com Fax: 717-859-4979

Think Plastic Can't Handle Your Weather? We'll Prove It Can!



January Steel Special
5/8" x .023"
49¢ /lb



Transportation is more affected by the weather than it's ever been.
Stock up NOW!

800-362-9332

Call Henry, Verna, Susan, Sandra, Sarah, Amy, Jennifer, Emily, Gracelyn!



Check by Fax or Phone



Plastic
\$56.69/roll

With volume discounts!

& we'll save you money!



Tifton, Georgia
P.O. Box 7552, Tifton, GA 31793

Heat Treat Stamps



Branding Irons and Hot Stamps
Propane or Electric
ISPM 15 Compliant
also Available For Nailers



BrandNew Industries, Inc.
(800) 964-8251
BrandNew.net

SAWMILL OPERATION FOR SALE

Complete w/Cleereman 3 HB Carriage, 3 Saw Meadows Edger w/Laser Light, 275 hp Cummins PU w/1800 hrs., Mellott Log Turner and 6 Cylinder Deutz PU w/2000 hrs.

"Will Consider Selling Individual Pieces"

Located in Verona, MO
For more information, call
417-461-4175



Georgetown Hydraulic Unit

LEERAY & LUKE HORTON
218-372-4232
E-Mail: llsales@frontiernet.net

Need Hog Parts... NOW?
Don't Wait - Call The Hogman!

Toll Free 1-888-244-0161
www.ellisonsales.com

2 CHOICES for MORE FIREWOOD PRODUCTION!

NEW Model 18-20 Hornet Firewood Processor



18" Diameter, 24" Stroke

- Sell Bundled Firewood to Convenience Stores, Campgrounds, and State Parks
- Seven Bundle Sizes Available: Electric or Gas
- Wrap a Cord of Bundles Per Hour
- Wrapper Priced Under \$1,700



See our complete catalog at
www.twister-industries.com
chuck@twister-industries.com

Twister Industries

Phone: **(320) 679-9835**

Cell: (612) 390-9620

2266 Hwy. 65 • Mora, MN 55051

Hornet Processors, Bundle Wrappers, Re-splitters, Skid Steer splitters, Wood Splitters, Conveyors

Twister Hornet Model 2530 Firewood Processor



2-4 Strand Live Deck, Tandem Axles, 45 Gal. Fuel & Oil Cap.

Model 7 Saw Grinder

\$525
w/Grit Wheel

Vertical Edgers
Headsaws
Scraggs
Edgers

\$595
with Diamond Wheel

Tension Lever and Guide Pin assure accurate grinding and easy movement.

Jones Saw Tools 812-354-6981 or your local dealer.



"The Saw Boss"

Handle rotates 360° to the best operating position.

The Shorthorn Saw Grinder for Headsaws Scraggs Edgers

Powerful 8 amp motor

Roomy Handle

\$580

Motor pivots on base to quickly set lead angle.





**DOUBLE-CUT
SAWMILLS**
**Extremely
Fast!!**

Visit our website
for **NEW Products**
in 2016... *trim saws,*
edger outfeed finger,
rooftop chain deck

Complete Sawmill Layout Options with full line of
accessory equipment for the first transformation of wood
HELPING YOU TO GROW YOUR BUSINESS

Plantagenet ON Canada
(613) 673-1267
www.selectsawmill.com

Edger Problems?

- Alignment issues?
- Too many banana boards?
- Not cutting as straight as you need?
- Feed roller teeth lost their bite?
- Too many profits going in the chipper?

**No need to buy a new edger. Call the edger experts.
We'll make your edger run right
and make it work for YOU... profitably!**

What our customers are saying...
"The best solution for a stubborn edger."
"If your edgerman is busy all day, something's not right."
"From experience I would say having the edger worked on was
our quickest, best return on investment we've made!
Edger work is both money and time well spent."

Our services include:

- Complete edger box rebuilds
- Custom infeed tables & outfeed beds
- Precision alignment service (mandrel, rollers, in & outfeed and more)
- In-shop tested and run prior to final installation in your mill
- Plus lots more!

**Don't let your edger be a drain on your hard earned profits.
Call us today and you'll see a big difference in your edger operation
in just one week!**

Jeff Miller 574-370-5050 • email: jeff5743705050@hotmail.com



**REAL TUFF
Shavings Baler**
Ben Jones Machinery
Div. of Dickert Enterprises, Inc.
Industry's Most Trusted Source
800-241-8983
See more equipment at
www.benjones.com

Bandsaw Blades!

**Custom Welded – Immediate Shipment
Call for prices and sizes available.**

LENOX & **WOODMASTER**
MORSE & **KASCO**
SharpTech

SHARPENING SERVICES NOW AVAILABLE FOR 1", 1 1/4", 1 1/2", 2" BANDS

W-37 Wright Grinder
A compact, automatic grinder that is quick
to set up and simple to operate. Precision
cams produce excellent sharpness.



4800 SOLVAY RD - JAMESVILLE, NY 13078
1-800-952-8288
WWW.U-CUT.COM

ATTENTION:

Morgan, Baker and Woodmizer LT15,30,35,40,50

13'2 (158") x 1-1/4" x 042 = \$13.00 Delivered

13'2 (158") x 1" x 035 = \$9.50 Delivered

22' Palletmaster Bi-Metal = \$34.00 Delivered

New and current customers who see the add take advantage till the end of the year. Time to stock up! Why pay more?

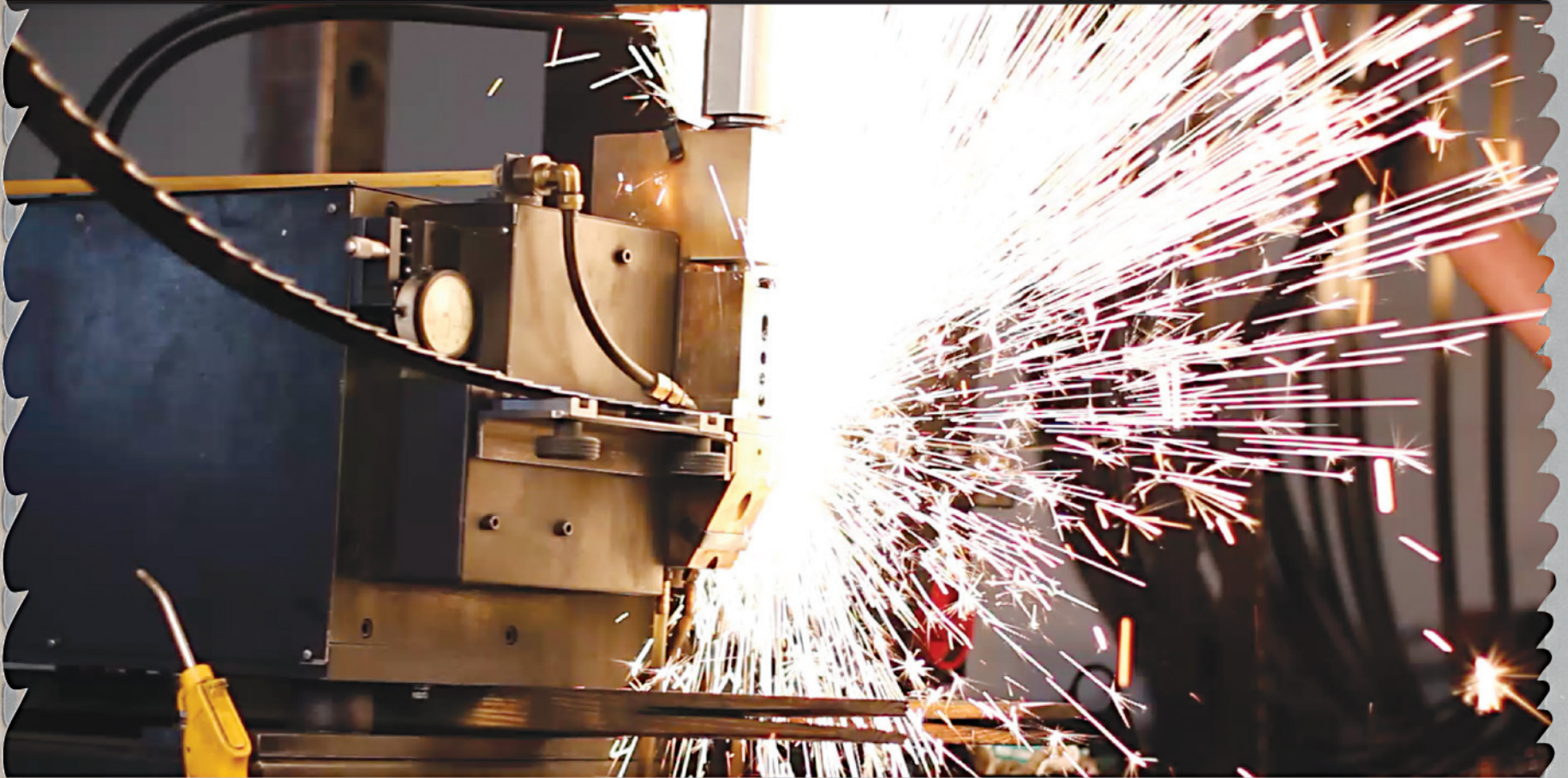

LENOX 

Wood-Mizer

**DAKIN
FLATHERS**

SIMONDS



**SOUTHEASTERN
METALS**

**NATIONWIDE
SHIPPING**

678-207-8550

www.semetals.net

Pallet Assembly Solutions from Mona Tracy...

**Thinking About Buying A Nailing System?
Universal Gives You Choices...**

**This Nailer Is Your
"NEXT STEP UP"
In Production!**

**New Universal
In-Line Nailing System!
Serious Stringer Pallet Production
Is Now Available...**

- Produces 1,200 pallets per day
- Eliminates use of hydraulic fluid for operation
- Up to standard size 64"x 84" pallet as its basic design (other size options available)
- Less air controls • Two or three man operation
- Fully automatic stacker • PLC controlled, no pneumatic switches



**Block Pallet
Attachment
Available!**

**The
"NAIL EASE"**



**Nailing
pallets has
never been
easier!**

- Assembles all size pallets (up to 50" x 50") with easy adjustments
- For New & Recycled lumber

**NAIL-MATE II
Flat Table/Manual Handling
Nailing Machine**



**Fast, Easy
Assembly
of Any Size
Pallets!**

**NAIL-MATE
Automatic Nailing Jig**

- 12 years proven in the industry
- Auto firing, one-man operation
- Handles 3 or 4-stringer pallets, wing pallets or others up to 56" x 50" at a rate of 1-2 pallets per minute!



**The "REVO" Revolving
Work Station**

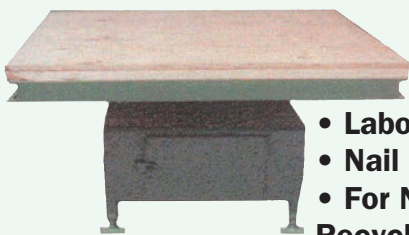

- Labor Saving!
- Nail at your own pace
- For New Pallets, Recycling or Reman jobs

**The
Nailing
Station**



- Hold down system and swivel turn over for nailing both sides
- Simple Construction of large, heavy & hard-to-handle sizes (any length possible)

**JAM DOCTOR
• Clears Nail Jams!**



**Sales: Mona Tracy
Universal Machinery Sales, Inc.**

Toll Free 1-855-298-8890

e-mail: sales.universalmachinerysales@gmail.com

www.universalmachinerysales.net

**Leasing
& Financing
Available**

NEW Like us on Facebook
~ New Specials Often!

Great Buys On Pallet And Sawmill Machinery!

**Large Selection
of used equipment
& misc. parts**



**Brewco B-800
Double Resaw**



Morgan Single

EDGERS

- Baker Slab
- Morgan Slab
- Fastline 8" Slab Edger w/Tailer
- Ribbit Edger

BAND SAWS

- Baker A Gas
- GoFast Single, Gas
- Kent 12"
- Baker A Line Shaft
- Baker 4-Head
- Fastline 4-Head
- Brewco B-800 Double
- Morgan Single

NOTCHERS

- Single Head Notcher

DISMANTLERS

- Disc Style
- Trace Trio

SAWMILLS

- Handset Mills

HMC Mill

- Edmiston 4 Head Block
- Helle w/Genset
- Forstall Mill
- Log Master LM-6
- Frick O1 Hydraulic
- Jackson 2-Head Block
- Meadows #2 Handset

**TRIM/
CHOPSAWS**

- Pop Up Saws
- Morgan 2-Saw
- Cornell Chop Saw
- West Plains Chop
- Brewer Chop Line
- Morgan Chop-All Air

NAILERS

- Pallet Chief II
- Pallet Chief 170"

Gap 960

- Viking® Duomatic

DEDUSTERS

- Baker
- Roblin
- GoFast
- Froedge

**CHIPPERS /
GRINDERS**

- 48" Precision Chip-Pack, 3K
- 58" Morbark Chip-Pac 6K
- 84" Precision Chipper
- Montgomery Hogs
- Challenger Horizontal
- Arasmith 50-48 HSS

DEBARKERS

- Manitowoc Flail
- Portable & Ring

GANG SAWS

- Cornell 500 B
- Brewer 8112 w/Sizer
- Cornell CLB
- Single Arbor w/Sizer

MISC.

- Barn Cleaner
- Chamfer Machine
- Blowers, Many Sizes
- Chip Screens
- Yates A-62 4 Head Planer
- Baker Runaround Sys
- Single Head Planer
- 250 KW Genset
- Timesaver Sander
- Industrial Plywood Cutter

Package Saw

- Stationary
- Cornell 8' Board Stacker

ROLLING STOCK

- Case Dozer 1550
- Barko 80 Loader
- Clark Forklift
- Bandit Chipper w/Loader
- Morbark 1500 B Slasher Loader



3 Strand Unscrambler



**Complete
Tipton Scragg
Merchandizer &
Cut-up Line**

Many Decks, Unscramblers and Conveyors

WANTED
Any Sawmill - Pallet Mill Machinery.
Call L&L Today.

LEERAY & LUKE HORTON

218-372-4232

8948 Market St., Sturgeon Lake, MN 55783

E-Mail: llsales@frontiernet.net

WWW.LLSAWMILL.COM

BELL'S FIREWOOD PROCESSORS

- o CAT Turbo Diesel Engine
- o 54" Circular Saw
- o 23.5" Diameter Capacity
- o Single Joystick Control
- o 42 Ton Splitter Cylinder



*Many Models
and Options
to Choose From*



Please Call for Details
1-888-995-1965
or visit us online
www.bellsmachining.com
Financing Available

**Need it FAST?
Need it RIGHT?
Call Ozark!**

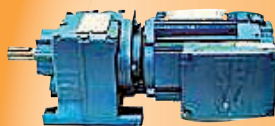

**Mill Chain and Sprockets,
Roller Chain and Sprockets,
Speed Reducers**

*Plus almost everything else to keep your mill running smoothly.
See our complete inventory at www.ozarkindustrial.com*



**Toll Free:
877-266-8202
Local:
870-269-8788**

www.ozarkindustrial.com Inquiries@ozarkindustrial.com

IN THE MARKET FOR USED/REFURBISHED HOGS... AND MORE?

CHECK OUT OUR INVENTORY FOR CAN'T MISS BARGAINS.



**Pallet Chief II,
10325.01-1**



**Edmiston Portable Sawmill,
10321.01**



**24-Unit Peerless Bin,
10312-1**

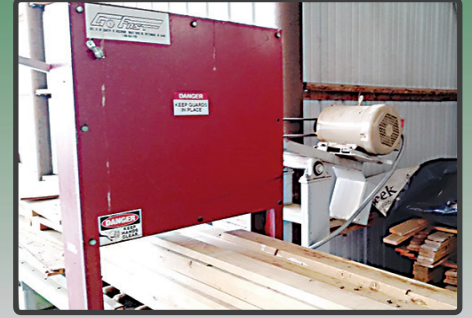

**Go-Fast Chop Saw,
10325.03-1**

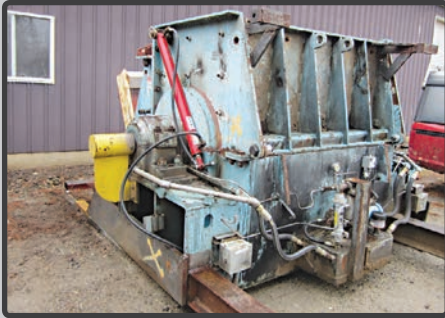

**Montgomery 57XLKC,
10225-3**



**Montgomery 45CSKC,
10076-1**



**Helle 3-Block Carriage,
10319**



**Jeffrey Horizontal Feed Hog,
100hp, 10264**



**Lamb 24x33 Hog Pkg.,
10273-6**



**Go-Fast Bandsaw,
10325.02-1**



**Montgomery 50PM-HZF,
10294-2**



**Montgomery 57XLKC Rotor,
10225-7**



**Rebuilt Montgomery 42PM-HZF,
10302.01**



**West Salem Magnet Belt Conveyor,
10272-10**



**Precision 58in 6K ChipPack,
10317-1**



**Single-Pass Dismantler,
10325.04-1**

**Already have a Montgomery Hog?
We supply all the parts you'll need!**



ELLISON SALES
Toll-Free: 888-244-0161
E-mail: dan@ellisonsales.com • www.ellisonsales.com

**Portland,
Oregon**

Your "Go-To" Source for Sawmill Supplies...

Wide Bandsaws * Shanks * Sawbits

Bartlett's Saw has supplied sawmills with better parts, supplies & service since 1978! Rely on us to keep your mill running right.



Need Wide Bandsaws, 4-8" wide, in single and double cut, 1 3/4" to 2" tooth space.

Guaranteed to run... right out of the box!



Our Shanks are so good, they're guaranteed!

If they split or crack, we'll replace them for FREE!

Check out our Sawbits... **The Eurobits & Econobits**



Call us to place your next order... **800-566-0319**

BARTLETT
SAW SERVICE & SUPPLY

621 US 41A • Henderson, KY 42420
e-mail: eric@bartlettsaw.net



Every product we manufacture and sell must meet our high standards before being shipped.

Guaranteed Products
+ Quick Delivery
+ Proven Experience
= Your Success

We also supply Edger Saws, Slasher Saw Bits, Saw Grinders & Lots More!

Used Machinery Call Mona Tracy Today

- 1- Pallet Shop, Ohio, NY, Iowa
- 2- Stake Machines - Pencil Point
- 1- 2 Head Trim Saw
- 1- Air Compressor - Phase Converter
- 1- Morgan Portable Scragg
- 1- Gas Band Saw Disassembler
- 4- Nailing Jigs/Tables, Revo
- 1- 3 Head Trio Disassembler
- 2- Morgan Nailers & Stackers
- 1- Hand Held Brander
- 1- 12" Wide Resaw
- 1- Band Saw Disassembler
- 1- Brewer D. A. Gang, Planer
- 1- Third Man Nailer
- 2- Pallet Kat Bandsaws
- 1- Baker A Single Resaw
- 1- KM-16 4 Head
- 1- Single Notcher 1- Chamfer
- Blowers, Phase Converter-40 HP
- 2- Morgan Dedusters
- 2- Solo, Pass I, Disassemblers
- 1- Tipper 1- Stacker 60 x 60
- 1- Complete Sawmill For Sale (NY)
- 1- Pallet Sizer - Resize Pallets
- Nailing Tables, Asst.
- 1- Military Band Notcher -2 Head
- 1- Gap Nailer 2- Rayco Pro
- 1- 4 Head Brewer w/Deduster
- 1- Baker Cut Off Saw
- 1- Cyclone Dust Collector Bag
- 1- Table Top Slinger/Plater

List your used equipment with us!

UNIVERSAL
MACHINERY SALES, INC.
Toll Free **1-855-298-8890**
or **812-298-8090**
E-Mail: info@universalmachinerysales.net

Precision 58" Chipper



Reduced to \$30,000!

1996 Model, 6-Knife, Accepts up to a 15" Slab. New Vertical Anvil, New Feed Plate, New Wear Band, New Holder & Clamps.

Call **270-754-4087**
(Robert or Anthony)

Try our tool risk free for 30 days!
NEW Tech® PCN-55M



The better alternative for pallet recyclers
More power, less weight & better durability.

For driving nails 1-3/4" to 2" with diameters .083" to .090", we proudly introduce the new Tech PCN-55M nailer.

After many years of experience working with pallet recyclers, we've designed our new tool with features like a thicker reinforced nose and contact arm for extra durability, and air flow that is optimized to generate more power with less weight - a third to a half a pound lighter than competitive tools.

Our customers also report that the new PCN-55M holds up better in colder winter temperatures.

Although nail pricing is one component when choosing a company, an even greater consideration for us is the nail guns. Being a recycler, wood density varies from softwood to rock hardwood. The Tech 55M handled all materials with ease. It has increased production by approximately 30%. A single individual was able to increase his output from 200 to 300 pallets per day, very impressive. Overall its proven itself as a money maker for the company.

- Steven Streeter: Enpac Pallets & Crates Inc.

METROPOLITAN
STAPLE CORP.
www.metrostaple.com
info@metrostaple.com
800-255-7209

PRECISION CUTSTOCK!

GOLDEN EAGLE GANG SAW SYSTEM

- Dust Free Lumber
- Single, Double or Twin Double Arbors
- Built-In Planer Sizer
- 8" to 25" Bay Widths
- As Thin as .125 Kerf in Double Arbors
- Variable Feed Rates

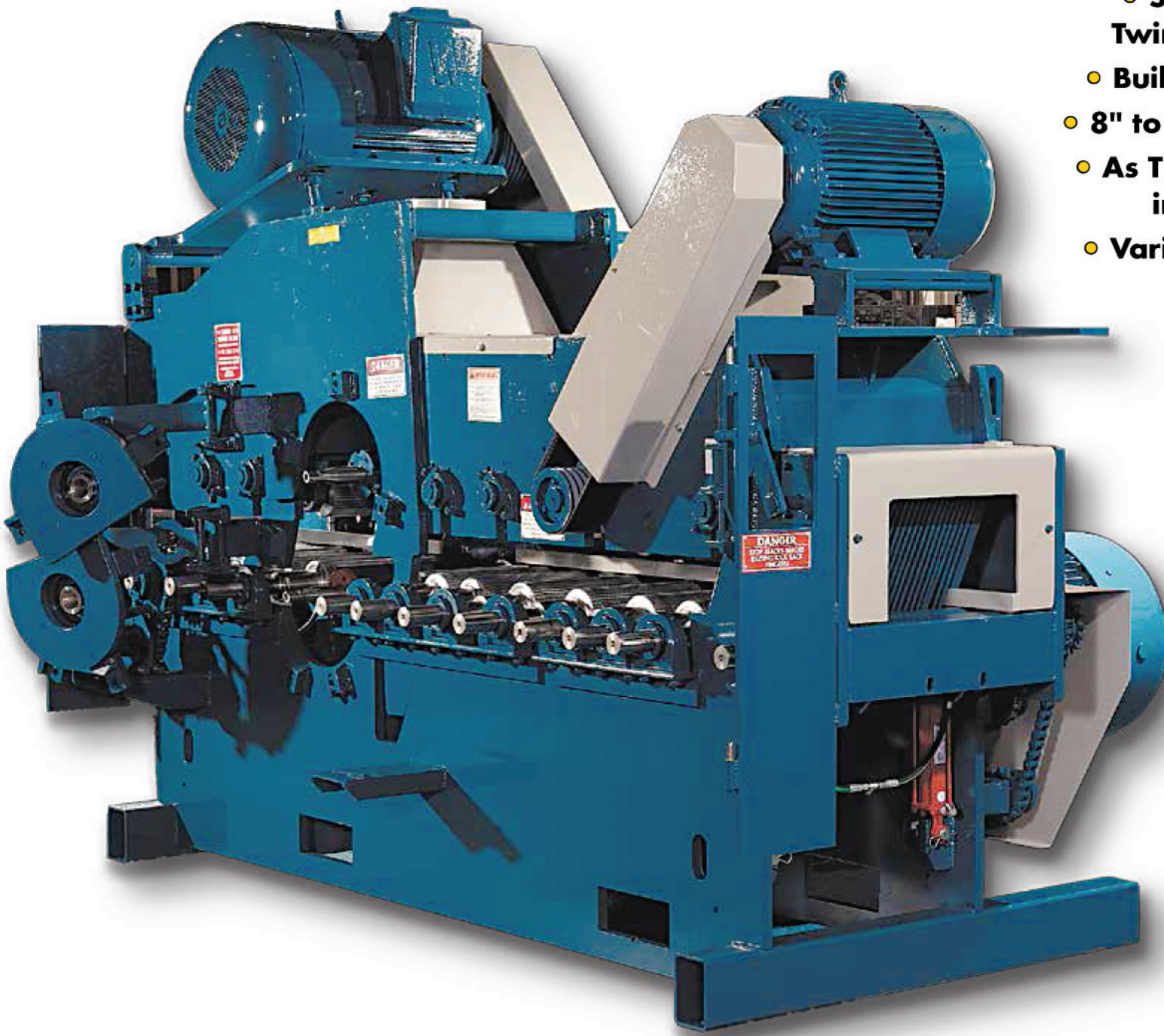

800-345-6516
www.brewermach.com

FULL PRODUCT LINES FOR PALLET, STAVE, GRADE AND RAIL TIE INDUSTRIES.

Pallet Recycling Solutions from Smetco...



Stringer/
Board
Splicer



Notchers



Trim Saws



Turntables



"Quick-Stack" System



Dismantlers



Single End
Trim Saw



Stackers

SMETCO also makes a complete line of repair and recycling equipment.



Sorting Systems

SMETCO, INC.
Pallet Handling Systems

PO BOX 560
AURORA OREGON 97002

Phone: 1-800-253-5400

Fax: 503-678-3095

www.smetco.com

sales@smetco.com



The Morgan Line-Up!



Original Single Head Resaw

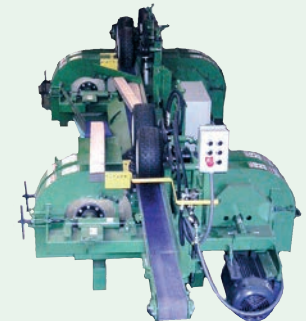

4-Head Resaw



Wide Cut Resaw

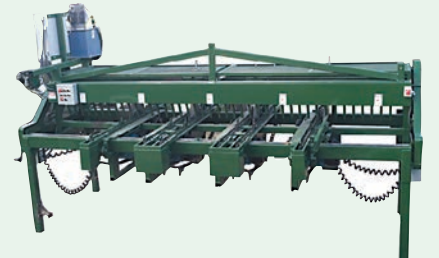

Multi-Head Trim Saw



Military Band Notcher

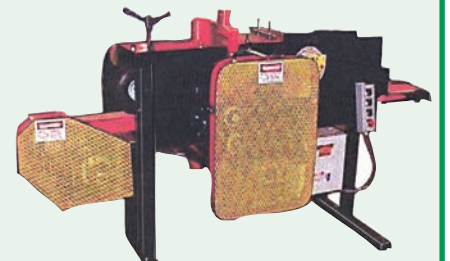

Board Duster

UNIVERSAL
MACHINERY SALES, INC.

Call Mona Tracy

855-298-8890
or **812-298-8090**

sales.universalmachinerysales@gmail.com

FOR SALE!



Brewco E-Z Cut

LEERAY & LUKE HORTON
218-372-4232
E-Mail: llsales@frontiernet.net

GOOD USED EQUIPMENT

- (2) GO FAST Dedusters
- KENT Single Head Notcher
- 2 Head End Trim Saw 60" Capacity

Call Today! **920-986-1145**

Stock Your Sawmill With The Best Saws
— Since 1890!



See our web specials at:
www.paynesaws.com

800-752-0627

NEED TO REDUCE LABOR AND INCREASE YIELD?



HAS SOLUTIONS FOR YOU

FROM
CUTUP
SYSTEMS

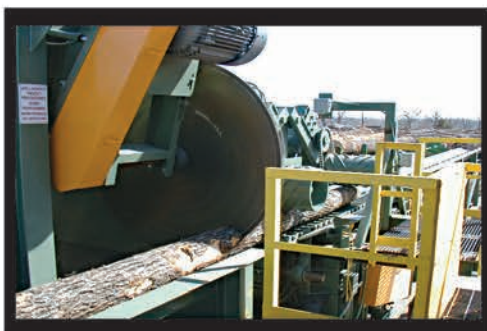

AND
EVERYTHING
IN
BETWEEN



TO
STACKING
SYSTEMS

YOUR ONE STOP FOR QUALITY CUSTOM SAWMILL EQUIPMENT SINCE 1965

DON'T WAIT, GIVE US A CALL AT 478-252-5885

EMAIL: INFO@COOPERMACHINE.COM WEBSITE: WWW.COOPERMACHINE.COM

YOUTUBE: WWW.YOUTUBE.COM/COOPERMACHINECOINC

Need Money Now?

PROBLEM:

You give your customers 30 days to pay...

SOLUTION:

GET YOUR MONEY NOW and still offer credit terms to your valuable customers!

Here's How It Works:

- Invoice today - Get paid today up to 80% on your invoices. The other 20% is paid to you, less our fee, when your customer pays the invoice.
- Flexible fee structure
- You do not incur debt!! This is not a loan
- No application fee and no long term commitments
- Grow your business with the increased cash flow
- Take cash discounts offered by your vendors

Turn Your Invoices Into IMMEDIATE CASH!

Working Capital From A Company That Works For You!



FACTeON
ONLINE FACTORING

Call **Steve Morgan** today at **888-673-3863 (fund)**

Apply online at www.facteon.com

OUR UNIQUE & INNOVATIVE WOOD DRYING PROCESS DELIVERS RESULTS



BRIGHTER LUMBER MEANS HIGHER SALES

Nova Dry Kiln's innovative technology offers a unique drying method that is kinder and gentler to the wood drying process. This process results in brighter lumber and gives our customers higher sales. Nova Dry Kiln builds and designs medium and large kilns ranging from 5,500 to 120,000 or more board feet.

TIMBER DRY MANAGEMENT CONTROLS OFFER FLEXIBILITY AND EASE OF USE

When using the Timber Dry Management System kiln operators have a straight forward, simple to use, flexible program. Kiln operators can make instant changes on the touch screen interface that is provided for each individual kiln. This drying control technology uses the exclusive proven and cost-saving Nova Dry Kiln methodology.

CONTACT US FOR FURTHER DETAILS

We provide turnkey construction services along with excellent customer service as part of our dry solutions. Call our technical staff today for further information about Nova Dry Kiln and our Timber Dry Management system.

INNOVATIVE TECHNOLOGY SAVES MONEY ON UTILITIES AND DEGRADE

Our kilns not only save money on utilities but our customers experience end results of only a 1 to 1 1/2% degrade. Using the combination of a thermal blanket created from our heated floors, with fans that do not reverse rewetting the lumber surface, also moisture is not reintroduced into the drying chamber for humidity control or conditioning, to the aluminum-lined walls that offer a superbly insulated chamber, the Nova Dry Kiln saves you money on your utilities and provides you with a superior end product and in most cases only a 1 to 1 1/2% degrade.



Ask about our Pallet Treating Kilns & Firewood Kilns

1-502-409-4539

www.novadrykiln.com • e-mail: info@novadrykiln.com



For Many Years The Wood Industry's Most Trusted Source For Previously Owned Equipment!



\$6,000

**FEATURED ITEM
OF THE MONTH**

**FULGHUM
48" Chipper
(Item #55990)**

Give Us A Call Today!

Search Our Complete Inventory at www.benjones.com



HMC 2-Saw Trimmer



EDMISTON Edger



85' Green Chain



PRECISION 58" 6-Knife Chipper



8' Lumber Stacker



TYRONE BERRY 270 Carriage Drive



RECKART Cant Catcher/Slab Drop



ARMSTRONG Bandsaw Bench

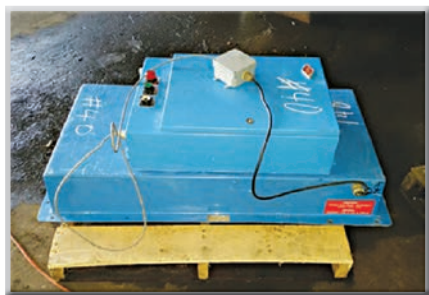

MDI Metal Detectors (New & Used)



MORBARK 26' Vibrating Conveyor



KENWELL JACKSON Notcher



KOCKUMS 24" Cambio Debarker



UNITED 144" Magnetic Knife Grinder



PEERLESS 30 Unit Chip Bins, pair



PSI 170' Log Crane



JEFFREY 44 AB Wood Hog



Ben Jones Machinery

*Div. of Dickert Enterprises, Inc.
Industry's Most Trusted Source*



800-241-8983

Ken Dickert, President

Eric Doss 706-478-1581

Jim Lichucki 706-478-5498

Ken Dickert 706-478-1571

sales@benjones.com



**** Financing Available **
www.benjones.com**

We'll Ship Your Order — Log Decks, Lumber & Transfer Decks, Rollcases, Log Turners — Within 7 Days!

That's right! You know that Meadows equipment is made with the highest quality components and engineered to last. Now get any of our material handling equipment shipped when you need it — right away!



**Rollcases
& Jump
Transfer
Decks**

Custom rollcase to fit your installation
2-6 strand decks, length to fit,
single or dual kick-off system for lumber,
cant & waste sorting.
Plus **Green Chains & Grading Decks**
— all **GUARANTEED** to ship within 30 days
of drawing approval!

**Why wait?
Get your
next project
moving...**



**Log
Deck**

2, 3 or 4-strand,
customized length and spacing
to fit your application

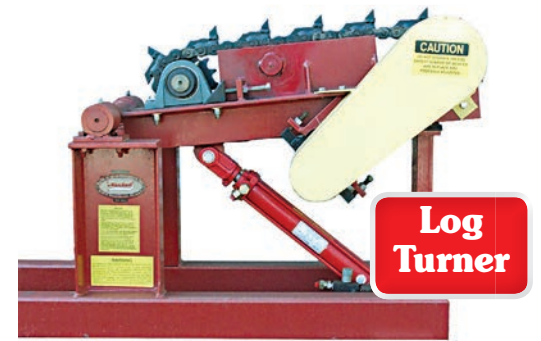

**Log
Turner**

Hydraulic motor, 120H chain

Call Meadows — Trusted by Sawmills for over 100 years!

**MEADOWS MILLS, INC.
800-626-2282**

www.meadowsmills.com • e-mail: sales@meadowsmills.com



MULTI-HEAD END TRIMSAWS BUILT BY THE MORGAN FAMILY

PROCESSES BOARDS OR CANTS WITH PRECISION ACCURACY AT TOP PRODUCTION!



- AVAILABLE IN 2, 3, 4, & 5 HEAD MODELS
- EACH ONE EQUIPPED WITH 20" CARBIDE BLADES AND A 10 HP MOTOR PER HEAD
- ADJUSTABLE HEADS WITH VARIABLE FEED SPEED
- SPRING LOADED ADJUSTABLE HOLD DOWNS
- 5 HP HYDRAULIC UNIT POWERS CHAINS

**» OPTIONAL EQUIPMENT INCLUDES «
LARGER BLADES (22") AND MOTOR (20 HP)
PLUS PRODUCT AND WASTE CONVEYORS**

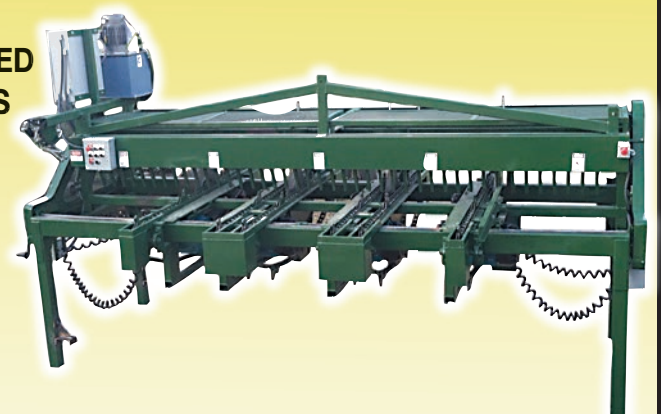

**A family owned business. Builders of the ORIGINAL Low Profile Band Resaw.
Need parts for your Morgan Saw? We've got 'em!**

**Sawmill Supplies
& Equipment LLC**
Sarepta, LA
318-994-2116

e-mail: sawmillsupplies@centurylink.net
www.sawmillsupplies.net

**Sales Office:
Mona Tracy**

**Universal Machinery Sales, Inc.
1-855-298-8890**

e-mail: info@universalmachinerysales.net
www.universalmachinerysales.net

READY TO INSTALL & READY TO RUN...

Select **SPECIALS** at www.LPS-INC.com



Morbark 48" Chip Pac



Brewco Band Head Rig



Rebuilt Salem 6' Band Head Rig



Like New Precision 48" Chip Pac



West Salem 2822 Horizontal Hog



Nicholson 104" Chipper



30 Bay J Bar Bin Sorter



Newnes 20' Optimizing Trimmer



Newnes Optimizing Edger



Newnes 10" Thin Kerf Gang



Brewco 800 4 Head



Portable Radial Stacker



Portable Truck Dump



Newman Double End Trim



Can Car Chipping Saw



Nicholson A1 60" Ring Debarker



Nicholson A5 22" Ring Debarker



Rotochopper EC124 (2) Available

LPS HAS IT IN-STOCK! GET IN PRODUCTION FAST!
SAVE TIME & MONEY!



SCMI Compact 22 Moulder



Timberland Deduster



Kohler 150 KW Gen Set



Dust Collection System



Overhead Truck Loading System



MEC 1035 Triple Pass Dryer



Brewco EZ Cut 4 Head Resaw



MEC 1240 Triple Pass Dryer



CMC Modular Mill w/Vertical Edger



Precision 66" 6 Knife Chipper



Several Chip Bins



BM&M 5x10 Chip Screen

LPS EQUIPMENT & ACQUISITION CO.
 731-986-4351 | sales@lps-inc.com

800-598-3651
WWW.LPS-INC.COM

STREAMLINE LASERS



OUR MOST POPULAR ELD-15

IS THE INDUSTRY STANDARD FOR LONG LIFE & DURABILITY

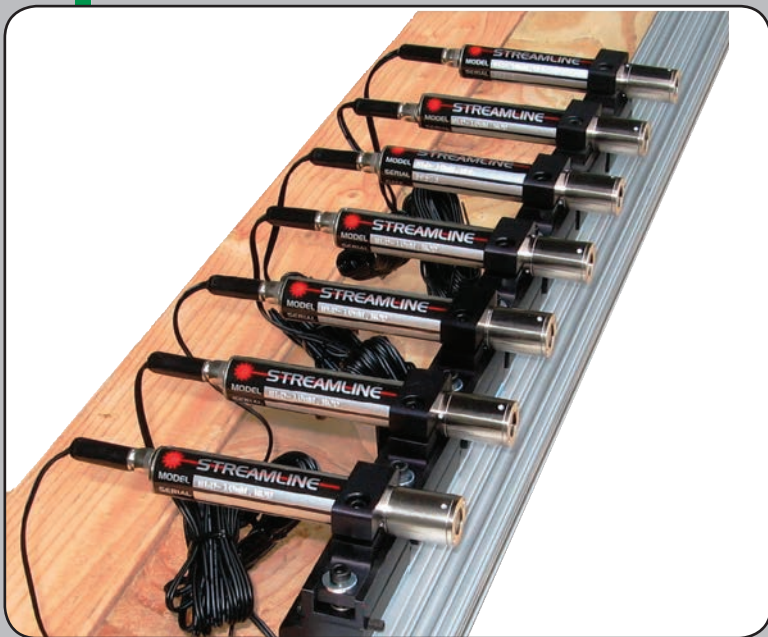

Get It All

- Cost Less Up Front!
- Longer Useful Life (*means it costs EVEN LESS!*)
- Superior Components
- Standard & Premium Grades Offered
- Straight Talk – we ONLY sell you the laser YOU NEED!
- Two Year Warranty on Most Lasers Sold
- Thinking **GREEN** Lasers? Call to Get the FACTS FIRST!

The EGL Has Landed... Again!
The New EGL Series of
Green Diode Lasers

- * *Economical*
- * *Precise*
- * *Enhanced Visibility*



Before you Buy ANY LASER –
For ANY Forest Industry Application
Call Ellison Sales FIRST!



Shift Kits Available for Moveable Saw Applications

The Laser Choice Since 1972 – Over 40 Years Of Laser Manufacturing and Straight Talk



ELLISON SALES
Toll-Free: 888-244-0161
E-mail: dan@ellisonsales.com
www.ellisonsales.com

kiln-direct.com

The leading provider of kilns for lumber, pallets and firewood



- Portable turn key units with fast treating time
- Heat treats and dries in the same chamber
- Computerized record keeping
- High efficiency direct gas heating
- Aluminum or stainless steel chamber
- End-load models 300-1000 pallet capacity
- Side-load models 280-700 pallet capacity
- Piggy-back system for insulated van body or container



- Wood waste or gas heat
 - Easily meets 160F/75mins
 - Heat treat in 8-16 hours
 - Kiln dries green firewood in 1-2 days
 - 6 cord (MiniQuick) up to 24 cord
 - Baskets for optimized airflow are available
- MiniQuick firewood kiln has been specifically designed to dry and HT firewood quickly and efficiently



- 100% aluminum construction
- Gas, hot water or steam heated
- Power venting with Heat Recovery
- Bi-fold door with electrical operation is optional upgrade
- Computerized control with wireless communication to office
- Loading capacity from 9000 bf to 21000 bf

Call us today and find out how our pallet, firewood and lumber kilns can increase your profit...

phone 910 259-1624
fax 910 259-1625
www.kiln-direct.com

P.O. Box 159
200 A Progress Drive
Burgaw, NC 28425

Pallet Dip Tank Key Design Features:

- Dip tank is fabricated in 1/8" thick stainless steel, type 304, with external painted enamel mild steel structure.
- Standard pallet carriage for pallet stack up to 114" tall and maximum 2500 lbs weight. Dead packed cut stock can also be dipped.
- Tilting carriage is fabricated in stainless steel and mild steel.
- Tilting carriage has clamp system to insure pallets or lumber is submerged.
- Hydraulic system is used for all mechanical operations.
- Estimated dip cycle for pallets is 4 minutes and is user defined.
- PLC control system with remote control for initiating the dip cycle. Dip time and other parameters are adjustable in the control cabinet display.



Eagle Dip Tanks Complete Dip Tank Systems

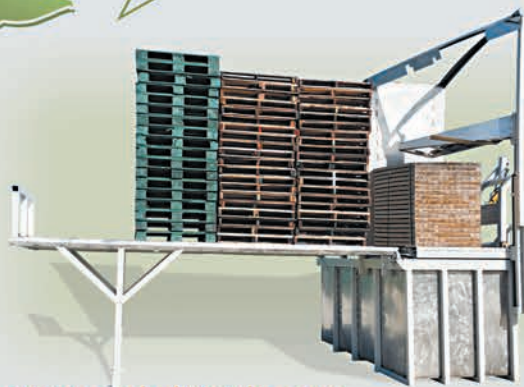

www.eaglediptanks.com
910 259-9794

Need Parts to Fit Your Morgan Saws?

Sawmill Supplies & Equipment, LLC supplies, parts and more!

Office: 318-994-2116
www.sawmillsupplies.net
E-mail: sawmillsupplies@centurylink.net

Still Building the ORIGINAL Low Profile Single Resaw

STILL THE FASTEST SWING SAW FOR MOST CUT-OFF OPERATIONS

FAST!

The H & A Swing Saw

- Up to 72 Cuts Per Minute
- Greater Capacity & Easiest Operation
- 3 Models All w/Best Safety Features

"Plants" Using OSHA Inspected & Approved

Call 1-800-397-3703
H & A Swing Saw Inc. • Since 1921
PO Box 127 • Lockridge, IA 52635

www.hasaws.com
email: hasaws10@lisco.com



PIPER'S SAW SHOP

1-800-845-6075



YOUR SOURCE FOR

EVERYTHING

SIMONDS



SIMONDS RED STREAK®
Narrow Kerf Bandsaw Blades

SIMONDS INTERNATIONAL

NOBLE MACHINERY CO.

- New Pallet Hawg Band Dismantler, In Stock
- New Waechter Power Feed Trim Saw
- Baker A Sgl. Resaw w/Go 'Round Return
- Bronco 200 Nailing Machine
- Cemco 54", 84", 120" 6 Spdl. Vert. Borers
- Hazlethorn R-180 24" Up-Cut Saw
- Hazlethorn T-145 10" Wide Cant Sizer
- Heartland Dbl. Head Resaw w/Return
- Ind. Resources Pass One Disc Dismantler
- Mid-Oregon Trim Scrap Grinder
- Morgan Double End Trim Saw
- Morgan Board Sizer
- Piche 4-Saw Trimmer w/Conveyor
- PRS Chain Feed Trim Saw
- Rayco Pro Pallet Nailer w/Stacker
- Smart Portable Band Saw Dismantler
- Smetco Tru-Cut Notcher
- Third Man Nailer
- Visionary Stake Pointer
- Waechter 2-Head Horiz. Resaw
- West Salem 2-Stage Vertical Grinder
- Willow Creek Economy Notcher
- Rebuilt Whirlwind Up-Cut Saws
- Parts for FMC, Hazeldine & Morgan

1-800-348-0703
www.noble-machine.com
E-Mail: noblemach@aol.com

We Specialize in Dense Hardwood or Poplar:

- Pallet Deckboards (1x4 & 1x6)
- Stringers (Notched & No-Notch)
- Band-Groove Components
- Custom jobs no problem

For more information

Contact: Keith Barbo
E-mail: kbarbo@wvsr.com
304-472-8131 ext. 111
or 304-439-0392 Cell
Fax: 304-472-0212

WV Forest Products
Website: www.wvsr.com

PO Box 9, 16 Lumber St. • Buckhannon, WV 26201

Equipment For Sale

- ✓ Used Montgomery FR40 carriage, 4 tong dog, set works, 10" wheels, kickers.
- ✓ (4) Montgomery FR tong dogs, air, 3 w/kickers. Fits Corinth, Meadows #2 mills.
- ✓ Hyster Pioneer 80 diesel yard lift w/new pump, steering cylinder.
- ✓ Frick wheels, axles & bearings for wood mill.

Call **1-888-806-8805**
Email: sales@MontgomeryEquipment.com

PARTS & SERVICE
Forest-All, C.M.C., C.S.P., *35 Years Experience!*
Hilltop Equipment
DICK NOLIN SAWMILL SERVICE
603-724-3942

Kittrell Sawmill Equipment Listings

Call **Jacqueline Kittrell To Locate or Sell Equipment**

www.kittrellsawmillbrokers.com

931-698-3342
931-797-6284

PO BOX 505, COLUMBIA, TN 38402



Cleereman
75 HP Carriage Drive (PA)



36" Cleereman (4) HB
Straight Line Carriage (PA)



Precision 636 Slant
Track Debarker (TN)

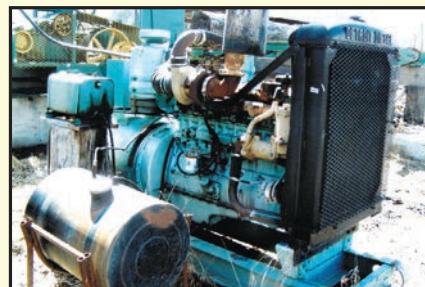

Onan
350 KW Genset (IL)



Cleereman
36" Modular Mill (IL)



ALH 16' Trimmer
(PA)



80' Mellott (4) Strand
Green Chain (PA)



Precision 48"
8KN DFTD Chip Pack (TX)

✓ **OUT OTHER LISTINGS ONLINE. NEED TO SELL SOME SURPLUS MACHINERY? CALL US NOW TO GET STARTED.**

Email: info@kittrellappraisals.com

Total Log Scale Inventory Solutions

Software • Caliper • Barcode scanner • GPS • Logtags

Now offering a complete line of tools to keep track of your inventory from start to finish

- DP II Caliper—An all-in-one rugged computer caliper that allows you to scale logs. LogScale DP software is designed to collect, process and report any load and log data and send that data to a Log Scale Suite for Haglof Management System's database.
- DP SCANNER barcode scanner module for DP II caliper, scan and store the barcode with the caliper.

- Log Scale Suite for Haglof Management Systems - Use it to create and manage contracts, price lists, tickets and loads as well as scale logs, calculate volumes and manage log inventories.
- LogTags—Durable plastic tags with many styles available to choose from to fit your needs and let you stand out. We even carry bio-degradable tags that are safe for the pulping process.



HAGLOF INC
100 Solleftea Drive • US-39130 Madison, MS • USA • Phone +1-601-856-5119 • Fax +1-601-856-9075
sales@haglofinc.com • www.timbercruise.com • www.logtags.com • www.haglofinc.com



KASCO WOODMAXX Premium Band Saw Blades

CUTS WHAT OTHER BLADES CAN'T

MAXX4 4° Hook Angle
for frozen wood and extreme hardwoods; maximum performance on all horsepower saws

MAXX7 7° Hook Angle
for frozen wood, tropical woods, and extreme hardwoods; great for wider cuts on all species; performs better on higher horsepower saws

Both are available in 7/8" tooth spacing (1.1 TPI) on 1-1/4" x 0.042", 1-1/4" x 0.045", 1-1/2" x 0.050, and 1-1/2" x 0.055" bands.

877.366.1696
www.WoodMaxxB Blades.com

Need Parts to Fit Your Morgan Saws?

MILITARY BAND NOTCHER



- 5hp motor
- Hydraulic adjustable feed
- Indexable carbide cutters
- Adjustable width & height
- Can custom build

Sawmill Supplies & Equipment, LLC

- Board De-Dusters
- Multi-Head Trim Saws
- Product & Waste Conveyors

Office: 318-994-2116
www.sawmillsupplies.net
E-mail: sawmillsupplies@centurylink.net

Call Mona Tracy
1-855-298-8890 (toll free)
sales.universalmachinerysales@gmail.com
universalmachinerysales.net

Still Building the ORIGINAL Low Profile Single Resaw

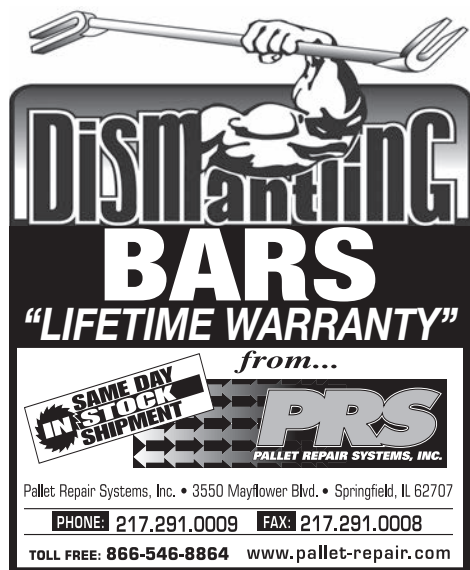

Dismantling BARS
"LIFETIME WARRANTY"

from... **PRS** PALLET REPAIR SYSTEMS, INC.

SAME DAY IN-STOCK SHIPMENT

Pallet Repair Systems, Inc. • 3550 Mayflower Blvd. • Springfield, IL 62707
PHONE: 217.291.0009 FAX: 217.291.0008
TOLL FREE: 866-546-8864 www.pallet-repair.com

Row Electrical Equipment, Inc.

P.O. Box 2812 • Toledo, Ohio 43606

Your Source for Used & Reconditioned:

- Squirrel Cage Motors
- Gear Motors
- Wound-Rotor Motors
- Synchronous Motors
- DC Motors
- Phase Converters
- Adjustable-Speed Drives
- Generators, AC and DC
- Engine-Generator Sets
- Transformers, Single Phase
- Transformers, Three-Phase
- Across/Line Starters
- Reduced Voltage Starters
- Safety Switches



24 Hours a Day Call **800-248-4479** • We Buy Used Electrical Equipment
Visit our website: www.rowelectrical.com • Email: rowelec@glasscity.net

Mixed Hardwood Pallet Cutstock

- 1/2" - 1" Thickness
- 30" to 60" Length
- 3 1/2" - 5 3/4" Width

Stringer Orders Wanted
(Stringers Available in Hardwood and Green Pine)

#2 Pallet Lumber Available at Greatly Reduced Pricing!
(Heavy on 40" & 44" Lengths)

Call Todd or Lisa: 931-296-1455
trichardson@waverlywood.com

Waverly Wood • Waverly, TN

AMBITRIM GANG TRIM SAW



CALL US FOR MORE INFORMATION!

BAKER Products LIKE US ON FACEBOOK!

The Baker AmbiTrim features two up to eight 18" diameter circular saws, set at either equal or various distances from each other. Each saw head can easily be positioned independently using a lockable saw head positioner. As boards are fed in laterally, these saws cut them into shorter pieces all at once.

573.663.7711 800.548.6914 BakerProducts.net info@BakerProducts.net

CEMARLINE®
www.cemarelectro.com

DRAGON

CEMAR ELECTRO INC.
LASERS

GREEN!
5,15,30,50mW

5-30 mW RED LASER

- Industrial Strength
- Patented Linear Optics
- 48-Hour Repair Service
- Powershift™ Technology
- 2-year Warranty

Call Toll Free Today:
1-800-298-5273
Fax: 518-298-2927

Montgomery Hog Parts New & Repaired • In Stock

Check out our prices

All the parts you need to keep your Montgomery Hog running at its best

Teeth • Anvils • Lug Inserts
Rings • Rotors • Screens

Don't guess dimensions or design
Buy from the people with the prints

& beware the pirates!

Protect your investment with parts engineered to perform.

MONTGOMERY
INDUSTRIES INTERNATIONAL

2017 Thelma Street • Jacksonville, Florida 32206
Ph> 904.355.5671 • Fax> 904.355.0401
www.montgomeryindustries.com

MILLTREE™
LUMBER HOLDINGS
A MILLWOOD, INC. COMPANY

Hardwood Pre-Cut Pallet Material

- #1 and #2 Material (Available in deck boards and runners.)
- Various Sizes & Lengths

Other Products Available
Sawdust • Mulch • Raw Bark • Boiler Fuel
Chips • Chunk Wood • & MORE

Call **740-226-2090** | www.millwoodinc.com

CSI Crosscut Solutions, Inc.
E5763 County Road B • Manawa, WI 54949
Ph: 920-596-2330 • Fx: 920-596-2324
crosscut@wolfnet.net

Pneumatic OR Mechanical

The industry's most durable pneumatic and mechanical cut-off saws, delivering smooth, accurate cuts for the manufacturing of flooring, windows and cabinets. Both saws are available with a cool mist lube system for the processing of aluminum.

Available in left or right hand

Mechanical Saw -
No compressed air required

Pneumatic Saw -
Cushioned air cylinders

www.crosscutsolutionsinc.com

The Richmond Show

EXPO RICHMOND 2016

Richmond Raceway Complex * Richmond, Virginia
 Friday May 13th 8:30a.m. until 5:00p.m.

and

Saturday May 14th, 2016 8:30a.m. until 3:00p.m.

The 35th East Coast Sawmill and Logging Equipment Exposition



will be 2016's largest collection of sawmill, logging, biomass, pallet and related manufacturing equipment, supplies and services in the Eastern United States. More than 300 exhibiting companies and thousands of forest products industry people will convene for the 35th Richmond Show. The newest and most advanced machinery, equipment and technology in the industry will be on display. There will be acres of active hands-on machinery and equipment demonstrations outside, plus hundreds of indoor displays of new products, methods, technology and trends. Examine and compare products or services before making your purchasing decisions to improve the efficiency - and profitability - of your operation. Please fill out and return the pre-registration form below to the exposition office by April 1, 2016. Confirmations will be emailed to all pre-registered individuals by

May 4, 2016. If no email address is provided, hard copy confirmation will **NOT** be provided due to increased processing, handling, and mailing costs. There will be a **\$10.00** charge for those who register **on-site**. Pre-registrants receive HALF-OFF the on-site registration fee. All registration fees will be collected at EXPO Richmond entrance - **DO NOT SEND MONEY** with this form. Registration entitles attendees admission to BOTH EXPO 2016 exhibition days. Virginia Forest Products Association (VFPA) members who pre-register will **NOT** be assessed registration fees. For further information on becoming a VFPA member or regarding EXPO Richmond 2016, please call **(804) 737-5625**. Don't miss this opportunity to invest in your future.

EXPO RICHMOND 2016

Co-sponsored by Virginia Polytechnic Institute & State University Cooperative Extension and Virginia Forest Products Association

Return by April 1, 2016 to: **EXPO RICHMOND 2016 • P. O. Box 160 • Sandston, VA 23150-0160**

Please fill out completely and legibly. Incomplete or illegible forms can not be processed.

Only industry personnel should complete this form. Please copy this form for additional registrants. Spouses and children under 18 DO NOT complete this form. EXHIBITORS: Please contact Show Management for registration forms.

Your Name: _____ Nickname: _____
 Company: _____ Title: _____
 Address: _____
 City: _____ State: _____ ZIP: _____
 Telephone: _____ FAX: _____
 E-mail: _____ Country (if not USA): _____

PLEASE CHECK ALL CLASSIFICATIONS OF INTEREST: -- (You must check at least one)

- Sawmilling Logging Pallet Production/Recycling Dealer Sales Paper/Pulp
 Equipment Manufacturer Plywood/Panel Other (Please Specify): _____

Pre-registration allows entrance to EXPO 2016 at HALF-PRICE (\$5 per industry person). **On-site registration is \$10.00.** Spouses and children under 18 will be admitted free of charge. **Registration fees will be collected at EXPO 2016 entrance.**

Additional information is available at www.exporichmond.com

Educational Course Information Thursday, May 12, 2016

Educational Workshops will be held Thursday, May 12, 2016. Hosted by the Department of Sustainable Biomaterials at Virginia Tech, presenters and topics will include: Brian Bond - **Vacuum Drying Opportunities for the Wood Products Industries**; Urs Buehlmann - **The American Housing Market & its impact on the Wood Products Industry**; Henry Quesada - **Lean Logistics: Identifying & measuring waste in your supply chain**; and Mike Snow (TBA) - **American Hardwood Exports**. More information regarding these programs will be available after January 1, 2016. Registration for Educational Courses is SEPARATE from the exposition registration. **YOU MUST REGISTER FOR EACH EVENT SEPARATELY.** Information regarding the Educational Courses will be available at www.sbio.vt.edu

LENOX
WOODMASTER™
KILGORE
SAW
COMPANY

Thin Kerf
Band Saw
Blades

✓ *Check Out Our . . .*
 Quality
 Service
 Dependability
 Price

See why we are your **best** source for bandsaw blades!
Satisfaction Always Guaranteed

VISA Toll Free MasterCard
1-888-857-5153
 E-Mail: kilgoresaw@prodigy.net

Bulk Box & Crate Care

Our reinforcing corners & plates are the answer for added
 • Protection • Durability • Strength

- For New or Used items
- Apply by nail gun or hand
- 8 Sizes available
- Tough 20-gauge galvanized steel



MADE IN U.S.A.

KLUG KORNER'S
KLUG KORNER'S
KLUG KORNER'S

KLUG KORNER'S
 800-471-5060 or
 269-657-6858
 www.klugkorners.com

Actual Size Handheld Super-Size Performance

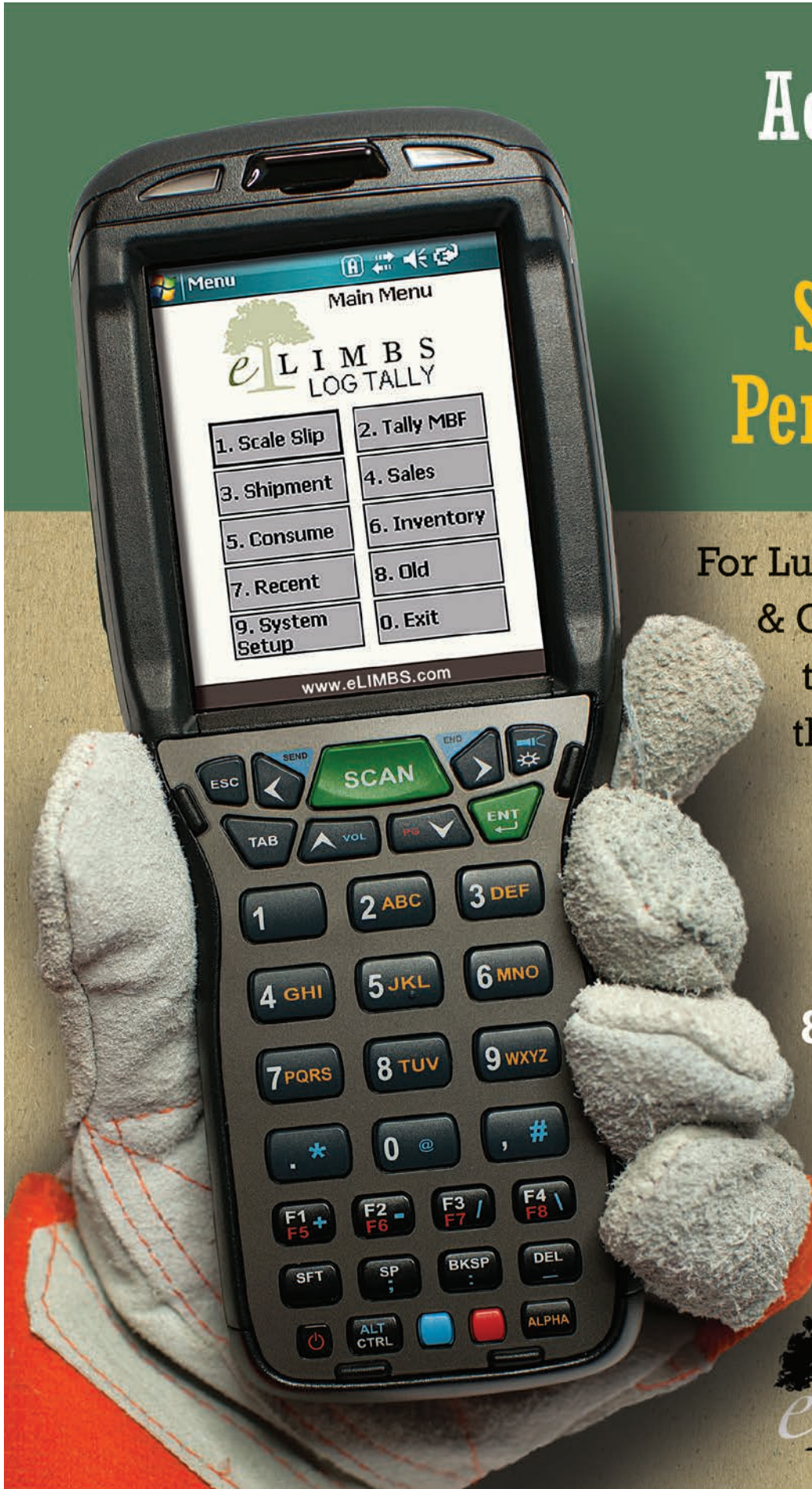

For Lumber, Logging, & Cruising, switch to the handheld that consistently out-performs all the others.

For more info and a risk-free demo call
888.520.1951
 Or go online at www.eLIMBS.com

eLIMBS
 ELECTRONIC LUMBER INVENTORY MANAGEMENT BUSINESS SYSTEMS



THE LOG STREET JOURNAL

"Your trusted authority for sawlog marketing information"

The Log Street Journal | P.O. Box 82 | Deerfield | New Hampshire 03037 | 603-463-1449 | sawlogs@outlook.com

We Specialize In Current Log Prices!

Hard & Softwood Log Prices
 Log Prices For New England, NY & PA
 Veneer Logs | Grade Logs | Pallet Logs

www.TheLogStreet.com

Celebrating 26 YEARS!
 1989 - 2015



July 1, 2015
 (Our first issue in August 1989)

Hazelthorne Pallet-Notcher Double Head

Has unscramber,
 2 - 30 HP
 3 Phase (460)
 electric motors.
 Fully automated.

Location:
 North Carolina
 Ad #: 16947

\$13,500

SAWMILL EXCHANGE
800-459-2148
www.sawmillexchange.com



LumberLine Laser



**Now Available
In Green!**

**24 month warranty
24 hour repair turnaround**

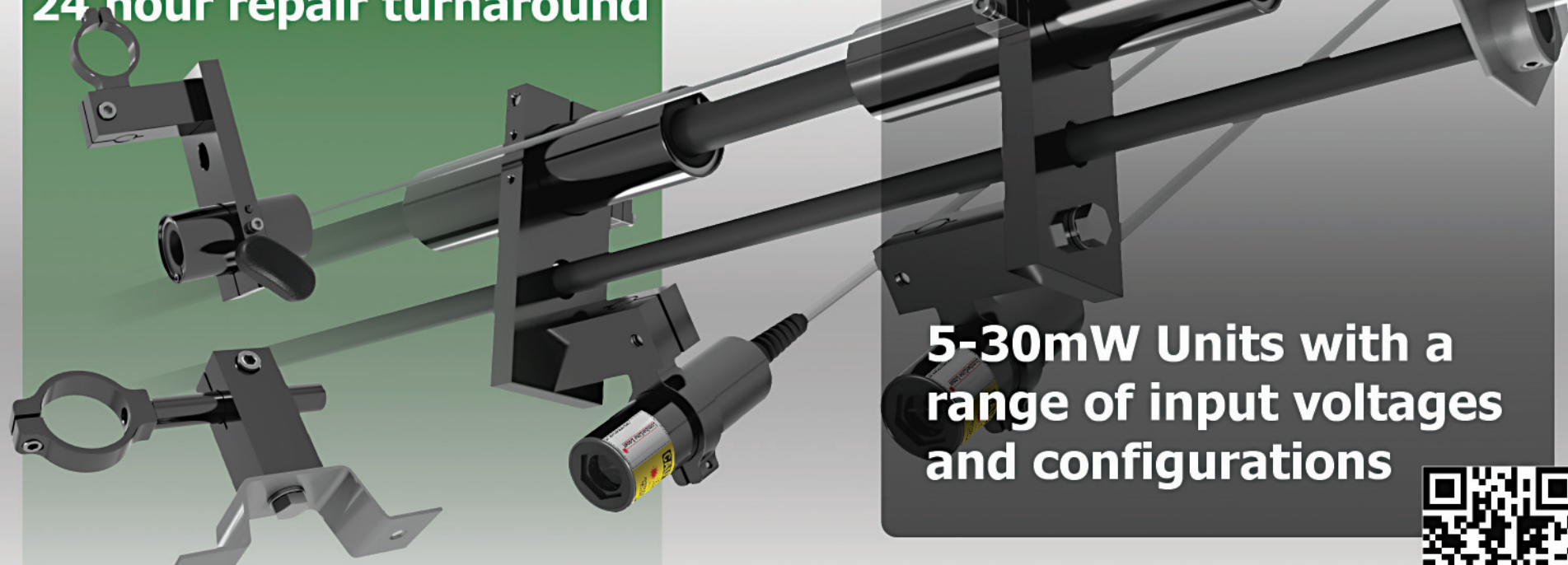

**5-30mW Units with a
range of input voltages
and configurations**



sales@lumberlinelaser.com | toll free 855-686-3077 | www.lumberlinelaser.com

Air Systems Mfg.
OF LENOIR, INC.

Let's clear the air...

by discussing your dust, smoke, fumes and vapors.

Turn-key Project Management Services:

- Trouble-shooting
- Written assessments
- Technical recommendations
- Conceptual and final design
- Manufacturing
- Custom installations
- New and reconditioned equipment
- Sales and support
- On-site maintenance

- **In Stock—Extensive Inventory of Reconditioned Equipment**
- **Maintenance Services Available for Filtration Equipment**

Check out our
new website at:
www.airsystemsmfg.com

2621 Hogan Drive
P.O.Box 1736 • Lenoir, NC 28645
(828) 757-3500 • Fax (828) 758-5178

• Dust Collection • Air Filtration • Ventilation Systems
• Custom/Standard/Reconditioned

“Authorized Dealer” for

U.S. Blades is your single source supplier of high quality knives, saws and related maintenance supplies for Sawmills & Chip Mills. With locations to serve mills throughout the Southern wood belt to the Northeast, U.S. Blades is here to support the Forest Products Industry providing new products as well as repair services.

U.S. Blades knives and saws are “Feared By Trees Everywhere.”

U.S. Blades also has field service technicians for installation and service of all Armstrong equipment with many years of Armstrong parts and equipment knowledge that will benefit our customers.

Armstrong SDSC Territory Map
Shaded areas of this map represent U.S. Blades “Authorized” selling region.

Stocking Locations for “Genuine Armstrong Parts and Equipment”

LOCATIONS AUTHORIZED TO SELL:
Florence, SC • Hampden, ME • Meridian, MS

usblades.net • 800-862-4544

SMART PRODUCTS

Is Your Answer! For Pallet Lumber Recovery and Repair Solutions.
"The Difference is Engineering"

Leasing & Financing Alternatives Available

Dismantlers

One-Man Dismantler



- 52" or 64" capacity
- 10 HP, 3-phase, electric motor standard (2200 FPM blade speed) (single phase available)
- Optional 15 HP, 3-phase (4400 FPM blade speed) electric motor available
- 18 HP gas-powered electric start on Portable Dismantler
- Gear reduction drive
- Self-contained hydraulic blade tensioning
- Low maintenance durable blade guide bearings
- Push button operated table height adjustment

Two-Man Dismantler



Pallet Dismantler System

- 64" capacity **Front Discharge** Dismantler
- Linear accumulating conveyor feeds boards easily to operator of Inclined Power Trim Saw
- Add additional dismantlers for higher production

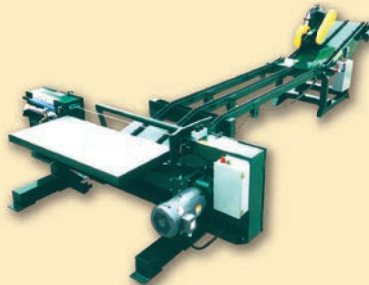

Portable Dismantler



Notchers

Double Head Notcher

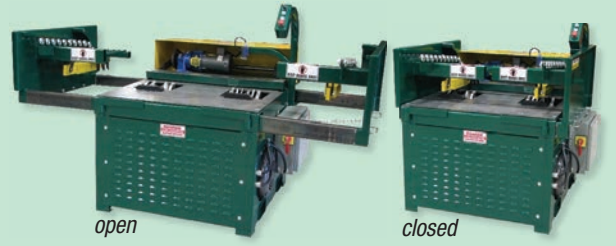

- Two, 20 HP, three (3) phase, electric motors with V-belt driven indexable notching cutterheads
- One-person operation/1,000 double notched stringers per hour
- Notches new or recycled lumber
- 48" to 96" stringer capacity standard
- 9" x 1-1/2" notches, with 18" between notches
- Quick set-up
- Continuous power feed system
- Self exhaust design (useful when notching recycled material)

Single Head Notcher

- 20 HP, three (3) phase, electric motors with V-belt driven indexable notching cutterhead
- One-man operation/500 double notched stringers per hour
- Notches new or recycled lumber
- 72" stringer capacity standard
- Quick set-up
- Continuous power feed system
- Self exhaust design (useful when notching recycled material)



Pallet Prep



- Commonly referred to as the "SmartSaw"
- Smart Saw is **multifunctional**: designed for repair (1 person) or recycling (2 person) operations of BLOCK or GMA/STRINGER pallets
- Standard 10 HP, 3-phase, electric motor with gear reduction drive
- 20' standard **M42 bi-metal** band saw blade
- Air actuated, 3-position, roller table and table extension easily positions pallet for board removal
- Machine provided with **advanced safety measures** in place, including interlock switches for perimeter guarding and cabinet doors
- Improved **canopy guarding**, with front and rear portions that move up and down with the roller table

- Specifically designed to QUICKLY (as a **1-person** operation) cut out damaged boards, including **top and bottom** deck boards, as well as **connector** and **stringer** boards
- Also designed, as a **2-person** operation, to process the disassembly / tear-down of block or stringer pallets for **INCREASED LUMBER RECOVERY**. For block style machine, includes a specially designed **Block Recovery Tool** (or BRT) that **salvages blocks** now being scrapped with other machines and processes

Double End Power Feed Trim Saw



Trim Saws

- Power Feed Trim Saws trim boards 2" thick from 18" - 60" in length on the single end, and 18" - 66" in length on the double end
- Inclined board feed and overhead saw design help eliminate board kickback
- Manual Trim Saw handles boards up to 6" thick and 6" wide
- 18" diameter nail resistant saw blades and 10 HP motors
- Heavy duty steel tube construction
- Multiple adjustable board stops on Single End and on Manual Feed Trim Saws
- Easy blade change
- Easily moved with built-in fork lift pockets
- Right saw head on double end easily adjusts to cut desired board length

Single End Power Feed Trim Saw



SMART PRODUCTS

3401 North Commerce Drive • Muncie, IN 47303
 Ph: 765.284.9545 • Fax: 765.284.7270
 website: www.smartproductsinc.com
 email: smartpro@smartproductsinc.com

800.401.0099

Every machine we build is backed by the pallet industry's most trusted and respected reputation. You can count on us being here long after the others are gone.

PORTABLE YARD SAW



This portable chain saw is for cutting logs or packages of lumber. It is available with electric drive or 20 HP gas engine with centrifugal clutch. It features manual or electric start.

HIGH SPEED CHOP SAW



L-M high speed chop saw is available in standard sizes from 48 to 84 inches in diameter. It features a heavy-duty construction frame and saw ladder.

DECK SAW



Deck saw with sawbars of up to 12 feet in length are used to cut the largest of logs, and are also used to split logs length-ways.

VERTICUT 2000-M

Hydraulic vertical guillotine length stops can eliminate the need for a double even ending unit

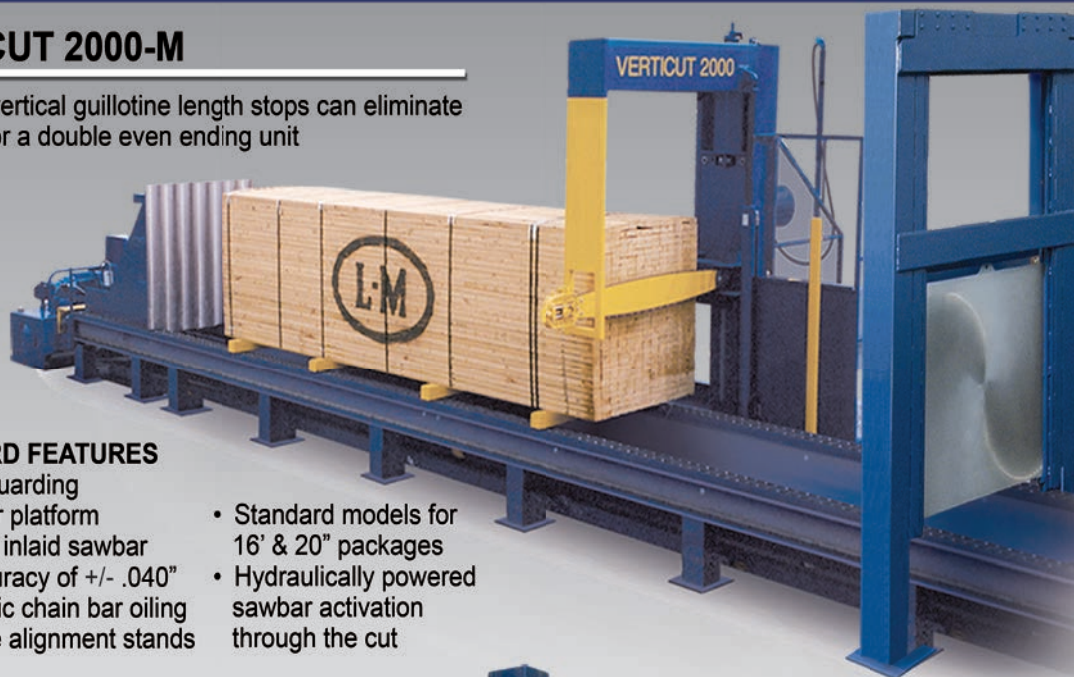

STANDARD FEATURES

- Safety guarding
- Operator platform
- "Stellite" inlaid sawbar
- Cut accuracy of +/- .040"
- Automatic chain bar oiling
- Package alignment stands
- Standard models for 16' & 20" packages
- Hydraulically powered sawbar activation through the cut

LS SYSTEM 2000 LOG SPLITTER

- Heavy duty Hydraulically powered splitter using onboard HPU.
- Adjustable travel speed using gear reduction for high torque and low power requirements.
- Splits logs up to 60" diameter by 20ft. long
- 54" vertical adjustment capability for slabs-quartering or sizing to mill capacity.



OPTIONS AVAILABLE

- Laser light saw guide
- Modular package end squeeze
- Modular even ending system
- Automatic strapping system
- Modular infeed/outfeed decks
- Electronic length measurement with digital readout
- Powered carriage positioning

The Original



L-M EQUIPMENT Company Inc.

P.O. Box 82111,
Portland, OR 97282
Phone (503) 235-3146
Fax (503) 235-3916
1-800-228-0793
www.lmequipmentusa.com



Leasing available • Call for video

Resaw Owners Can De-Dust Boards As They Saw With "Ram Jet" Replaceable Insert Guides

BAKER
U.S. Pat. #'s
6,412,380
6,889,589
6,986,300
7,325,473

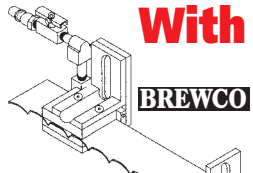
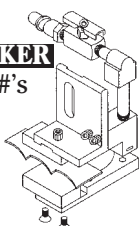

BREWCO

NEW MORGAN DESIGN!



UNIVERSAL



BREWCO PRESSURE GUIDE

We make guides for these brands and others.

Ask about our **NEW Low-Cost Phenolic Inserts!**

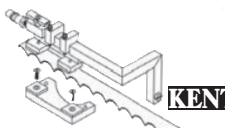

KENT

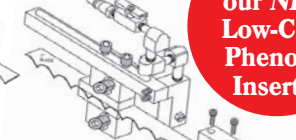

BREWER

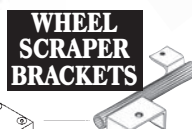

WHEEL SCRAPER BRACKETS

WHEEL SCRAPERS

1 INCH

2 INCH



FASTLINE



GO FAST



BAKER PAQ & PAQ II

www.tri-starmetalsinc.com

- **NEVER** buy another set of guides — just replace inserts!
- **NO** board deduster or hand dedusting needed
- **NO** modifications to your saw required. Just dust-free boards as you cut!

For details, call Ed
800-685-2899
or 270-281-4500



TRI-STAR METALS INC.

1415 East Parrish Ave. • Owensboro, KY 42303
FAX: 270-281-4511 E-Mail tsemi@roadrunner.com



FRICKCO, INC.

We manufacture & sell parts for Frick sawmills.

We also sell new Frickco sawmills.

Call for your nearest dealer.

740-887-3799
South Bloomingville, Ohio

DOUBLE the Life of your Bandsaw Blades in only 15 Minutes!!!



True Wheel, a patent-pending revolutionary new hand tool machine, will change the way you crown and smooth your bandsaw wheels. The True Wheel will cut your blade usage from 3 to 4 blades per day down to only one! Potentially save \$10,000 to \$20,000 in blade usage per year!

Manufactured & sold by True Wheel LLC Sales & Marketing.

For more information, contact:

931-469-5557 or 931-469-5558
www.truewheelllc.com

Need Parts to Fit Your Morgan Saws?



Sawmill Supplies & Equipment, LLC supplies parts and more!

- Board De-Dusters
- Multi-Head Trim Saws
- Military Band Groover/Notchers
- Product & Waste Conveyors

Tell us what you need.
We'll build it... the RIGHT way!

Office: 318-994-2116

www.sawmillsupplies.net

E-mail: sawmillsupplies@centurylink.net
Sarepta, LA

Sales:

Call Mona Tracy

1-855-298-8890 (toll free)

sales.universalmachinerysales@gmail.com

universalmachinerysales.net

Still Building the ORIGINAL
Low Profile Single Resaw

FOR SALE

Stacker, Pendu Model 440 HD	#1515
Auxiliary Hydraulic Power Unit, Model 1030	#1525
West Plains 4 Strand 2080 Chain Deck	#1406
West Plains Rollcase	#1398 #1405
Skate Roll Deck, 20' long 2-strand w/ stops	#1494
Rollcase 15' long x 14" wide w/pillow block bearings	#1504
Pendu Model 1600 3 Strand Green Chain	#1027
Pendu Green Chain	#1270
Lumber Transfer Deck, 26' long 2-strand C55B rooftop chain	#1498
Lumber transfer deck, 19' long 2-strand C55B rooftop chain	#1495
Lumber Hoist / De-stacker, 4,000 lb capacity	#1499
10' long, 5" wide driven Roll-case w/ 2 driven top pinch rolls, air actuated	#1496
78 Chain Deck, 3-strand 10' long w/hyd. drive	#1502

For complete details call

800-233-0471

Email: info@pendu.com

www.pendu.com

NEW HFP150 COMPACT FIREWOOD PRO From HAHN MACHINERY INC.

An affordable firewood processing attachment for those who use a lot of firewood but don't need the production capacity offered by the larger, more expensive commercial units.



Designed for use with most mid-sized and larger skid steer loaders, the new HFP150 Compact weighs 1700 lbs and requires a 15 gpm hydraulic flow.

Like its big brother, the HFP160 Firewood Pro commercial processor, the new HFP150 Compact can pick up a log up to 15" in diameter off the ground or deck, cut it into firewood lengths ranging from 12" to 20", and split those blocks into 2, 4, or 6 pieces with all functions being performed by one person from the comfort and safety of the loader's cab.

Please call **800-483-8825**
or email info@hahnmachinery.com for a free DVD, complete specifications, and pricing.

HAHN MACHINERY INC • PO BOX 220
TWO HARBORS, MN 55616

www.HahnMachinery.com



With the HFP150 Compact, the logs roll down the processor's forks into the machine's unique "shuttle trough" which carries the log up to the splitting wedge in 24" increments. Once the log is advanced to the cutting position, the trough retracts and a high speed hydraulic chainsaw cuts the firewood block. The block drops into the splitting trough and, as it's being split, the "shuttle trough" is carrying the next log segment in for cutting. The cycle is repeated until the entire log has been reduced to cut and split firewood.



THINKING AUCTION?

Call: 800-432-1922

www.wausauauctioneers.com

SALES CORP / P.O. BOX 1311 • WAUSAU, WI • 54402-1311

PH: (715) 536-1955 • (800) 432-1922

"Forest Products Specialists"

See Our New Equipment Website

www.kittrellsawmillbrokers.com

Request Our Award-Winning Newsletter with Equipment listings, Wanted Equipment, Appraisal information...and much more
Join our network and get your copy today!

Call us today (931) 797-6284 TO GAIN ACCESS



Your Most Reliable Source for New, Used & Customized Machinery. Call Mona Tracy Today!



The **RUN-A-GADE** Bandsaw Pallet Disassembly System



TRIO
3-Head

BANDSAW DISASSEMBLERS!

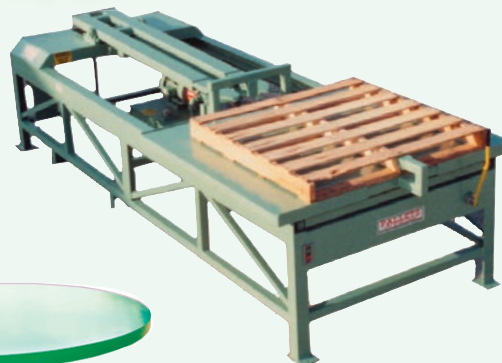

SOLO
Single Head

DISC TYPE DISASSEMBLERS!



MARK I
Bandsaw Disassembler
Make it a complete system with a round table



Manual Chop Saw

LUMBER SAVERS!



TRIM TRAC
End Trim Saw



**High Speed Pop-Up
Cut-Off Saw**



SN20 Automatic Notcher

NOTCHERS!



BLOWERS!



UNIVERSAL
MACHINERY SALES, INC.

Call Mona Tracy

Toll Free 1-855-298-8890
or **812-298-8090**



- Corner Rounder
- Chamfer
- Unstubber
- Pallet Sizer
- Round Tables
- Specialty Machinery

www: universalmachinerysales.net

E-Mail: sales.universalmachinerysales@gmail.com

Leasing & Financing Available

The Most Innovative Equipment is a Phone Call Away..



**NEW
4-Head
Design!**

Low Profile BAND RESAWS

Single & Multi-Head Models
Available with or without return
Hands-free return eliminates one operator
Save labor - Save money!



NEW Multi-Head TRIM SAW

2, 3, 4 or 5 head models
Adjustable heads with variable speed, chain feed
drive motor with starter
20" x 40-tooth carbide blades
Quick change adjustable to length

NEW! ANGLE CHOP SAW

Cuts 0° to 45° on a 2x8
and 0° to 40° on a 2x10
Fast Cycle
Easy to set up and operate
Guarded blade for safety



Robo Chop UPCUT SAW

Automatic push feeder,
30,000 B. F./shift. Stacks
boards 5 high & up to 16
wide. Up to 16 ft lengths



Military BAND NOTCHER

Fully Adjustable notch-length of board
Option: Double groove notch and 14" blade
to cut board into two strips



Hopper-Feed BLOCK SAW

Cuts 2x4 & 4x4 blocks from 24" drops
30 hp, 3-phase motor/starter



Self Dumping STEEL HOPPERS



REPAIR BARS!

Call for
Pricing!



STAKE MACHINERY

SCISSOR LIFT



2,000 lbs. to 8,000 lbs. per your specifications

Every Reputable Wide Band Supplier Offers...

- ✓ High Quality Swedish Steel
- ✓ 3" - 8" Band Width
- ✓ 16 to 20 Gage
- ✓ Double Cut Options
- ✓ Choice of Swage or Stellite

BUT ONLY THE **WOLVERINE** BY MENOMINEE SAW GUARANTEES...

- Cutting Edge Plasma Welds
- The Industry's Highest Cutting Capacity Band Saw
- Quick Delivery from our **HUGE** Inventory
- Fast Sharpening & Exchange Program to Keep YOU Running
- Competitive Pricing

And **ONLY** Menominee Gives You Everything You Need in a Wide Band Saw - *Plus* Expert Service from the Industry's Most Knowledgeable Staff.

Got a Wide Band Problem?
Call Menominee Saw Today and You'll Learn Why More Mills Trust the Pros!



TOLL FREE
1-800-582-0470

WWW.MENOMINEESAW.COM

Email: info@menomineesaw.com

WOOD MOISTURE METER



Especially suited for pallet lumber to avoid mold.

- wide range up to 45%
- an easy-to-read, digital display
- and a not-to-miss introductory special.



Convenient to use. Built-in calibration. Lignomat's Reliable and Accurate Measuring Technology.

Lignomat USA --- 800-227-2105
PO Box 30145, Portland OR 97294
Tel: 503-257-8957, FAX: 503-255-1430 USA
www.lignomat.com E-mail: sales@lignomat.com

Over 12,000 Edgers Built And Still Going Strong

Meadows Mills' acquisition of Miner Edger means we have more edger building experience and more edgers in operation worldwide than anyone else. So trust your next edger investment to the real experts. We've been building better sawmill equipment since 1902!

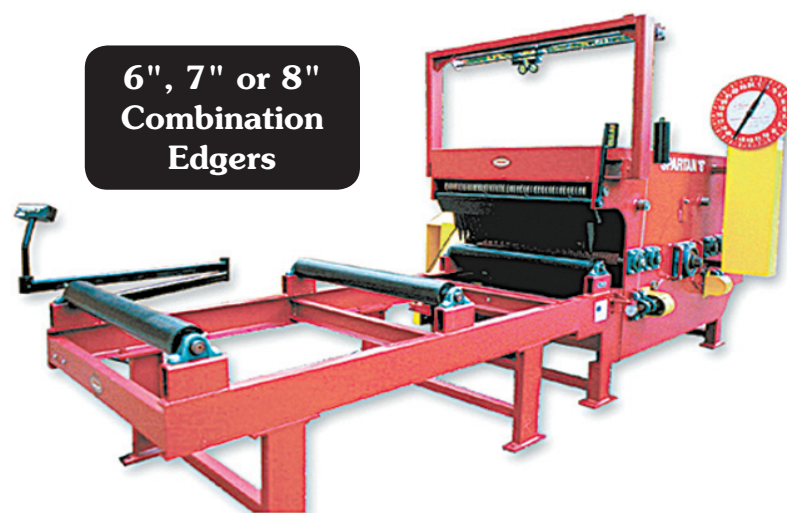

- Available with 6", 7", and 8 1/2" depth of cut
- Frame widths available in 36", 42", or 48"
- Solid steel side plates with door for easy saw changes
- Made in USA
- Call Meadows Mills and let us design a combination edger to improve your efficiency and profit!

MEADOWS MILLS, INC.
800-626-2282

www.meadowsmills.com • e-mail: sales@meadowsmills.com



Rotochopper EC 366

Call today for more information

PALLET MACHINERY GROUP

540-644-9220
or visit www.palletmachinery.com

E-mail: info@palletmachinery.com

The Leader In Chain Bar Repairing Since 1961

🎉 : Celebrating 50 Years : 🎉

Cut off bars for bundled lumber and cut off applications
We repair all types of bars and offer custom manufactured bars for all aspects of the wood products industry.



CALL TOLL FREE
1-877-SAW BARS (729-2277)
or **503-774-4266** www.chainbar.com

Email: chainbar@comcast.net

BILL DAVENPORT • 5425 SE Johnson Creek Blvd. • Portland, Oregon 97222



PHASE CONVERTERS Since 1965

Run your 3-phase machines from 1-phase utility power lines. Run these and more:

- ✓ Dust Collectors
- ✓ Air Compressors
- ✓ Sanders
- ✓ Grinders
- ✓ Shapers
- ✓ Routers
- ✓ Saws

Economical source of three-phase power



PHASE-A-MATIC

Call or go online today:

www.phase-a-matic.com 1-800-962-6976

Parts & Repairs For Your Nailing Machines...
 Pallet, Wooden Box, Cable Reel & Tackless Nailers
 Specializing in FMC, Doig
 — even older Morgan & Gage machines!
F.W. Morse / PVI Co. • 518-747-2017
 www.nailingmachineparts.com
 e-mail: morgangageparts@gmail.com

New Inserted Tooth for Cutoff Saws
B-ITCO
 • Slasher Saw Operations
 • Log Merchandising
 • Firewood Processing
Bartlett's Saw Service & Supply
800-566-0319

HUGE INVENTORY- FORKS

ATTACHMENTS WORLDWIDE AIM

We offer forks, rakes, buckets, thumbs, grapples, and much more!

Nationwide Toll Free Ohio: (800) 803-3365 www.aimattachments.com

THICK	WIDE	LONG	HIGH
2"	5"	48"	48"
2"	5"	60"	48"
2"	6"	48"	48"
2.5"	6"	48"	48"
2.5"	6"	60"	48"
2.5"	6"	72"	48"
3"	7"	60"	48"
3"	7"	72"	48"
3"	7"	96"	48"
3.5"	8"	96"	60"
3.5"	8"	108"	60"

Available for quick shipment call for pricing!

Ask about our Grapples!

EFFICIENTLY REMOVE BY-PRODUCT WITH PENDU BLOWERS & BARK CONVEYORS

BLOWERS

- 4 and 6 blade fan designs
- Quality steel components
- 18", 26", and 42" models
- Alloy steel shafts, heavy-duty ball bearings
- Quiet operation



BARK CONVEYORS

- Easily move secondary products: bark, sawdust, shavings, etc.
- Straight line or any combination of degree angles
- Can be elevated up to 35° for material depositing into trucks, hoppers, or piles



Stackers Trim Saws Gang Saws Scragg Mills Edgers
800.233.0471 717.354.4348 www.Pendu.com

The Name Says It All... GoFast Manufacturing!
Under New Ownership
Simple, Strong, Affordable and FAST!

Remove Dust FAST for LESS with the NEWLY Redesigned GoFast DeDuster

- Easily adjust board heights in less than a minute
- Safer and Smoother Operation
- Adjustable Fences for 2"-10" Material — **NOW STANDARD**
- Improved Board Knocker System — **NOW STANDARD**
- Improved Hydraulic Systems

Videos Available!

GoFast Band Resaws are Low Profile, Single and Multi-Head for Pallet Lumber, Slab Recovery, Fence Boards **EVEN** Siding & Shingles! Need Maximum Production with Minimum Investment?

- Gas or Electric Power — **STANDARD**
- Quick 1/8" – 6" Thickness Adjustment — **STANDARD**
- Variable feed speed from 0-150 fpm — **STANDARD**
- Quick Adjust Blade Tracking — **STANDARD**
- Low Profile Self Contained Unit
- Ships Complete and Ready to Saw

Better By Design, Sturdy Where it Counts, Priced to Make You More Profitable – That's the GoFast Way! Call Today

GOFAST MANUFACTURING

Be Sure to Check Out Our New Website!
www.gofastmfg.com
1-800-854-7439

Under New Ownership E-Mail: sales@gofastmfg.com • Fax: 920-227-1961

We Have New and Refurbished Units Available

Resaws • DeDusters • Chopsaws • Grade Systems • Parts

Cut Your Blade Costs – Keep Your Profits!



The Pallet Hawg Bandsaw Dismantler will pay for itself in no time in blade savings alone!

- One or Two Man Operation or Pallet Prep Saw
- The most versatile Pallet Dismantler Available
- Gear Reduction Drive for Long Blade Life
- Pneumatic Table Travels 5 1/4" to Allow for Easy Stringer, Block, or Deckboard Removal

NEW Power Feed Trim Saw

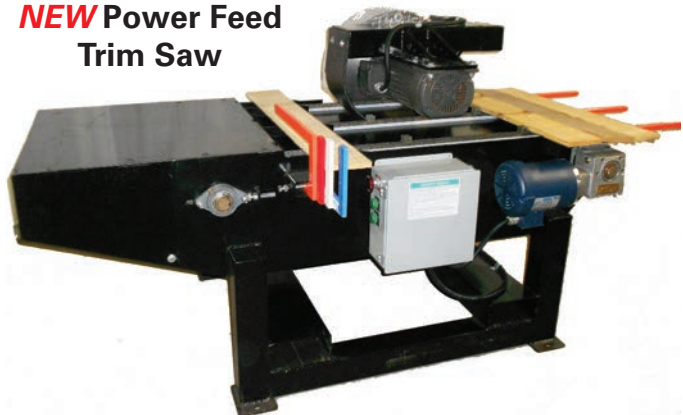

- Up to 12,000 trimmed boards per 8-hour shift!
- 4 adjustable board stops, set from 16" to 66" long
- No belts or pulleys to wear out or replace
- Handles stringer & deck boards up to 2 1/2" thick

NEW Pallet Hawg Up-cut Saw



- Trims both new & recycled lumber
- 10 HP, 18" blade
- 5" x 6" capacity

Change is good.

Get more blade life AND a smoother, more efficient operation.

Call Brad or Kent @
1-800-348-0703

www.noblemachine.com

NOBLE MACHINERY CO. INC.



Timber Harvester Modular Grade Resaw System - SAVE BIG!



LPS EQUIPMENT & ACQUISITION CO. **800-598-3651**
731-986-4351 | sales@lps-inc.com **WWW.LPS-INC.COM**

Everyone has surplus equipment that could be earning CASH.

Our equipment brokering service is the way to go! Let us handle the hassles and headaches for you.

You can benefit like others... Call us today to get started.



Check Us Out!

Call **Jacqueline Kittrell**
931-698-3342

www.kittrellsawmillbrokers.com

Turn Your Surplus Equipment Into

CASH

We pay top dollar for good used equipment.

Go to our website for an up-to-date listing or call us at

800-241-8983



Ben Jones Machinery
Div. of Dickert Enterprises, Inc.
Industry's Most Trusted Source

UPDATED DAILY!
www.benjones.com
E-Mail: sales@benjones.com

When You Buy Your Circular Saws From B.H. Payne – You've Bought The Best . . . We Guarantee It!

Here's What You Get With EVERY B.H. Payne Saw –

- Saws manufactured from only the Highest Quality Nickel Alloy Steel
- Each Saw Milled With State-Of-The-Art Precision CNC Milling Machine
- We Tension Your Saw to Your RPM BEFORE Leaving Our Factory
- Complete Guarantee of Your Satisfaction

We Are Hanchett Distributors

We Manufacture & Sell Inserted Tooth Headsaws, Solid Tooth Saws, Inserted Tooth Cutoff Saws, Carbide Saws & Wide Band Saws. We Also Stock And Sell Bits & Shanks, Carbide Tips, Diamond Wheels, Knife Grinding Wheels, Saw Gumming Wheels, Knives, Babbitt & Babbitt Pots, "Lubie" Lubricants, Machine Parts for Various Filing Room Machines & More!

B.H. PAYNE & COMPANY, INC.

P.O. BOX 90608, East Point, GA 30364
404-761-8711 FAX 404-761-5398

"Traditional Quality Combined With Today's Technology"

Call 800-752-0627

Make Sure To Ask For Our Free, Complete Saw Catalog

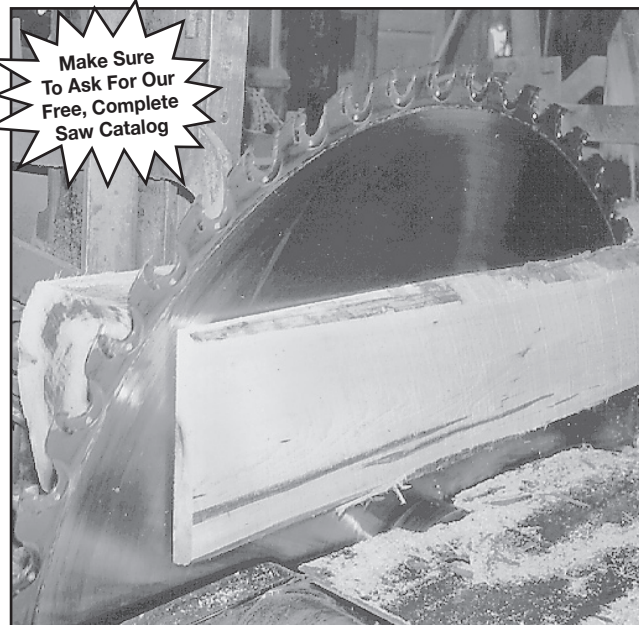

www.paynesaws.com

SAVE 25% Or More on NEW CHIP BINS!



Crown Machinery's New Line of Chip Bins Are Designed To Fit Your Application — **Chips, Dust, Shavings or Any Bulk Material.**



With the growing demand for bulk storage and the dwindling supply of used bins, Crown Machinery's line of bins blows the competitors away — in **Reliability, Design and Cost!**

Our Bins are built to last. The most affordable on the market!



Crown-Hildebrand Kilns

Hildebrand is one of the world's leaders in drying technology. Crown Machinery is now a mass distributor of Hildebrand Dry Kilns. If you're not drying, you're losing money!

Dried lumber is worth more. We can show you how...



CROWN MACHINERY

SCOTTSBORO, AL

256-218-3045

Fax: 256-218-3062

Sales, Service, Engineering, Installation & Removal of Equipment

www.CrownMachinery.us

harvey@crownmachinery.us

2 "TIPS" FOR MONTGOMERY HOG OWNERS!!

Inventors of the "SHANKLESS" 2-PIECE HARDFACED HAMMERS Bring You 2 TIME-PROVEN MAINTENANCE SOLUTIONS

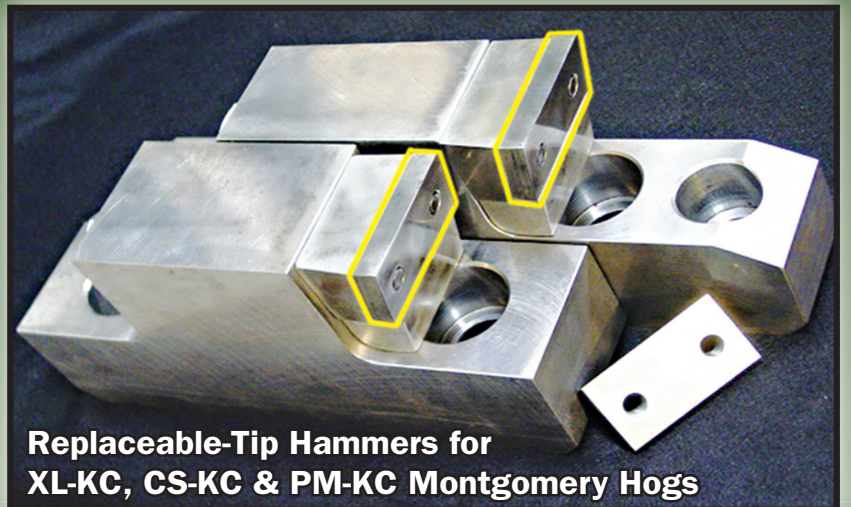

Replaceable-Tip Hammers for XL-KC, CS-KC & PM-KC Montgomery Hogs



Available in Overlapping-Cut & Hi-Rake Style, Too!

Replaceable-Tip Hammers and Lower Teeth for Montgomery Hogs

PRECISION-MACHINED OUT OF OUR SPECIAL MATERIALS, THESE INSERTS WEAR LIKE HARDFACED PARTS!!

- PARTS FIT - FIRST TIME, EVERY TIME!
- No more shipping parts back and forth to be rebuilt!
- No more waiting for parts to get back to you!
- No messy hardfacing welding and grinding of hammers!
- No more cracking/breaking off of hardfacing!
- You can "REBUILD" HAMMERS IN MINUTES!

Need Other Parts, Screens or Rebuilds? Call the experts with over 40 years experience!



ELLISON SALES, INC.

TOLL-FREE: 1-888-244-0161

FAX: 503-293-0816

EMAIL: sales@ellisonsales.com • WEBSITE: www.ellisonsales.com

Good Used Equipment — Priced To Sell!



\$4,900

**Morgan
Single Head Resaw
Very Good Condition!**



\$7,900

**Cornell Trim Saw
w/Hydraulic Pack and Joy Stick,
Needs Some Repair Work**

Call Wayne 803-534-0404



**NEW PRECISION
6x6 Chip Screen**

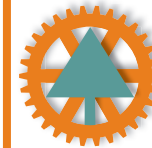

Ben Jones Machinery

Div. of Dickert Enterprises, Inc.

Industry's Most Trusted Source

800-241-8983

See more equipment at
www.benjones.com

**STAKE POINTERS
FOR SALE**
Keystone Machinery Corp.
Ephrata, Pennsylvania
717-859-4977

**2016
NORTHEASTERN
FOREST
PRODUCTS
EQUIPMENT
EXPO**
ESSEX JCT., VERMONT
MAY 6 & 7, 2016

THE AWARD-WINNING NORTHEASTERN FOREST PRODUCTS EQUIPMENT EXPOSITION

Where serious business is conducted

Thousands of hard working people plan to get together in Essex Junction, Vermont this May to conduct serious business. The Loggers' Expo is the largest and best exposition of supplies and services, heavy equipment and trucks – for loggers and land clearers, tree care professionals and firewood dealers, sawmillers and landowners. If you're serious about your business – you need to attend or exhibit in Essex Junction, Vermont.

2016 Loggers' Expo May 6-7, 2016, Champlain Valley Exposition Essex Junction, Vermont

For information about attending or exhibiting at the 2016 Loggers' Expo, visit us online at www.northernlogger.com or call toll-free 800-318-7561 or 315-369-3078.

Redefining Pallet Repair

- Boost Production
- Reduce Labor
- Improve Ergonomics and Quality
- Improve Product Flow and Handling Efficiency
- Reduce Forklift Usage and Cost

Stackers
Conveyors
Dismantlers

Trim Saws
Band Saws
Splicers

Platers
Destackers
Stack Tipplers

and Much More

CONTACT US TODAY TO FIND OUT HOW WE CAN
ADVANCE YOUR BUSINESS THROUGH AUTOMATION

844-892-2322 PRSGroupInc.com

PRECISION-BALANCED HOG ROTORS

ELLISON SALES, INC.
Toll-Free: 888-244-0161
dan@ellisonsales.com

BANDSAW BLADES

We have the most popular sizes in stock & ready to ship from major manufacturers, including...

LENOX  **Wood-Mizer Blades**
Your Leader in Blade Technology.

Welded to your lengths!

We also offer expert Sharpening Services, plus...

Gang • Edger • Scragg
Trim • Split • Strob

...and just about any Custom Saws you need to keep you cutting longer...for less!

Call Marvin Miller for a quote
231-924-5953 (fax) 231-924-6166

In Stock — READY To Ship

Ask About **FREE Shipping!**



MIDWEST SHARPENING SERVICE

Save \$\$ On Lumber Handling

We recently completed a large job and took several items in on trade.

Save money now while you can!

- (3) Leaf Chain Tilt Hoists
- Lumber Unscrambler with built in even-end rollers
- Froedge two-saw trimmer, one movable blade, electric, includes controls, powered even-end rolls, elevated scrap belt
- HMC two-saw trimmer, one movable blade, electric, includes controls, elevated scrap belt
- Chain Deck 29' x 11', 4-strand, electric
- Chain Deck 33' x 11' 4 strand, electric
- Chain Deck 20' x 11', 4-strand, no power
- Live roll-case 18' x 33" with built in transfer chain
- Live Roll-case, never been used 24" x 16'
- Stacking stick transfer chain for 6' stick racks, 40' long, two-strand
- Lawson stacker for parts
- Breakdown hoist for packaged lumber, includes integrated infeed deck
- (3) Hydraulic power packs for Newman Planer



888-868-5891

Crosscut Unit Saws

See in action at www.ptmi.net

Quick, Accurate Processing
--- Low Labor!



NOW BUYING

Used Pallet and Pallet Recycling Machinery.

1-800-348-0703

 NOBLE MACHINERY CO. INC.

Ramp Up Your Firewood Business!



Model 2040xp2 – The Premier High Volume Firewood Processor



Model 1610EZ - Joystick control, gas or diesel, live deck or log lift, ultra mobile with integrated conveyor.



The Log Buster!

- Quarter Oversize Logs for further processing...
- 115 HP engine
 - Over 100 tons of brute splitting force.
 - Chip, Grind, Pulp, Firewood, Biomass & More!



Prentice, WI 54556-0170 USA • 800-243-5438 • e-mail: sales@multitekinc.com • www.multitekinc.com

You need sensors that work reliably in areas with...



Pantron Sensors

- Blast through steam, sawdust, & fog
- Not affected by vibration or sunlight
- Through-beam range up to 230 feet
- Eliminates need for compressed air



Perfect for Sawmills!



Call toll-free or visit us on the web
 1-800-211-9468
 pantron.com



Why Rely on U.S. Blades for Your Saws, Blades, Knives, Filing Room Supplies and More?

With 5 technologically advanced service centers, 15 delivery trucks and over 75,000 square feet of warehouse and factory space, U.S. Blades consistently delivers the leading edge to its customers.

From the green end to the planer mill, we are your single source supplier of high quality knives, saws, bandsaw blades and related maintenance supplies for sawmills.

Authorized Dealer For
SIMONDS INTERNATIONAL
 Armstrong

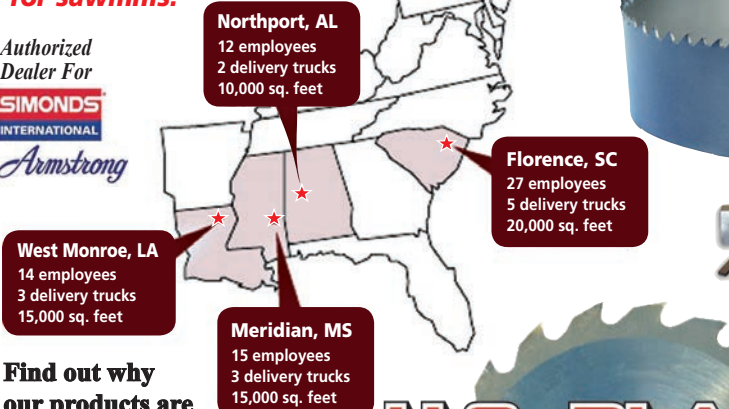

Find out why our products are "Feared by Trees Everywhere!"

U.S. BLADES

800-862-4544 • www.usblades.net

STRAIGHT TALK & SAWMILLS That's What You Get at Sawmill Exchange!

OVER 800 LISTINGS!

Band or Circular Sawmills, Portable or Stationary, Manual or Auto, Hobbyist to Professional Models.

Plus, the Support Equipment to "Make Your Dream Mill a Reality."

Like Resaws, Edgers, Planers, Dry Kilns, Chippers, Loaders, Firewood Processors and More!



2014 Timberking 2200

Fully hydraulic.
 49 HP Kubota diesel engine.
 Includes debarker & computer networks and about 28 brand new blades.
 Still under warranty. < 50 hours.
 Mill is always under cover.

\$39,000

Location: Missouri
 Ad#: 16997

Call Today to Sell Your Mill or Receive Current Inventory Listings! Or Go Online —

www.sawmillexchange.com

SAWMILL EXCHANGE

800-459-2148

713-729-6455 (713-SAWMILL) • Fax 205-453-4262

New Meadows Carriages To Fit ANY Sawmill

112 Years of Experience
Makes Meadows The Perfect Choice To Design *Your* Next Carriage



Meadows Center Dogging Carriage/Center Dogging Headblock

- Carriage frame lengths from 10 feet and up. Openings from 33" to 44"
- Center or side mounted hydraulic board dogs with push button controls.
- Hydraulic "on-the-headblock" turners available, push button controls.
- Setworks with hydraulic drive, electric controls & rotary encoder or linear temposonic rod.
- Carriage wheels from 6" to 10" diameter for "T" or hex rail systems.
- Hydrostatic carriage feeds and hydraulic power sources also available.

MEADOWS MILLS, INC.
800-626-2282



www.meadowsmills.com • e-mail: sales@meadowsmills.com

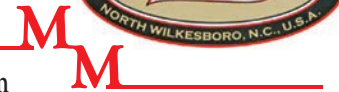

INDIANA HARDWOOD LUMBERMEN'S ASSOCIATION

presents the



**2016 IHLA
 Convention &
 Exposition**

■ You're invited to be a part of the largest convention & trade show of it's kind in the Midwest with over 900 attendees & 80 exhibitors.

■ Meet & network with sawmill owners, secondary manufacturers, buyers, sellers, loggers, foresters landowners, & government partners.

FEBRUARY 2-4, 2016

Indianapolis Marriott Downtown

Sponsored by: Pennsylvania & Indiana Lumbermens Mutual Ins. Co.

Visit us online at www.ihla.org
 For attendee information please contact:

Denice Helmbrecht 317-875-3660 - deniceh@ihla.org OR
 Ashley Tandy 317-875-3660 - ashleyt@ihla.org

DOORS OPENING AT PRS GROUP'S NEW SHOWROOM

JACKSONVILLE, ILLINOIS

— PRS Group Inc., based in Illinois will open the doors to their new showroom in their Jacksonville facility on February 15th, 2016. This showroom will host many different types of PRS machinery for demonstration as well as the CAPE Mach 2 nailing machine. Customers are encouraged to pre-schedule an appointment with PRS to visit the showroom to see these machines in action, and to meet face to face with PRS representatives to discuss production solutions for their needs.

PRS Group Inc., founded in 1989 specializes in manufacturing and engineering excellence. They manufacture a wide range of machines for the pallet sortation, repair, and recycling processes. For more information, visit www.prsgroupinc.com. PRS Group also represents Mecanica Cape, a Spain based company that focuses on creating innovative and reliable pallet machinery. PRS partnered with CAPE earlier this year representing their product lines throughout the US and Canada. To learn more about CAPE, visit their website at www.cape.es.

To contact PRS about scheduling an appointment

call the office at (217) 291-0009
 or toll free at (866) 546-8864
 or send an email to Jeff Williams
 at jwilliams@prsgroupinc.com.





HUGE 7 DAY AUCTION

42ND ANNUAL KISSIMMEE FLORIDA FEBRUARY 8-15 2016



-Day 1-

**Monday, Feb. 8,
2016**

Motor Graders, Asphalt Rollers, Asphalt Pavers, Asphalt Distributors, Compactors, Sweepers, Brooms, Vacuum Trucks, Soil Stabilizers, Roto Mills, Mixer Trucks, Concrete Equipment, Misc.

-Day 2-

**Tuesday, Feb. 9,
2016**

Rubber Tired Loaders, Rubber Tired Loader Backhoes, Skid Steer Loaders, Attachments, Misc.

-Day 3-

**Wednesday, Feb.
10, 2016**

Crawler Tractors, Crawler Loaders, Dirt Compactors, Motor Scrapers, Water Wagons, Off Highway Water Trucks, Attachments, Generators, Electric Motors, Power Units, Engines, Misc.

-Day 4-

**Thursday, Feb. 11,
2016**

Hydraulic Excavators, Attachments, Off Highway End Dumps, Dumpers, Forklifts, Engines, Misc.

-Day 5-

**Friday, Feb. 12,
2016**

Rough Terrain Cranes, Truck Cranes, Crawler Cranes, Pumps, Manlifts, Pile Driving Equipment, Marine Equipment, Crushing & Screening, Boom Trucks, Bucket Trucks, Fuel & Lube Trucks, Water Trucks, Mechanics Trucks, Air Compressors, Welders, Light Plants, Misc.

-Day 6-

**Saturday, Feb. 13,
2016**

Farm Tractors & Implements, Mowers, Forestry, Track Drills, Boring Equipment, Trenchers, Digger Dericks, Flatbed Trucks, Automobiles, Vans, Pickups, Specialty Items, Rollbacks, Garbage Trucks, Cabs & Chassis, Misc. Trucks, Buses, Misc.

-Day 7-

**Sunday, Feb. 15,
2016**

Tri-Axle, Tandem & Single Axle Dump Trucks, Flatbed Dump Trucks, Truck Tractors, Lowboy, Dropdeck, Dump and Flatbed Trailers, Trailers



**Visit our website to bid online!
Call to Consign Quality Equipment**

(419) 865-3990

1670 Commerce Rd. Holland, OH 43528

www.yoderandfrey.com

Low Profile Band Resawing

Raising the Bar – Lowering the Cost!

- ✿ - HUGE Labor Savers
- ✿ - Cant returned **HANDS FREE** to the operator
- ✿ - Simple, compact design – return is built into the machine, all as one unit
- ✿ - 24/7 Support & Service
- ✿ - Easier to operate & maintain
- ✿ - Most economical on the market!

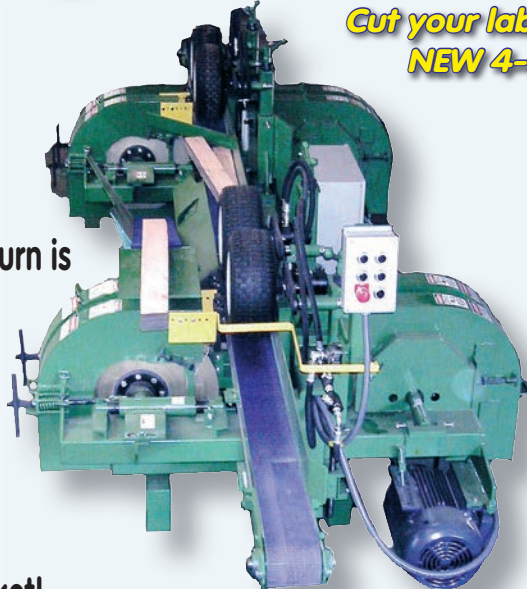

Cut your labor costs with our NEW 4-Head model.

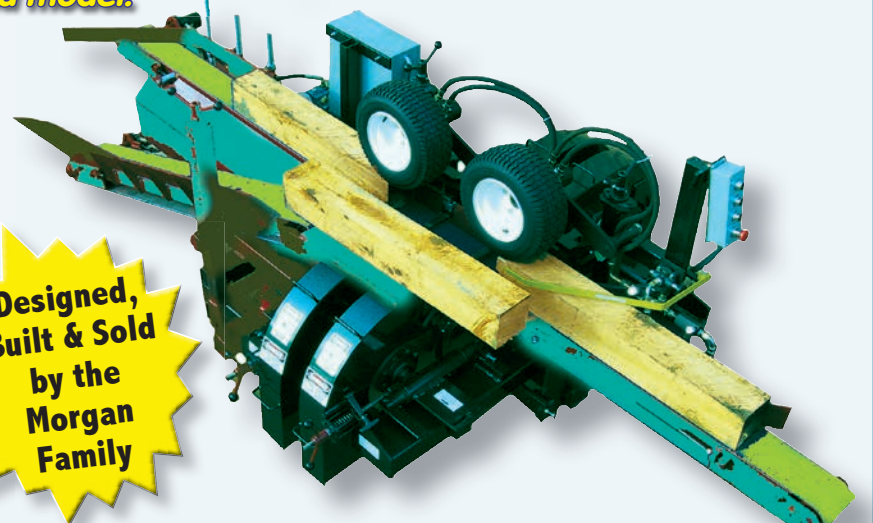

Designed, Built & Sold by the Morgan Family

Only 2 operators needed!

1, 2, 3 & 4-Head Models

Call Our Team Today to Talk About Your Resawing Needs!

Multi-Head Resaws DBA Morgan Wood of LA, LLC
Pat Ortiz-Morgan
1-318-617-2732 or 1-318-469-5077
info@morganwoodofla.com

Sales:
Call Mona Tracy
1-855-298-8890 (toll free)
sales.universalmachinerysales@gmail.com

Baker Products and KASCO WoodMaxx Blades Join Forces to Win Shoot-Out



A cold and rainy October day did not dampen Baker Products' spirits (or performance) in this year's Sawmill Shoot-Out at the Paul Bunyan show in Cambridge, Ohio. The team of sawyer Hank Somer and tailman Clay Hedrick operated a Baker Blue Streak 3665D mill and a KASCO Maxx-7 blade to out-shoot the completion at this year's event. Baker Products and KASCO blades earned first place honors in the hydraulic mill category by sawing their way to an impressive production rate of 1,273 BF/hr and a production overrun of 1.07.

For the competition Hank Somer brought his new Baker Blue Streak Model 3665D from New Hampshire where he runs a one-man sawmill business. The Baker Blue Streak Model 3665D is a 65 HP Cummins diesel powered band mill that offers a cutting capacity of 36 in. x 20 ft. (D x L). His blade of choice was KASCO's Maxx-7 blade. KASCO's high-performance Maxx-7 blade features an aggressive 7-degree hook angle and 7/8" tooth spacing. Hank runs this blade on a daily basis and claims he hasn't found any other that outperforms the Maxx-7 blade from KASCO.

Ask your distributor for KASCO WoodMaxx blades and their new Maxx-7 profile or visit www.woodmaxxblades.com. Contact Baker Products at **1-800-548-6914** or visit www.bakerproducts.net for more information on their complete line of equipment.

LOST CREEK WOOD PRODUCTS SAWMILL AUCTION

LOCATION: 506 Oak Drive • Mifflintown, PA 17059

DIRECTION: From Rt 322 in Mifflintown take Rt 35 five miles to Tennis Park Rd and turn left. Go 1 mile to 2nd stop sign and turn right on Sunset Drive. Go 1/2 mile to Oak Drive and turn left. Go 3/4 mile to Lost Creek Wood Products - Same location as J&M Pallet.

FRIDAY JANUARY 15, 2016 @ 10:00 AM

FORKLIFT & DIESELS: JCB 940 forklift - 8000 lb lift w/ only 560 original hours - Pin JCB94004V02364030 type 940-4T4, 8'x4'x3' scoop for forklift, Detroit 671 diesel, Detroit 671 diesel w/ hyd's, Detroit 471 diesel.

SAWMILL & RELATED ITEMS: 4 headblock Frick O sawmill w/ air & hyd carriage in good cond., 3 blade Edminston 6"x36" edger, West Salem hogg w/ vibrating conveyor, Reckart log turner, 3 strand 16' log deck, mud saw w/ hyd. motor, 2 Pendu 26" blowers, 40' Tulsagear green chain w/ hyd. motor, 22"x12' hyd belt conveyor, 37' Zimmerman elevator, hyd pumps on husk & tank, 2 - 10' rolls w/ 8" rolls, 2 - 10' rolls w/ 4" rolls, light set rolls, 4 dumpsters - two 7' one 5' and one 7' without ends, 11 lumber carts, 500 gal fuel tank, 2 - 500 gal air tanks.

SMALL TOOLS: Log medal detector, jockey grinder, banding cart & tools, Harris torch & tanks & cart, Campbell & Housfield torch set, Husquvarna 365 & 555 chain saws, Mix Rite Tiffen lumber sprayer, drill press w/ air motor, 80 hole bolt bin, 3 stack 13 drawer Craftsman tool box, air impact wrench, air grinder & drill & screwdrivers, pulley pullers, flex couplers, grease guns, sprockets, shelves, pulleys, pipe wrenches, adjustable wrenches, heavy jumper cables and lots more misc tools.

2 SKID BUILDINGS: New 10'x16 lunchroom skid building w/ 4' porch - insulated & drywalled, 10'x16' office building on skids w/ T111 siding - insulated w/ paneling and 4' porch.

TERMS: Cash or Check w/ ID. Out of state checks w/ bank credit letter.

SALE ORDER: Starting w/ smalls and finish w/ saw mill and loader. Approx a 3 hour sale.

LUNCH STAND ON GROUNDS



AUCTIONEERS:

ANDY RABER AUCTIONS LLC.
 5345 TR 118 • Baltic, Oh 43804
330-893-2604
 PA LIC# AU005157

DANIEL WEAVER
 330-231-8865
 PA LIC# AU005695
 SALE DAY PHONE: 330-473-3994

For more pictures go to Auction Zip ID# 22244



OWNERS:

MR. & MRS. DAVID YODER
 1378 Free Spring Church Rd
 Mifflintown, PA 17059

JAMES G. MURPHY CO. NO MINIMUMS - NO RESERVES



PUBLIC AUCTION



THE FORMER SIMPSON MILL IN DAYTON
9AM - TUESDAY - FEBRUARY 16, 2016



AUCTION TO INCLUDE: (2) LINDEN STEP FEEDERS - UNITED HYDRAULICS
REMOTE LOG LOADER - (1) KOCKUMS 66" CUT OFF SAW & (8) KOCKUMS 44" CUT OFF
SAWS - USNR 6' TWIN BAND CANTER LINE W/2013 PORTER SCANNING - 4-BAY SURGE
DECK - CAE NEWNES/MCGEHEE 6" CURVE SAWING GANG & CAE NEWNES/MCGEHEE
4" BOARD EDGER - PORTER/CAE NEWNES SCANNERS - COE 16' TRIMMER
COE 16', 15-BIN SORTER - COE 16' STICKER STACKER - JEFFREY 55WB HOG
(1) ACROWOOD 5216-6K CHIPPER & (2) CAE 62" 10K CHIPPERS
(6) EDEM BALANCED VIBRATORY CONVEYORS - BMM 10'X12' 2D CHIP SCREEN
(2) PEERLESS 40-UNIT CHIP BINS & (3) 30-UNIT CHIP BINS - CAROTHERS SURGE BIN
(3) WESTERN PNEUMATICS/TWIN CITY DUST COLLECTORS - (2) SULLAIR 350 HP
COMPRESSORS & (1) SULLAIR 150 HP COMPRESSOR - (1) AIR TEK 4000 SCFM & (1)
GREAT LAKES 800 SCFM DRYERS - (2) WAGNER L120 LOG STACKERS- JOHN DEERE 220
LC EXCAVATOR - CAT D8H DOZER - CAT 966F & 966C WHEEL LOADERS - (2) HYSTER
H210HD FORKLIFTS - HYSTER H210XL FORKLIFT HYSTER H190XL FORKLIFT - HYSTER
S50X FORKLIFT CAT 769 ROCK TRUCK - CASE 580E BACKHOE - BROCE RJ300 BROOM
- PETERBILT TRACTOR - KLEIN 26' TANKER - (4) PICKUPS - (2) TRUCKS - (110±) LOG
DECKS, HAULS, TRANSFERS, CONVEYORS & ROLLCASES (ALL W/REX OR SKK DRIVES)
MILL ELECTRICS - FILING ROOM EQUIPMENT - MILL SMALLS & STORES
AND MUCH MORE!



MURPHYAUCTION.COM - 1.800.426.3008
BID LIVE OR BID ONLINE WITH MURPHYLIVE



Viking® Machine Parts For Sale

Call Jerry Lottes Parts Sales
 (PH) **704-283-1920**
 (CELL) **704-221-2205**
 (FAX) **704-283-8716**



**NEW PRECISION
 58" Chipper**



Ben Jones Machinery
 Div. of Dickert Enterprises, Inc.
 Industry's Most Trusted Source

800-241-8983

See more equipment at
www.benjones.com

Your Cut Stock Source

www.SomersLumber.com
 (704) 539-4751



Now offering
 Common Carrier Services
 • SYP Cut Stock
 • Panel Cut Stock/CNC
 • Band Groove

Union Grove, NC

Thinking Auction?

DON'T GAMBLE!

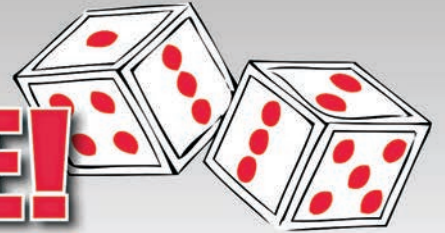

ASSOCIATED AUCTION & Liquidation Co. IS THE RIGHT CHOICE!

For Auctions with Options!

On-Site Auctions

Online Bidding at ALL Sales!

Aggressive Advertising & Promotion

Plans to fit Large Plants, Small Operations or Surplus Assets

On-Line Auctions

MOST WITH GUARANTEES YOU CAN TAKE TO THE BANK!

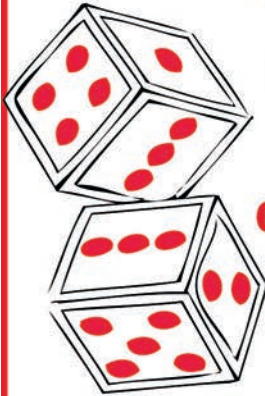

To Schedule a No Obligation
 Consultation Call **800-598-3651**

PO Box 147, Clarksburg, TN 38324
 Fax: 731-986-4529

www.associatedauctioncompany.com
sales@associatedauctioncompany.com



G401 Sawmill Setworks

2 YEAR WARRANTY



Compare prices and features. Our G401 Setworks is the ultimate saw controller, packed with features, rugged, and built to last with non-proprietary components. Call us or visit our website for more information on our other sawmill control solutions: Edgers, Trimmers, Resaws, Scraggs, Tallies, Customized Systems and more!

Thomas Industrial Controls

www.thomasic.com 1-866-899-0495



HOGZILLA

MONSTER TUB & HORIZONTAL GRINDERS, Electric or Diesel Power



TC-1664SE Stationary Electric Powered Hogzilla Shown. Give us a call about converting your diesel powered machine to Electric Power.

CW Mill

Equipment Co., Inc.,
 Sabetha, Kansas U.S.A.
 Toll Free: **800.743.3491**
 P. 785.284.3454 F. 785.284.3601
 Email: hogzilla@cwmill.com

www.HOGZILLA.com

SMALL EUROS WANTED

31.5 x 47.5 - Full & Half Loads

Ruma Pallet
617-455-1184

e-mail: pallets@rumas.com

2001 Timberwolf 36-22/38 HD



w/38 HP Kubota Diesel Engine

581 hrs.

Location: Oregon
 Ad #: 16989

\$22,500

SAWMILL EXCHANGE

800-459-2148

www.sawmillexchange.com



HARDWOOD MARKET REPORT



The Acknowledged Source for Hardwood Information.



Contact us or go online at hmr.com for a sample copy

Tele: 901.767.9126 ~ Fax: 901.767.7534
 Email: hmr@hmr.com • Website: www.hmr.com

SAVE \$\$\$

Our metal connector plates repair wooden pallets to a like-new condition. High quality, superior strength.



Ready to Ship!

PALLET REPAIR SYSTEMS, INC.

866-546-8864

Fax: **217-291-0008**

www.pallet-repair.com/alp

NEW YEARS RESOLUTIONS

- REDUCE RAW MATERIAL WASTE
- INCREASE PRODUCTION
- DECREASE LABOR
- KEEP EXPENSES LOW

.... BUY A **BAKER!**

BAKER Products
Your Log to Lumber Leader

P 573.663.7711 | F 573.663.2787
 info@bakerproducts.net | www.bakerproducts.net
 55480 Hwy 21 N, PO Box 128, Ellington, MO 63638

CALL TO GET YOUR INFO PACKET TODAY!

Model 3665D Blue Streak™ Portable Band Sawmill



Model "C" & "CX" Band Resaws



Features

- Extra-wide "CX" models available
- All three phase voltages available
- Optional non-powered hold downs or **powered** hold downs for 4-sided feedworks

Notcher



Happy New Year
from
BAKER Products

BAKER Products

PO Box 128
 Ellington, Missouri 63638 USA
 E-mail: info@baker-online.com
 Fax: (573) 663-2787
 Phone: (573) 663-7711

www.logtolumber.com



WWW.FRONTLINEEQUIPMENT.NET
FRONTLINE EQUIPMENT, LLC
 Out Front Where Things Happen

FRONTLINE EDGER
 MODEL F642



FRONTLINE EDGERS

Now Available!

The F642 HD Edger is designed and patterned after the long lasting and dependable Reckart Edger. The same Heavy Duty construction and quality-craftsmanship you have come to expect from Reckart Edgers is now built into the FRONTLINE Edgers with most parts being interchangeable. Call today for information on the New FRONTLINE Edgers and other equipment FRONTLINE is now manufacturing.

9267 Front Mountain Road
 Allensville, PA 17002

717-483-6556

Fax 717-483-6051

Email parts@frontlineequip.com



Blowers F42 & F26



Log Turner FT40



Waste Conveyor