



www.amlumber.com
February 2016

American Lumber & Pallet

Sawmills • Pallet Mills • Woodworking • Logging 1-800-992-3432

Loaded with Pages and Pages of New & Used Equipment and More!

In This Issue:

Auctions

Associated Auction & Liquidation Co.:

March 10th • Forks, WA
Page 52-53

March 19th • Tomahawk, WI
Page 54

James G. Murphy Co.:
February 16th • Shelton, WA
Page 58

April 6-7th • Eureka & Korbel, CA
Page 59

April 27th • Snohomish, WA
Page 60

Shows

Expo Richmond 2016:

May 13-14th • Richmond, VA
Page 50

Northeastern Forest Products Equipment Expo:

May 6-7th • Essex Junction, VT
Page 51

Hardwood Manufacturers Assn. Conference & Expo:

March 9-11th • Fort Worth, TX
Page 51

Hot On The Market!

Rough Terrain Forklift
Pallet Stacker
CNC Guide Dresser
... Page 65

**ONE SUPPLIER FOR ALL OF
YOUR EQUIPMENT NEEDS**

2400C Chop Saw

Multiple Head Trim Saw

1000 Series Edger

**PALLET PRODUCTION • SCRAGG MILL SYSTEMS
SAWMILLS • RAILWAY TIE PRODUCTION
MATERIAL HANDLING • STACKERS • BLOWERS
STAKE POINTERS • BARK CONVEYORS**

**COME SEE US AT THE SHOW!
NWPCA ALC: March 2-4, Booth #214**

PENDU

800.233.0471 717.354.4348 www.Pendu.com

91-2

PRESORTED
STANDARD
U.S. Postage Paid
Atlanta, GA
Permit No. 3592

AMERICAN LUMBER & PALLET
P.O. BOX 1136
FAVETTEVILLE, TN 37334



Grizzly Industrial

PURVEYORS OF FINE MACHINERY®, SINCE 1983!

- ALMOST A MILLION SQUARE FEET PACKED TO THE RAFTERS WITH MACHINERY & TOOLS
- 2 OVERSEAS QUALITY CONTROL OFFICES STAFFED WITH QUALIFIED GRIZZLY ENGINEERS
- HUGE PARTS FACILITY WITH OVER 1 MILLION PARTS IN STOCK AT ALL TIMES
- TRAINED SERVICE TECHNICIANS AT BOTH LOCATIONS • MOST ORDERS SHIP THE SAME DAY

12" HORIZONTAL RESAW BANDSAW

SPECIFICATIONS:

- Main motor: 20 HP, 220V/440V*, prewired 220V, 3-phase
- Amps: 48A at 220V, 24A at 440V
- Hydraulic tank motor: 2 HP, 6A/3A
- Hydraulic pressure: 775 PSI
- Variable feed speed: 32–82 FPM
- Maximum cutting capacity: 12" x 12"
- Blade to conveyor table distance: ¼"–5"
- Saw wheel size: 28"
- Saw blade size: 168" x 1"
- Saw blade speed: 7300 FPM
- Conveyor belt size: 215¼" L x 11¼" W
- Conveyor table: 102" L x 12" W
- Floor-to-table height: 35½"
- Overall size: 81" W x 65½" H x 108" D
- Approximate shipping weight: 2778 lbs.

FEATURES:

- Two 4" dust ports
- Return rollers
- Adjustable blade guard
- Manual cutting height adjustment
- Variable feed speed by hydraulic drive
- Manual blade tension adjustment by handwheel
- Movable control panel
- Carbon steel guides
- Steel frame construction
- Steel conveyor table
- Rubber conveyor belt
- 8" Cast iron pressure rollers with polyurethane tires

Includes a Lenox® Carbide-Tipped Thin Kerf Blade



G0503 ~~\$9350⁰⁰~~ **SALE \$7750⁰⁰**



16" DUAL CONVEYOR HORIZONTAL RESAW BANDSAW

SPECIFICATIONS:

- Main motor: 30 HP, 220V/440V*, prewired 220V, 3-phase, 72A/41A
- Elevation motor: 1/2 HP, 2.2A/1.1A
- Maximum capacity: 16" wide x 10" high
- Blade to conveyor table distance: ¼"–10"
- Blade size: 180" x 1"
- Blade speed: 7300 FPM
- Blade wheel size: 28" x 7/8" thick
- Conveyor belt sizes: 215¼" L x 15¼" W and 215¼" L x 7¼" W
- Variable feed speed: 0–61 FPM
- Feed conveyor table: 106" L x 16" W
- Floor-to-table height: 40"
- Overall size: 85" W x 83½" H x 108" D
- Approximate shipping weight: 4325 lbs.

FEATURES:

- Digital height control for accurate blade positioning within 0.01" (enter the thickness you want and press a button)
- Variable-speed, hydraulically-driven feed and return conveyors
- Powered saw elevation
- Hydraulic blade tensioning with gauge
- Two 4" dust ports
- Adjustable ceramic blade guides
- Massive steel frame construction
- Steel conveyor table
- 4" Cast iron pressure rollers with polyurethane tires
- Bi-fold doors
- Simple and quick blade changes

Includes a Lenox® Carbide-Tipped Thin Kerf Blade



G0504 ~~\$17,500⁰⁰~~ **SALE \$16,295⁰⁰**



*To maintain machine warranty, 440V operation requires additional conversion time and a \$250 fee. Please contact technical service for complete information before ordering.



1-800-523-4777 grizzly.com



TECHNICAL SERVICE: 570-546-9663 • FAX: 800-438-5901
2 GREAT SHOWROOMS!
BELLINGHAM, WA • SPRINGFIELD, MO

SCAN QR CODE TO VIEW VIDEO LIBRARY



FOLLOW US:



TO MAKE EVERY DOLLAR COUNT— YOU HAVE TO MAKE EVERY CUT COUNT



Selecut® V with Inline Squeeze

- For prime lumber cut to length or Precision End Trimming needs, our Selecut®-V uses a Fixed Frame Assembly with a moveable cutting platform to meet your production needs in a limited space environment and is available with our Inline Power-Squeeze Package Alignment system.
- For high-volume automated crosscutting of industrial length stock, our Autocut®-V uses a computerized carriage assembly with PLC controls enabling you to process lumber without an operator present.

Transcut® II Station
from \$26,999*

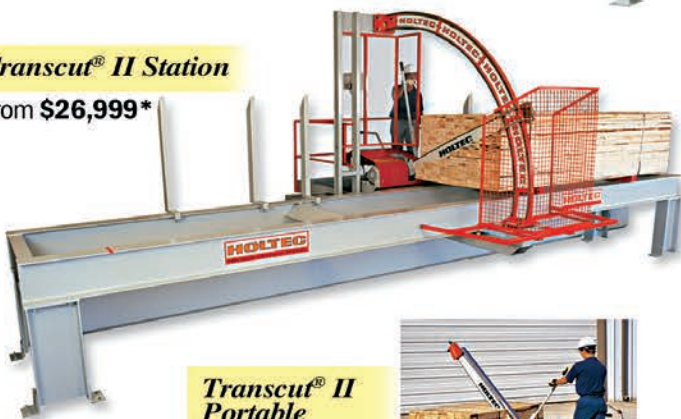

Transcut® II Portable
from \$7,999*



Autocut® V

- For custom manufacturers, our Transcut® II Station will cleanly cut through a unit of hardwood or softwood in less than a minute using generic chain-saw chain and with a precision of +/- 1/16th" or better*.
- For simple crosscutting of EWP or lumber, our versatile Transcut® Portable saws are priced and designed to offer a significantly safer and faster alternative to hand-held chain saws.

We're proud of the fact that HOLTEC pioneered the concept of precise package cutting over 40 years ago. Today our industry's technological and manufacturing advances have enabled us to achieve the fastest cut in the industry and an unmatched precision on every cut. So, if you're considering investing in a package-crosscut saw, consider these facts*:

- At 55 seconds per cut HOLTEC systems cut up to twice as fast as other systems available today;
- With our own team of dedicated Field Technicians and service vehicles, HOLTEC is the only company that provides you a service response time of 24 hours or less on-site and on-time;
- Our state of the art Germany manufacturing facilities are ISO-9001 certified, ensuring that you're getting the highest quality manufacturing standards available today;
- With an unmatched precision of +/- 1mm (.040"), HOLTEC systems exceed precision-end-trim tolerances;
- HOLTEC systems are designed with the highest safety standards in the world, ensuring that your employees are working in the safest environment for package-crosscutting available today;
- HOLTEC has almost 2,000 systems in North America and over 8,000 systems delivered worldwide, ensuring that we'll be here for you in the future as we have been for the last 40 years

WE ENSURE EVERY DOLLAR COUNTS BY ENSURING EVERY CUT COUNTS

HOLTEC®
PRECISION CROSSCUT SYSTEMS

www.holtecusa.com

**Holtec [USA] Corporation, 2802 Sydney Road, Plant City, Florida 33566 • [813] 754-1665 • Fax [813] 752-8042
TOLL FREE 1-800-346-5832 • eMail: info@holtecusa.com**

*All specifications are subject to change without notice. Pricing is FOB Tampa, Florida and subject to change without notice. Photographs may show systems with optional accessories. On-site service may not be available in certain remote locations. Proper maintenance procedures are essential for accuracy and longevity, and accuracy results are based on HOLTEC installed systems using Scratcher® chain technology. Stroke speed may vary based on specie and dimension of lumber. HOLTEC, TRANSCUT, SELECUT, AUTOCUT & MAXIMUS are registered trademarks of HOLTEC GmbH. All other trademarks are the property of their respective owners. Warranty and guarantee terms are subject to limitations and delivery or installation to certain remote locations may incur additional charges. ©2015 HOLTEC (U.S.A.) Corporation

Ask About Our Freight Assistance Program!

We Have the Industry's **BEST** Reputation for Used Sawmill and Planing Mill Equipment!



Armstrong No. 2 Sharpener



Kockums 6x6 Chip Screen



Mill Power Vibrating Conveyor



Soderhamn 7x7 Chip Screen



USNR 32-Knife Planer Line



Ripjack Pallet Plater



Morbark 640 Debarker



6-Arm Tilt Hoist



Smithway XL Ripsaw



Log-To-Sawdust Grinder



Rebuilt 6 ft. Salem Air Strain Bandmill

This is only a small selection from our HUGE inventory.

Visit our website –

www.machinerysales.com

– or call us for help with your next project.



McDonough 54 in. Resaw



Simonds Bandsaw Leveler



Precision 66 in. Chipper



Banding Notcher



Precision 58 in. Chipper



20-Unit Peerless Bin

Over 10 Acres of Machinery In Stock!

Call (Toll Free) **1-866-241-2977**

For a complete equipment listing, go to

www.machinerysales.com

e-mail: machsales@msn.com

info@machinerysales.com



503-285-6691

Fax 503-285-0449

9802 North Vancouver Way
Portland, OR 97217

Visit our YouTube channel at www.youtube.com/user/machinerysales1

Unleash the Awesome Power of the Verticut P4!

Now with inline
(One step Cut in Two)

SQUEEZE

Learn more about
L-M Equipment
on

YouTube

Search:
LM
Corporate
Video

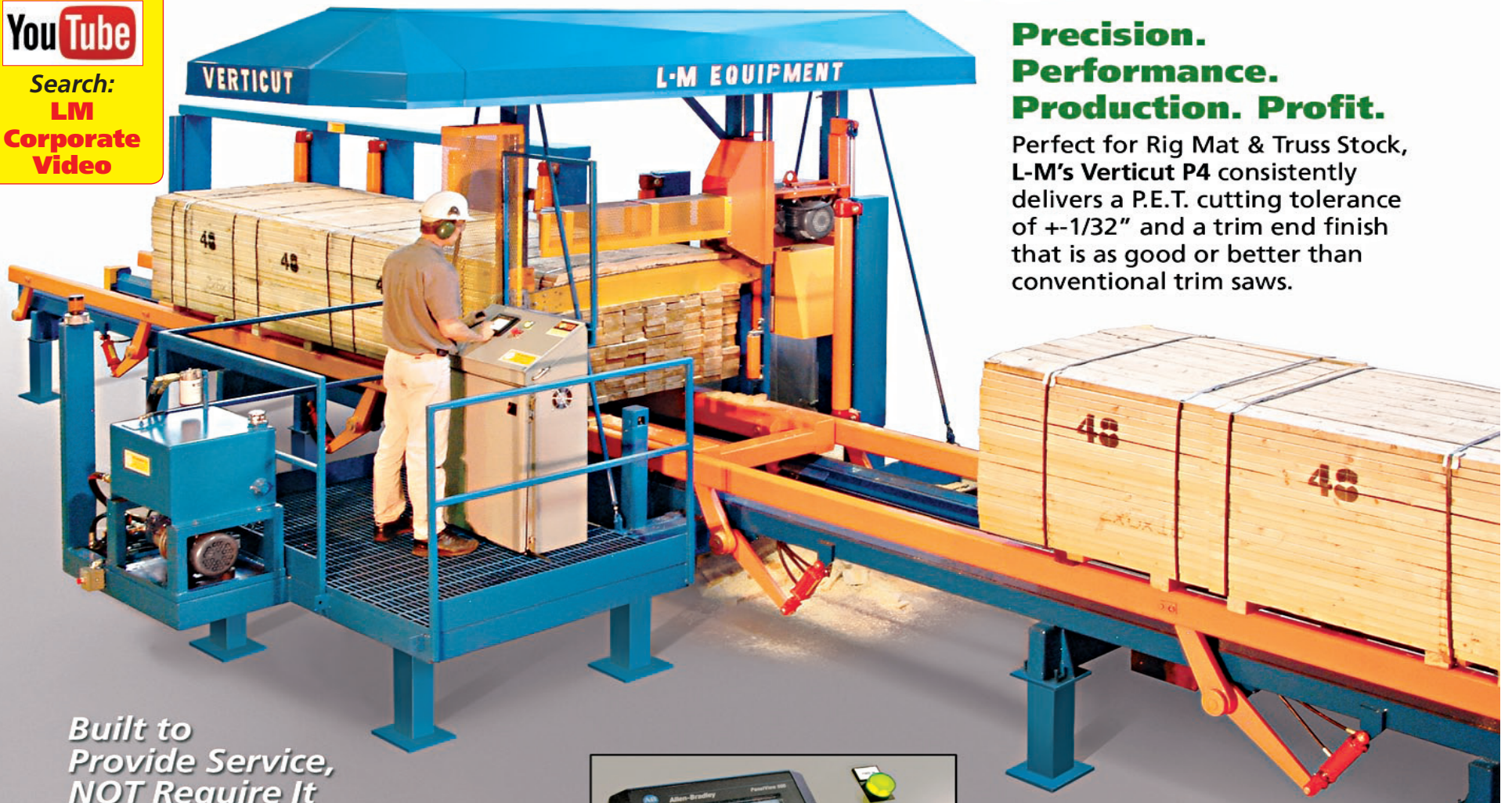

**Precision.
Performance.
Production. Profit.**

Perfect for Rig Mat & Truss Stock, L-M's Verticut P4 consistently delivers a P.E.T. cutting tolerance of $\pm 1/32$ " and a trim end finish that is as good or better than conventional trim saws.

*Built to
Provide Service,
NOT Require It*



The Verticut P4 is one great machine in the L-M family of efficient, cost effective package lumber cutters. With 60 years in the business, L-M Equipment has more package cross cut systems in operation than any other manufacturer in North America. We serve customers around the world.

Contact L-M Equipment for more information!

Features include:

- Programmable touch screen
- Automated PLC controls
- Remote starting
- Operator weather protection
- FACT™—Fast Advance Cutting Technology to substantially reduce cutting cycle time.



**L-M Equipment
Company Ltd.**
604-576-0088 • Fax: 604-576-0089
Toll Free 1-800-455-8807
Email: sales@LMSaws.com
www.LMSaws.com



**Portable
Yard Saw**



I-CUT

WHEN IT COMES TO MOLD CONTROL...

NOBODY STACKS UP BETTER THAN ISK.



The truth is, mold can make your pallets look bad...smell bad...and worst of all, it's bad for business—eating away at your productivity and profits. The good news is, for proven mold control in finished pallets, few other suppliers compare to the service and performance you get from ISK Biocides.

For the food, pharmaceutical and paper industries, we offer a full range of effective mold-control treatments for the many different processes of pallet production. All backed by our unmatched service and 80 years experience in wood preservatives. In fact, our knowledgeable sales representatives help you find not only the best product for your particular mold problem, but the best solution that fits your manufacturing operation.

So whatever your mold problem or production need, trust ISK for a better solution that's truly better for your pallet business. Call your ISK Biocides representative today about our full line of mold control treatments. And see for yourself how well we stack up with real experience, proven performance and lasting value in mold protection!

Stop Mold Cold...Start With ISK!

- 80 Years of Experience in Proven Mold Control
- Full Line of Mold Control Products for Food, Pharmaceutical and Paper Industries
- EPA-Registered Treatments for Mold Control
- PQ-80 is approved for food contact
- Personalized and Responsive Customer Service

NeXgen® | PQ-80® | Tuff-Brite®





1-800-238-2523 • 416 East Brooks Road • Memphis, TN 38109 • www.iskbiocides.com

NeXgen® and Tuff-Brite® are registered trademarks of ISK Americas Incorporated. PQ-80® is a registered trademark of IBC Manufacturing Company.

BANDSAW WHEELS

- New & Used From 20" to 108" Dia. Steel Wheels.
- For All Makes And Models of Bandmills Including Replacements For Cast Wheels.
- Portable Bandmill Wheels and Components.



Premier Bandwheel & Equipment Ltd.
 Phone: (604) 591-2080
 Fax: (604) 591-2835

www.premierbandwheel.com
 E-Mail: sales@premierbandwheel.com

Precut Pallet Stock Hardwood & Aspen

Lumber Resources delivers throughout North America

Call Philippe or Gilles Martel @ 1-866-815-0404 (toll free)
 Or e-mail: pleblanc@rlumber.ca
 418-624-0038
 fax: 418-624-1008
www.rlumber.ca
 "Your Lumber Store!"

Minimize Log Splitting



Save time and money by quickly inserting our heavy 14 ga. S-Irons into the ends of logs and timbers to reduce splitting or checking. Unique ribbed design provides greater holding power. Available in 4", 5" or 6".

QUOTES ON REQUEST

1-800-325-3770 fax: 636-305-1119

 **WESTERN WIRE PRODUCTS CO**
 Since 1914 770 Sun Park Dr. Fenton, MO 63026
www.westernwireprod.com sales@westernwireprod.com



American Lumber & Pallet

Sawmills, Pallet Mills, Woodworking, Logging

Published Monthly By:
ASKINS PUBLISHING GROUP, INC.
 P.O. Box 1136
 Fayetteville, TN 37334

PUBLISHER/EDITOR
 Bill Askins
bill@amlumber.com

ADVERTISING SALES
 Shawn Askins
shawn@amlumber.com
1-800-727-9684

Randy Tallman
randy@amlumber.com
1-800-992-3432

CIRCULATION DEPT.
circulation@amlumber.com

GRAPHIC DESIGN DEPT.
 Jeff Moyers
jeff@amlumber.com

Barbara Locker
bop@amlumber.com

PHONE: (931) 433-1010

TOLL FREE:
800-992-3432
Anywhere in the U.S.A. & Canada

FAX: 931-433-1081

E-MAIL alp@amlumber.com
www.amlumber.com

Subscriptions (Presorted Standard Mail)
 Free to Sawmills, Pallet Operations, Woodworkers, Veneer & Chip Mills and Loggers with portable sawmills in the U.S. Other businesses or individuals in the U.S. \$25.00 per year.

Subscriptions (First Class Mail)
 U.S.A and CANADA - \$50.00 per year.
 Other foreign subscriptions call for prices.



Any advertising copy submitted for publication is deemed the property of the advertiser, and is used on the condition that all liability for copyright laws is the sole responsibility of the advertiser.

©August, 1990



**Newman KF-100
16 Ft. Prefeeder
Please Call 216-389-4358**

FOR SALE
READY FOR OPERATION
Hardwood Sawmill
Located in South Central Kentucky



Call For Price!

Selling land, equipment and rolling stock. Mill sits on 15 acres of land with an adjacent 27 acres available for purchase for expansion. Mill includes debarker, 8' band head rig, linear carriage with scanner, 8" gang/edger, trimmer, grading station, chipper and complete filing room. 3 front end loaders and 4 trucks with numerous chip vans, flat beds and open top trailers. Also includes complete circle mill, installed, with carriage, saw husk, 6" gang/edger and chipper. This business is centrally located providing excellent access to lumber markets and log supplies from KY and TN and surrounding states. Management and key employees are available for operation if needed.

See the mill in operation:

Video URL:

www.youtube.com/watch?v=sZNUmFqzX-0

Phone: (606) 688-2041

De-Dust Boards As You Saw!

U.S. Pat. #'s
6,412,380 6,889,589
6,986,300 7,325,473

We make guides for these brands and others.

We make, re-crown and re-band wheels!!

BREWCO PRESSURE GUIDE

WHEEL SCRAPER BRACKETS

WHEEL SCRAPERS
1 INCH
2 INCH

BAKER

BREWCO

MORGAN

UNIVERSAL

FASTLINE

GO FAST

BREWER

BAKER PAQ & PAQ II

- NEVER buy another set of guides — just replace inserts!
- NO board deduster or hand dedusting needed
- NO modifications to your saw required. Just dust-free boards as you cut!

For details, call Ed
800-685-2899
or 270-281-4500

TRI-STAR METALS INC.
1415 East Parrish Ave. • Owensboro, KY 42303
FAX: 270-281-4511 E-Mail tsmi1@roadrunner.com

MADE IN USA

Try our tool risk free for 30 days!

NEW Tech® PCN-55M

TECH

The better alternative for pallet recyclers

More power, less weight & better durability.

For driving nails 1-3/4" to 2" with diameters .083" to .090", we proudly introduce the new Tech PCN-55M nailer.

After many years of experience working with pallet recyclers, we've designed our new tool with features like a thicker reinforced nose and contact arm for extra durability, and air flow that is optimized to generate more power with less weight - a third to a half a pound lighter than competitive tools.

Our customers also report that the new PCN-55M holds up better in colder winter temperatures.

Although nail pricing is one component when choosing a company, an even greater consideration for us is the nail guns. Being a recycler, wood density varies from softwood to rock hardwood. The Tech 55M handled all materials with ease. It has increased production by approximately 30%. A single individual was able to increase his output from 200 to 300 pallets per day, very impressive. Overall its proven itself as a money maker for the company.

- Steven Streeter: Enpac Pallets & Crates Inc.

METROPOLITAN
STAPLE CORP.
www.metrostaple.com
info@metrostaple.com
800-255-7209

WV MINE TOOLS & SERVICE, INC.

Try Our Popular **SABER INSERTED CARBIDE SAW BIT.**

Only \$2.45 per bit!

FREE SAMPLES!

▶ Dressing Sticks for wheels...
\$6.00 ea.

▶ **\$75.00** for 4 inch Diamond Jockey Wheels

WV MINE TOOLS & SERVICE, INC.
PO Box 402, MT. Morris PA 15349
weaver399@msn.com

Model 7 Saw Grinder

\$525 w/Grit Wheel

Vertical Edgers
Headsaws
Seraggs
Edgers

\$595 with Diamond Wheel

Tension Lever and Guide Pin assure accurate grinding and easy movement.

"The Saw Boss"

Handle rotates 360° to the best operating position.

The Shorthorn Saw Grinder for Headsaws Seraggs Edgers

Powerful 8 amp motor

Roomy Handle

Sale \$540

~~\$580~~

Motor pivots on base to quickly set lead angle.

Jones Saw Tools 812-354-6981 or your local dealer.

Magnum LT. Changes. Everything.

We asked ourselves "How can we make the Hurdle mill better? The answer was simple - build the best carriage on the planet."



Designed with the latest engineering technology for maximum performance and simplicity.



- ★★★★★
- Simplest carriage ever made
- Tougher - holds massive logs
- 29" dog openings
- 20% more dogging force than others
- 40" knee openings
- 1/2" thick tubular frame
- Variable Taper
- Adjustable Chain Drive
- Less maintenance - fewer moving parts
- Available on the Hurdle Heavyweight Mill

CALL US NOW!
901.877.6251

www.facebook.com/HurdleMachineWorks
www.youtube.com/HurdleMachineWorks

PATENT PENDING
HURDLE MACHINE WORKS, INC.



MADE IN USA

WANTED
4 Strand Heavy Duty Log Deck
w/Debarker Style Stop & Loader!
Call Jacob Weaver
814-425-2500 Ext. 224

PACIFIC TRAIL MANUFACTURING INC.
A difference that will keep you cutting!
888-910-SAWS

Making quality bars here since 1991

NEW BARS
WE REPAIR
ALL MOUNTS
SLASHER BARS
DOUBLE END

Hand made from 500bhn alloy steel. Harder than hell but will not break!

All your 3/4" pitch needs.
Direct from us, the manufacturer!

www.ptmi.net
info@ptmi.net

Are You Using The RIGHT Lumber Markers?
AMARK gives you the best Quality, Price & Service!
Shop online at www.amarkers.com
e-mail: sales@amarkers.com
Call toll free 1-866-662-6275

PALLET CUTSTOCK

Northern Dense Hardwood & Aspen Deckboards & Stringers Notching Available
We Are Now Offering ISPM15 Compliant Heat Treating For Our Lumber
Also Available Anti-Mold/Stain Treatment
Sagola Hardwoods, Ltd.
For the highest quality & best prices, contact: Steve Shirkey
Phone: **906-542-7200**
Fax: **906-542-3524**
E-mail: steveshirkey@att.net

Row Electrical Equipment, Inc.

P.O. Box 2812 • Toledo, Ohio 43606

Your Source for Used & Reconditioned:

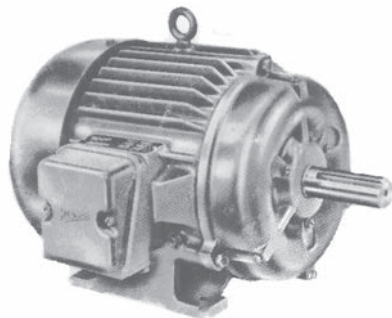

- Squirrel Cage Motors
- Gear Motors
- Wound-Rotor Motors
- Synchronous Motors
- DC Motors
- Phase Converters
- Adjustable-Speed Drives
- Generators, AC and DC
- Engine-Generator Sets
- Transformers, Single Phase
- Transformers, Three-Phase
- Across/Line
- Reduced Voltage Starters
- Safety Switches

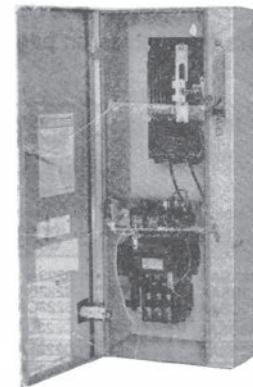

24 Hours a Day Call **800-248-4479** • We Buy Used Electrical Equipment
Visit our website: www.rowselectrical.com • Email: rowelec@glasscity.net

WANTED

West Plains 125 Series 2-6 Head

FOR Sale

- Winston 20' 4 Strand Log Deck w/Stop 'n Loader
- Winston 70' Ladder Back Conveyor
- (2) 3 Strand Winston Roof Top Conveyors, 35' Long x 36" Wide

"No Reasonable Offer Refused"

501-345-2901

BUYING Red Aromatic Cedar Logs

By the foot or by the ton all year.

Call For New Pricing!

MILLER'S CEDAR Call Allen . . . Let Ring
HORSE CAVE, KENTUCKY **270-786-4316**

FOR SALE or TRADE

Salsco 30" Shaving Mill
w/30"x 8'6" Log Box, Blower,
3 sets of knives & 100 HP
Cat Diesel Power Unit.
Can be converted to Elevator!
Great Machine!

"NO Texts Please"

931-636-8453

Brewco Speed Cut
Recently Refurbished
by Brewco



15HP, 20" blade,
w/deck & unscrambler

706-647-8733

Customized Round Saws For Your Mill

Smith Sawmill Service designs and manufactures custom saws to fit your specifications. Our experience, advanced design software and complete CNC machine and saw service are backed by more than 25 years experience serving the wood industry.

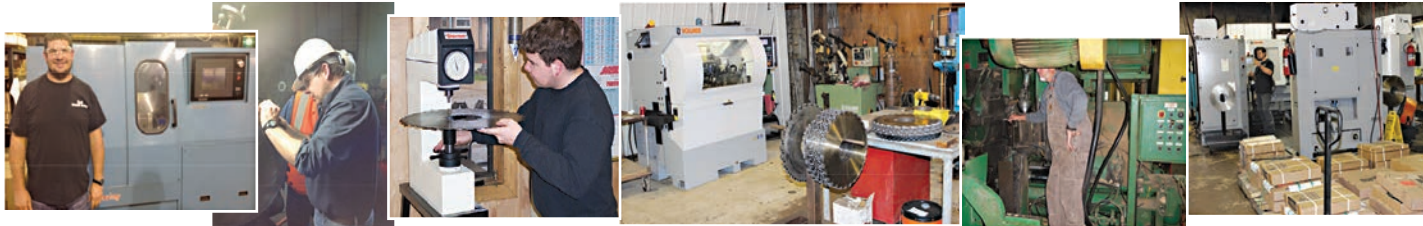

We make sure our customers have the best cutting tools to increase yield and produce the highest quality lumber products in the most efficient manner.

Custom circular saw blades for sawmills & timber processing including:

- Precision Auto Tip- Precision Level
- Curve-sawing & Guided Gangs
- Tensioning that fits your machine
- Edger, Trimmer, and gang saws
- Stellite ® / Carbide / Hard tipping
- Vari-Pitch or Conventional



Our saw teeth give you more grinds with less failure...

- Carbide, Plasma weld & resistant weld tips
- Plates only or saws "Ready to Run"



Our Guided Edger Saws are put through 3 stages of leveling & tensioning to assure the best quality possible.

Over 20,000 feet of floor space and 30+ employees to make sure you get the right saw for the right job!

Check us out at www.smithsawmillservice.com
or call **1-800-598-6344**
e-mail: sales@smithsawmillservice.com

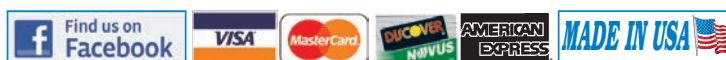

"SAWMILL TOUGH / SAWMILL SMART"

Lumber News Since 1922

HARDWOOD MARKET REPORT

The Acknowledged Source for Hardwood Information.



Contact us or go online at hmr.com for a sample copy

Tele: 901.767.9126 ~ Fax: 901.767.7534
Email: hmr@hmr.com • Website: www.hmr.com

PHASE CONVERTERS

Since 1965

Run your 3-phase machines from 1-phase utility power lines. Run these and more:

- ✓ Dust Collectors
- ✓ Air Compressors
- ✓ Sanders
- ✓ Grinders
- ✓ Shapers
- ✓ Routers
- ✓ Saws



Economical source of three-phase power

PHASE-A-MATIC Call or go online today:
www.phase-a-matic.com 1-800-962-6976

For Many Years The Wood Industry's Most Trusted Source For Previously Owned Equipment!



**FEATURED ITEM
OF THE MONTH**

**DIEHL SL52
Ripsaw**

Give Us A Call Today!

Search Our Complete Inventory at www.benjones.com



DIEHL MR90 Gangrip



USNR 3-Saw Optimized Edger

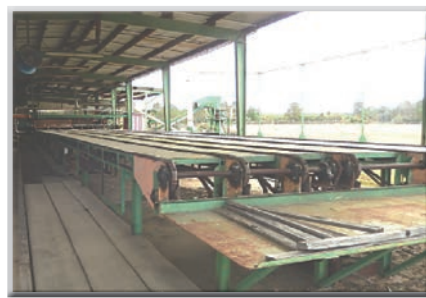

85' Green Chain

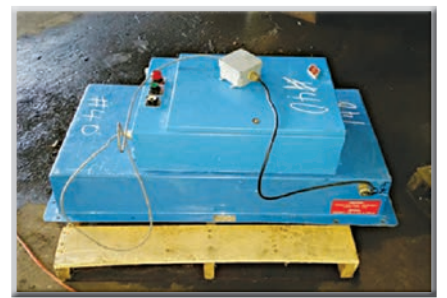

MDI Metal Detectors (New & Used)



8' Lumber Stacker



ARMSTRONG Bandsaw Bench



RECKART Cant Catcher/Slab Drop



HMC 2-Saw Trimmer



PSI 170' Log Crane



JEFFREY 44 AB Wood Hog



KENWELL JACKSON Notcher



KOCKUMS 24" Cambio Debarker



UNITED 144" Magnetic Knife Grinder



TYRONE BERRY 270 Carriage Drive



EDMISTON Edger



PRECISION 58" 6-Knife Chipper



Ben Jones Machinery

Div. of Dickert Enterprises, Inc.

Industry's Most Trusted Source



800-241-8983

Ken Dickert, President

Eric Doss 706-478-1581

Jim Lichucki 706-478-5498

Ken Dickert 706-478-1571

sales@benjones.com



**** Financing Available ****

www.benjones.com

The Best Insurance Money Can Buy For Your Band Saws

The Proctor Roll from Hanchett...

The Roll attaches easily to **ANY** band saw grinder and works automatically as the saw is fed through the roll.

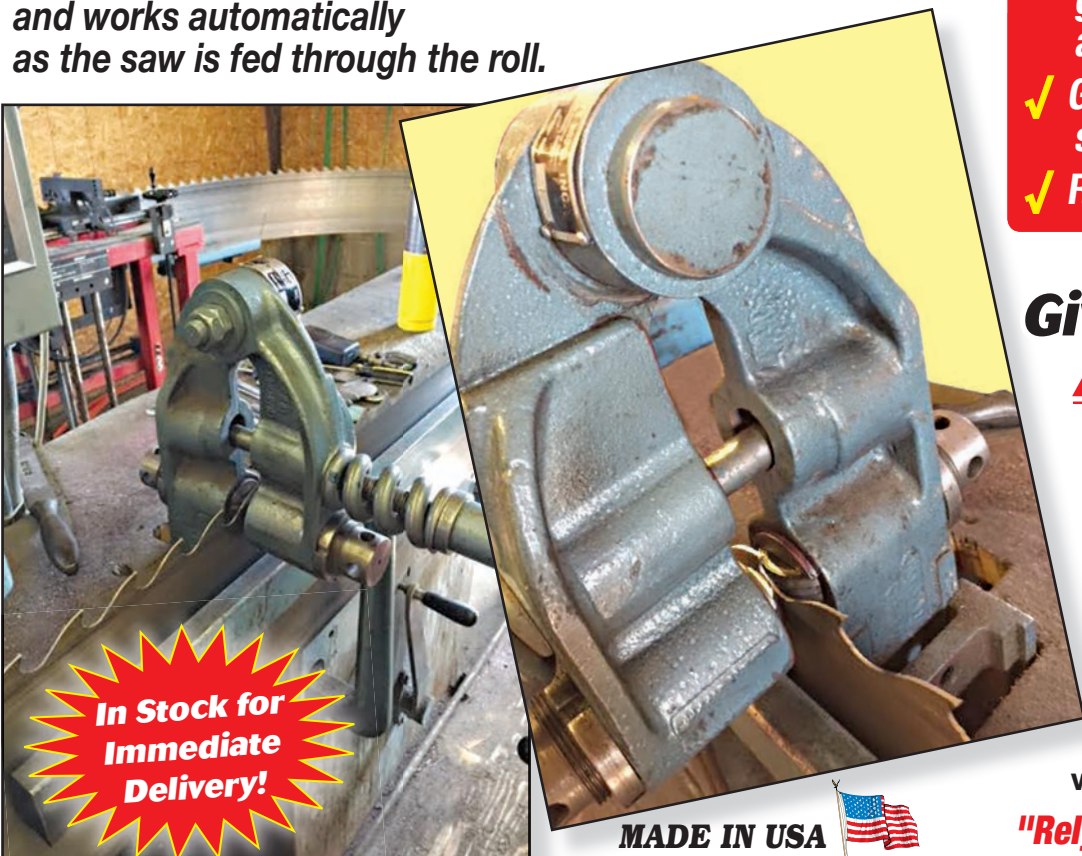

In Stock for Immediate Delivery!

MADE IN USA 

- ✓ Prevents cracks
- ✓ Provides superior tensioning which leads to greater feed, straighter cuts, longer saw life and smoother lumber
- ✓ Gives the gullet a beveled edge so cracks can't start
- ✓ Reduces saw costs

Give Your Band Saws A Fighting Chance!



HANCHETT MANUFACTURING, INC.
800-454-7463
231-796-7678

www.hanchett.com • E-mail: ralphm@hanchett.com

"Rely on Hanchett — Saw Filers Have For Over 100 Years!"



BIOLUBE INC.



Don't Get Stuck with moulder bed build-up. Get Lubie® 200 & GPX.

Lubie® Lube Master the Industry Leader

- For both hard and soft woods
- Eliminate cutter chatter
- Paintable (no wax or silicone)
- Very economical
- High flashpoint

www.biolube1.com
 email: sales@biolube1.com • 260-414-9633

THE TIE THAT BINDS.



Designed especially for pallets, Magnum® nails drive cleaner, hold tighter and run smoother in hand-held pneumatic tools and in high-speed production. Think of Magnum® nails as your steely-eyed partner in profitability... the tie that binds.

800-TOP-NAIL
(800) 867-6245

2700 Central Ave.
 Poplar Bluff, MO 63901

e-mail: nails@magnumfasteners.com
 web: www.magnumfasteners.com

MAGNUM FASTENERS
 by Mid Continent Nail Corp.

You Will **LOVE** the Savings on Plastic!



800-362-9332
 Call Henry, Verna, Susan, Sandra, Sarah, Jennifer, Emily, Gracelyn!
 VISA MasterCard DISCOVER AMERICAN EXPRESS & Check by Fax or Phone
McGREGOR PACKAGING
 Tifton, Georgia
 P.O. Box 7552, Tifton, GA 31793

We Manufacture Short Studs & Pallet Cutstock
 KD HT HF/DF/SPF 1x4, 1x6, 2x4, 2x6
 Any length Cutstock.
 Flatbed delivery.
 Also: Green 1x4, 1x6 MRR
call 1-800-447-3792
 e-mail: tjforest@gmail.com

FOR SALE

27" Nicholson A-2 Debarker
 Purchased refurbished in 2013.
\$69,000
256-773-3233

Everyone has surplus equipment that could be earning CASH.
 Our equipment brokering service is the way to go! Let us handle the hassles and headaches for you. **You can benefit like others... Call us today to get started.**
Check Us Out!
 Call **Jacqueline Kittrell**
931-698-3342
www.kittrellsawmillbrokers.com

Need Hog Parts... NOW? **Toll Free 1-888-244-0161**
Don't Wait - Call The Hogman! www.ellisonsales.com

Cutting Edge Sharpening LLC
"If your cutting edge isn't sharp, then that just won't cut it with us!"
We Offer Superior Quality Resharpenering Of Narrow Bandsaws From Tip To Tip For A Fraction Of The Replacement Cost!

Up to 1.5" Wide:	Up to 2" — 2.5":
8' - 10'....\$6.50	8' - 10'.....\$6.75
11' - 13'....\$7.50	11' - 13'.....\$8.00
14' - 16'....\$8.50	14' - 16'.....\$9.25
17' - 19'...\$10.50	17' - 19'.....\$11.50
20' - 22'...\$12.50	20' - 22'.....\$14.50

Cutting Edge will pay return shipping costs!
 Office:
(715) 610-0421
www.cuttingedgesharpeningwi.com
 430 Pearl Ave. Antigo, WI 54409

YOU CAN DEPEND ON OUR 14 YEARS OF EXPERIENCE & TIMELY TURN-AROUND!

'97 Viking Champion For Sale

304A Nailer, 4-Stringer.
 Comes with HT brander and many extra parts... **\$45,000**
Call Dennis 217-268-5112 for more info.

DTS03 DUAL TOOTH SETTER

First introduced in 1996, retooled in 2003, and still **THE MOST ACCURATE** Dual Tooth Setter on the market. Guaranteed.

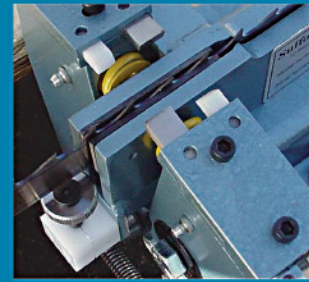

- Equipped with Cobalt up-setting tool bits.
- Sets teeth to within .002 per side.
- Sets from 1" to 2" wide blades.
- Sets from 1/2" to 1-1/4" pitch.
- Hand held Clamp-On Set Gauge included.
- Capable of both increasing and decreasing tooth set.
- Equipped with both Delrin plastic and mild steel down-setting tool bits.
- 3 Blade Stanchion Rollers included.



DTS03
Dual Tooth Setter

Call 800-234-7297
timberwolfbandmillblades.com



IN THE MARKET FOR USED/REFURBISHED HOGS... AND MORE?

CHECK OUT OUR INVENTORY FOR CAN'T MISS BARGAINS.



**Rebuilt Montgomery 42PM-HZF,
10302.01**



**20-Unit Peerless Bin,
10269.01-8**



**10-Foot Diam. Cyclone,
10269.04**

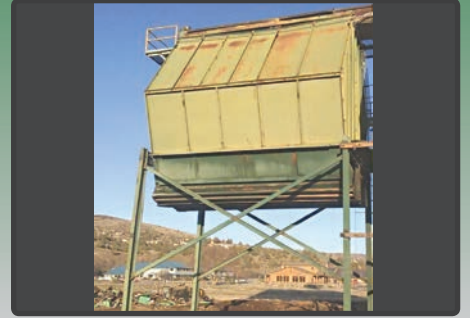

**24-Unit Peerless Bin,
10312-1**



**Cresswood EF-36 Grinder Pkg.,
10326-1**



**Go-Fast Chop Saw,
10325.03-1**



**Pallet Chief II,
10325.01-1**



**Single-Pass Dismantler,
10325.04-1**



**Montgomery 57XLKC,
10225-3**



**Montgomery 45CSKC,
10076-1**



**Helle 3-Block Carriage,
10319**



**Edmiston Portable Sawmill,
10321.01**



**Baldor 150hp 1185rpm TEFC,
10302.01**



**West Salem Magnet Belt Conveyor,
10272-10**



**Precision 58in 6K ChipPack,
10317-1**



**Montgomery Hog 33CSKC,
10323.01-1**

**Already have a Montgomery Hog?
We supply all the parts you'll need!**



ELLISON SALES
Toll-Free: 888-244-0161
E-mail: dan@ellisonsales.com • www.ellisonsales.com

**Portland,
Oregon**

GRINDERCRUSHERSCREEN.COM

NEW & USED RECYCLING EQUIPMENT

- SCREENERS
- GRINDERS
- CHIPPERS
- MULCH COLORIZERS



NEW HAMMERHEAD™ GRINDER TIPS

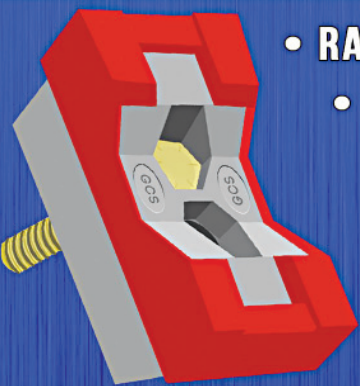

- RADICALLY INNOVATIVE DESIGN
- MORE CARBIDE, MORE STEEL
- LASTS UP TO 92% LONGER
- HIGH QUALITY, LOW PRICE
- PROTECTS BOLT HEADS
- BUILT-UP CORNERS

CALL FOR A SPECIAL TIP TRIAL PRICE

WEST 971-344-0001 EAST 770-433-2670
SALES@GRINDERCRUSHERSCREEN.COM

You'll love how
Pantron Sensors
blast through...



Pantron Sensors

- Blast through steam, sawdust, & fog
- Not affected by vibration or sunlight
- Through-beam range up to 230 feet
- Eliminates need for compressed air

We're Your Source for Authentic Lubie Lube®



We offer biodegradable lubricants free of toxic and hazardous chemicals.

- Lubie spray systems can be adjusted to accommodate up to 12 nozzles.
- In addition to our customizable Lubie 900 system, we offer all replacement parts.
- All lubricants and parts are compatible with Biolube systems.



Adhesive & Equipment, Inc.
1600 Wabash Ave, Suite A
Ft. Wayne, IN 46803

Phone: 260.423.4570
Fax: 260.423.9689

Perfect for Sawmills!



Call toll-free
or visit us
on the web
1-800-211-9468
pantron.com





PORTABLE YARD SAW
This portable chain saw is for cutting logs or packages of lumber. It is available with electric drive or 20 HP gas engine with centrifugal clutch. It features manual or electric start.



HIGH SPEED CHOP SAW
L-M high speed chop saw is available in standard sizes from 48 to 84 inches in diameter. It features a heavy-duty construction frame and saw ladder.



DECK SAW
Deck saw with sawbars of up to 12 feet in length are used to cut the largest of logs, and are also used to split logs length-ways.

VERTICUT 2000-M

Hydraulic vertical guillotine length stops can eliminate the need for a double even ending unit

STANDARD FEATURES

- Safety guarding
- Operator platform
- "Stellite" inlaid sawbar
- Cut accuracy of +/- .040"
- Automatic chain bar oiling
- Package alignment stands
- Standard models for 16' & 20" packages
- Hydraulically powered sawbar activation through the cut

LS SYSTEM 2000 LOG SPLITTER

- Heavy duty Hydraulically powered splitter using onboard HPU.
- Adjustable travel speed using gear reduction for high torque and low power requirements.
- Splits logs up to 60" diameter by 20ft. long
- 54" vertical adjustment capability for slabs-quartering or sizing to mill capacity.

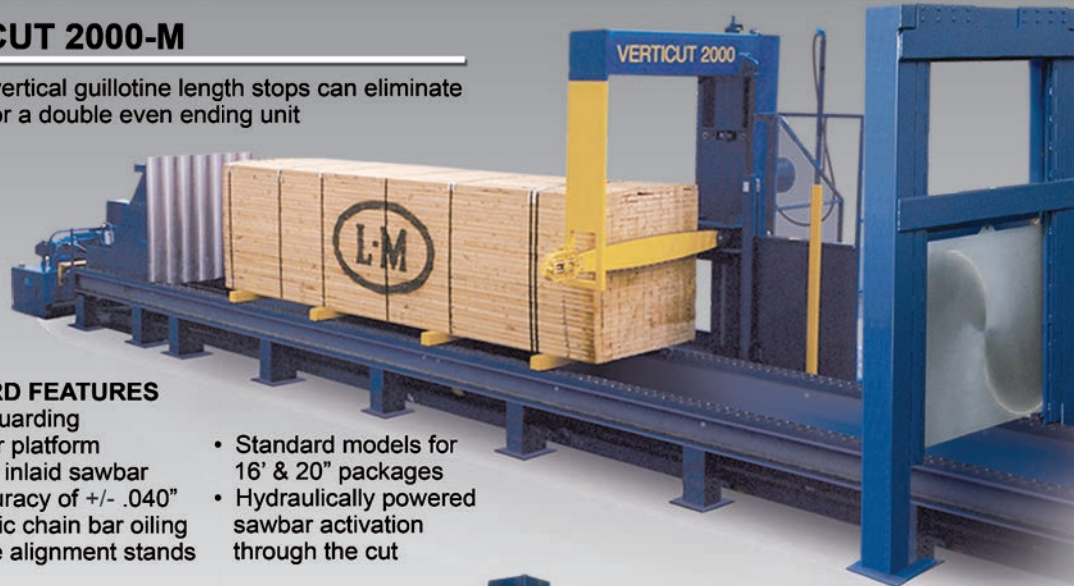

OPTIONS AVAILABLE

- Laser light saw guide
- Modular package end squeeze
- Modular even ending system
- Automatic strapping system
- Modular infeed/outfeed decks
- Electronic length measurement with digital readout
- Powered carriage positioning

The Original



L-M EQUIPMENT Company Inc.

P.O. Box 82111,
Portland, OR 97282
Phone (503) 235-3146
Fax (503) 235-3916
1-800-228-0793
www.lmequipmentusa.com



Leasing available • Call for video

**The One Thing...
Your Circle Sawmill Shouldn't Be Without!**

**The New AccraMax™ Quick-Change Mandrel
Drastically Reduces Downtime!**

- ▶ Features removable wear plates that can be changed out in 15 minutes or less!
- ▶ Save time!
- ▶ Save money!
- ▶ Greater blade cut accuracy!
- ▶ Longer blade life!
- ▶ Faster feeding speeds!
- ▶ Higher consistency!

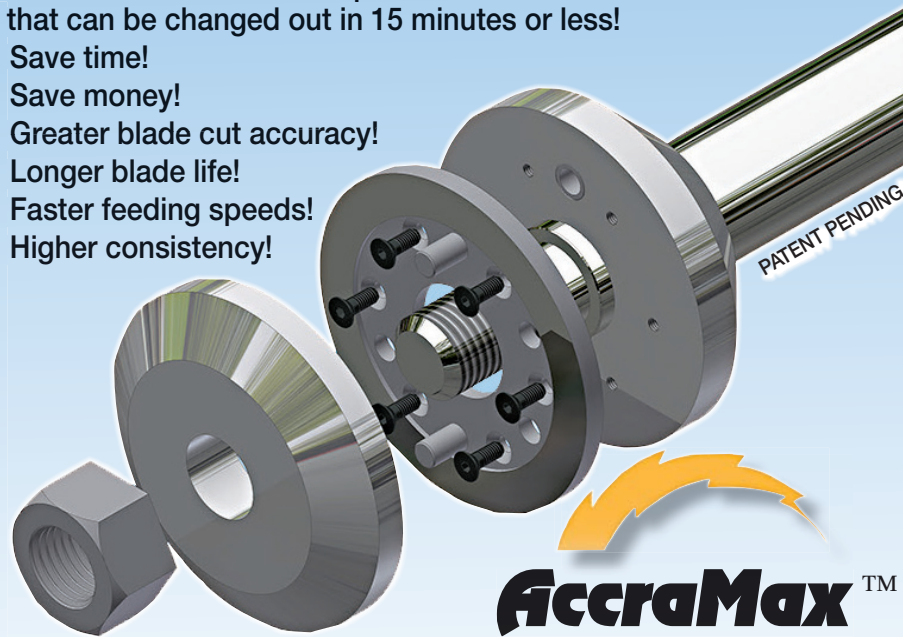

**Plan Ahead —
Cut Your Mill's Downtime.
Time is Money!**

AccraMax™
QUICK-CHANGE MANDREL

For more information, call
260-568-2534 or 260-589-2244
or visit www.accramax.com

Dealership inquiries are welcome

**Why Rely on U.S. Blades
for Your Saws, Blades, Knives,
Filing Room Supplies and More?**

**With 5 technologically advanced service centers,
15 delivery trucks and over 75,000 square feet of
warehouse and factory space, U.S. Blades
consistently delivers the leading edge
to its customers.**

*From the green end to the planer mill,
we are your single source supplier
of high quality knives, saws,
bandsaw blades and related
maintenance supplies
for sawmills.*

Authorized
Dealer For
SIMONDS
INTERNATIONAL
Armstrong

West Monroe, LA
14 employees
3 delivery trucks
15,000 sq. feet

Northport, AL
12 employees
2 delivery trucks
10,000 sq. feet

Florence, SC
27 employees
5 delivery trucks
20,000 sq. feet

Meridian, MS
15 employees
3 delivery trucks
15,000 sq. feet

Hampden, ME
14 employees
2 delivery trucks
15,000 sq. feet

**Find out why
our products are
"Feared by Trees Everywhere!"**

U.S. BLADES

800-862-4544 • www.usblades.net

BELL'S FIREWOOD PROCESSORS

- o CAT Turbo Diesel Engine
- o 54" Circular Saw
- o 23.5" Diameter Capacity
- o Single Joystick Control
- o 42 Ton Splitter Cylinder



Many Models
and Options
to Choose From



Please Call for Details
1-888-995-1965
or visit us online
www.bellsmachining.com
Financing Available



1.866.643.1010 ClearSpan.com/ADALP

WE MANUFACTURE - WE INSTALL WE SAVE YOU MONEY

WAREHOUSING SOLUTIONS FOR ANY INDUSTRY



Fabric Structures
Natural Light & Low Cost Per Sq Ft

Hybrid Buildings
Benefits of Metal & Fabric Buildings

Foundation Solutions
Build Anywhere & Quick Construction

GET **0%** FINANCING FOR **84** MONTHS OR GET A **BIG CASH** DISCOUNT* *RESTRICTIONS APPLY

NEW Like us on Facebook
~ New Specials Often!

Great Buys On Pallet And Sawmill Machinery!

Large Selection
of used equipment
& misc. parts



Morbark PS8



GoFast Deduster

EDGERS

- Baker Slab
- Morgan Slab
- Fastline 8" Slab Edger w/Tailer
- Ribbit Edger

BAND SAWS

- Baker A Gas
- GoFast Single, Gas
- Kent 12"
- Baker A Line Shaft
- Baker 4-Head
- Fastline 4-Head
- Brewco B-800 Double
- Morgan Single

NOTCHERS

- Single Head Notcher

DISMANTLERS

- Disc Style
- Trace Trio

SAWMILLS

- Handset Mills

- HMC Mill
- Edmiston 4 Head Block
- Helle w/Genset
- Forstall Mill
- Log Master LM-6
- Frick O1 Hydraulic
- Jackson 2-Head Block
- Meadows #2 Handset

TRIM/ CHOPSAWS

- Pop Up Saws
- Morgan 2-Saw
- Cornell Chop Saw
- West Plains Chop
- Brewer Chop Line
- Morgan Chop-All Air

NAILERS

- Pallet Chief II
- Pallet Chief 170"

- Gap 960
- Viking® Duomatic

DEDUSTERS

- Baker
- Roblin
- GoFast
- Froedge

CHIPPERS / GRINDERS

- 48" Precision Chip-Pack, 3K
- 58" Morbark Chip-Pac 6K
- 84" Precision Chipper
- Montgomery Hogs
- Challenger Horizontal
- Arasmith 50-48 HSS

DEBARKERS

- Manitowoc Flail
- Portable & Ring

GANG SAWS

- Cornell 500 B
- Brewer 8112 w/Sizer
- Cornell CLB
- Single Arbor w/Sizer

MISC.

- Barn Cleaner
- Chamfer Machine
- Blowers, Many Sizes
- Chip Screens
- Yates A-62 4 Head Planer
- Baker Runaround Sys
- Single Head Planer
- 250 KW Genset
- Timesaver Sander
- Industrial Plywood Cutter

- Cornell 8' Board Stacker

ROLLING STOCK

- Case Dozer 1550
- Barko 80 Loader
- Clark Forklift
- Bandit Chipper w/Loader
- Morbark 1500 B Slasher Loader



Brewer Golden Eagle Resaw



Complete
Tipton Scragg
Merchandizer &
Cut-up Line

Many Decks, Unscramblers and Conveyors

WANTED
Any Sawmill - Pallet Mill Machinery.
Call L&L Today.

LEERAY & LUKE HORTON
218-372-4232
8948 Market St., Sturgeon Lake, MN 55783
E-Mail: llsales@frontiernet.net
WWW.LLSAWMILL.COM

THINKING ABOUT A DEBARKER?

Call The Experts Who've Been Building Them For More Than 60 Years!

Need Electric or Hydraulic? No Problem!

Just send us your specs and we'll build your next Debarker *Your Way!*

The Time to Upgrade is NOW!



HMC is a pioneer in the development of Rosserhead Debarkers. Four models are available to suit most production environments with log diameter ranges 6 - 36", 7 - 42", 8 - 48", 10 - 54" and other sizes, depending on your requirements. These high-quality units feature a slant track design to eliminate log hangup and variable speed controls (either hydraulic or electric) for smooth and responsive log rotation and carriage control.

Get Yours NOW!

Whether a complete "turn-key" sawmill or individual machines to incorporate into your present mill, HMC engineers and builds quality sawmill equipment that maximizes production, ensures safety, needs low maintenance and is rugged and reliable.

— Visit us in Booth #100 at IHLA in Indianapolis Feb. 2-4th —



284 Maple Street
Contoocook, NH 03229

CALL 603-746-4691

www.hmccorp.com

Fax: 603-746-4819 • info@hmccorp.com

Pallet Lumber For Sale
 4/4 Green Hardwood
 Trailer Loads Regularly Available
 Red Oak & Other Species
 Fixed widths of 4" and 6" or RW
 Lengths of 4-8 or 9-12 feet
 Also 5/4 Hickory all 4" 4-8' or 9-12'
 Contact Jon St. Jean
 (860) 974-0127 x14
 stj@hullforest.com



FRICKCO, INC.
 We manufacture & sell parts for Frick sawmills.
 We also sell new Frickco sawmills.
 Call for your nearest dealer.
740-887-3799
 South Bloomingville, Ohio

Engines, Power Units, Gen-Sets
 Detroit Diesel, S53, 71, 92, 60
 Remanufactured & USED
New & USED Parts
 Twin Disk & Rockford Clutches & Parts
 Power Unit Radiators & Gauge Panels
 Specializing in



Leid Diesel Service
 Now 3 Locations to serve you:
 267 Green Hill Rd. - Newville, PA 17241
717-776-7725
 N12574 Cty. Hwy. M - Thorp, WI 54771
715-669-3799
 2952 W. Carson City Rd. - Sheridan, MI 48884
616-754-5871

Kittrell Sawmill Equipment Listings

Call Jacqueline Kittrell To Locate or Sell Equipment
931-698-3342
931-797-6284
 PO BOX 505, COLUMBIA, TN 38402

www.kittrellsawmillbrokers.com



	
Cleereman 75 HP Carriage Drive (PA)	36" Cleereman (4) HB Straight Line Carriage (PA)
	
Precision 636 Slant Track Debarker (TN)	Onan 350 KW Genset (IL)
	
ALH 16' Trimmer (PA)	80' Mellott (4) Strand Green Chain (PA)
	
Cleereman 36" Modular Mill (IL)	Precision 48" 8KN DFTD Chip Pack (TX)

OUT OTHER LISTINGS ONLINE. NEED TO SELL SOME SURPLUS MACHINERY? CALL US NOW TO GET STARTED.

Email: info@kittrellappraisals.com



25 YEARS OF QUALITY & LEADERSHIP

www.brewcoinc.com
 607 Front St.
 Central City, KY 42330
800.237.6880



BREWCO
 INCORPORATED
 RUGGED - RELIABLE - DEPENDABLE

Wood-Mizer CONFIGURATOR **Build & Price your Sawmill at mywoodmizer.com**



Not Just Carriages!

- Carriage Drives Hydrostatic & Electric
- Airbag & Hydraulic Cable Tensioners
- Custom Material Handling Systems
- Bar Type Log Turners 2500 - 3500 lbs
- Sawyers Cabs & Control Cabs
- Contact Us Today For Information

www.cleereman.com | 715-674-2700 | 5500 Pine St., Newald, WI

Your Most Reliable Source for New, Used & Customized Machinery. Call Mona Tracy Today!



The **RUN-A-GADE** Bandsaw Pallet Disassembly System



TRIO
3-Head

BANDSAW DISASSEMBLERS!

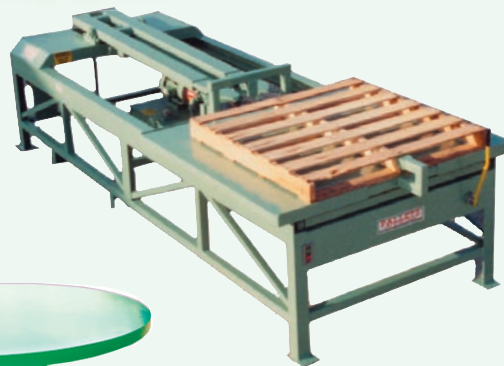

SOLO
Single Head

DISC TYPE DISASSEMBLERS!



MARK I
Bandsaw Disassembler
Make it a complete system with a round table



Manual Chop Saw

LUMBER SAVERS!



TRIM TRAC
End Trim Saw



**High Speed Pop-Up
Cut-Off Saw**



SN20 Automatic Notcher

NOTCHERS!



BLOWERS!



Call Mona Tracy

**Toll Free 1-855-298-8890
or 812-298-8090**



- Corner Rounder
- Chamfer
- Unstubber
- Pallet Sizer
- Round Tables
- Specialty Machinery

www: universalmachinerysales.net

E-Mail: sales.universalmachinerysales@gmail.com

Leasing & Financing Available

The Most Innovative Equipment is a Phone Call Away..



**NEW
4-Head
Design!**

Low Profile BAND RESAWS

Single & Multi-Head Models
Available with or without return
Hands-free return eliminates one operator
Save labor - Save money!



NEW Multi-Head TRIM SAW

2, 3, 4 or 5 head models
Adjustable heads with variable speed, chain feed
drive motor with starter
20" x 40-tooth carbide blades
Quick change adjustable to length

NEW! ANGLE CHOP SAW

Cuts 0° to 45° on a 2x8
and 0° to 40° on a 2x10
Fast Cycle
Easy to set up and operate
Guarded blade for safety



Robo Chop UPCUT SAW

Automatic push feeder,
30,000 B. F./shift. Stacks
boards 5 high & up to 16
wide. Up to 16 ft lengths



Military BAND NOTCHER

Fully Adjustable notch-length of board
Option: Double groove notch and 14" blade
to cut board into two strips



Hopper-Feed BLOCK SAW

Cuts 2x4 & 4x4 blocks from 24" drops
30 hp, 3-phase motor/starter



Self Dumping STEEL HOPPERS



REPAIR BARS!

Call for
Pricing!



STAKE MACHINERY

SCISSOR LIFT



2,000 lbs. to 8,000 lbs. per your specifications



WWW.FRONTLINEEQUIPMENT.NET
FRONTLINE EQUIPMENT, LLC
 Out Front Where Things Happen

FRONTLINE EDGER
 MODEL F642

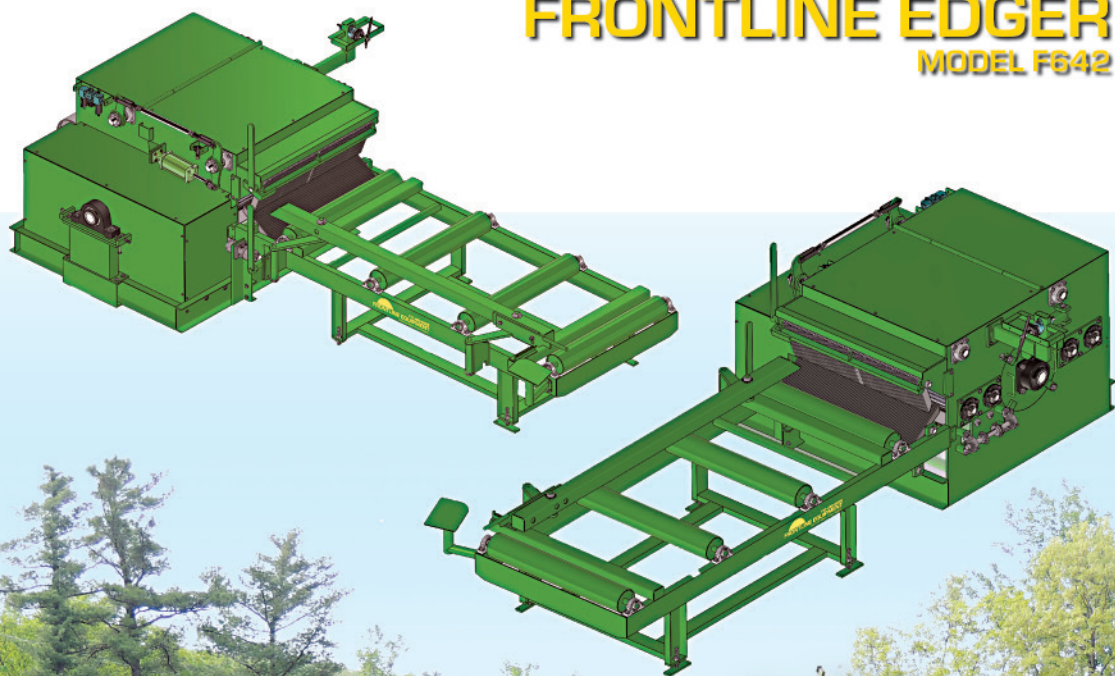

FRONTLINE EDGERS

Now Available!

The F642 HD Edger is designed and patterned after the long lasting and dependable Reckart Edger. The same Heavy Duty construction and quality-craftsmanship you have come to expect from Reckart Edgers is now built into the FRONTLINE Edgers with most parts being interchangeable. Call today for information on the New FRONTLINE Edgers and other equipment FRONTLINE is now manufacturing.

9267 Front Mountain Road
 Allensville, PA 17002

717-483-6556

Fax 717-483-6051

Email parts@frontlineequip.com



Blowers F42 & F26



Log Turner FT40



Waste Conveyor

PARTS & SERVICE

Forest-All,
C.M.C., C.S.P.,
Hilltop Equipment
DICK NOLIN SAWMILL SERVICE
603-724-3942

*35 Years
Experience!*

NOBLE MACHINERY CO.

- New Pallet Hawg Band Dismantler, In Stock
- New Waechter Power Feed Trim Saw
- Baker A Sgl. Resaw w/Go 'Round Return
- Bronco 200 Nailing Machine
- Cemco 54", 84", 120" 6 Spdl. Vert. Borers
- FMC 499 Stacker, 60" Cap.
- Hazlethorn R-180 24" Up-Cut Saw
- Hazlethorn T-145 10" Wide Cant Sizer
- Ind. Resources Pass One Disc Dismantler
- Mid-Oregon Trim Scrap Grinder
- Morgan Double End Trim Saw
- Piche 4-Saw Trimmer w/Conveyor
- Pallet Chief II Nailer
- 2013 Pallet Chief II Nailer, 4 Stringer
- PRS Chain Feed Trim Saw
- Smart Portable Band Saw Dismantler
- 2010 Smart Products Double Head Notcher
- Smetco Tru-Cut Notcher
- Visionary Stake Pointer
- Waechter 2-Head Horiz. Resaw
- West Salem 2-Stage Vertical Grinder
- Rebuilt Whirlwind Up-Cut Saws
- Parts for FMC, Hazeldine & Morgan

1-800-348-0703
www.noblemachine.com
E-Mail: noblemach@aol.com



WE BUY, SELL AND TRADE IN USED

PALLET MACHINERY!

THE MOST REPUTABLE USED EQUIPMENT DEALER IN THE INDUSTRY. WE OWN WHAT WE SELL.



\$9,500

2010 PRS Model F Stacker
2 HP hydraulic system,
480 V, 3 Phase.



\$8,900

T-Tek Pallet Stacker
Handles up to 52" pallets.
Refurbished by PRS in 2015.



\$9,500

Smetco Basic Pallet Tipper
Reduces injury and fatigue. Complete
with motor, starter & hyd. power unit.



\$2,100

Slider Bed Belt Conveyor 20" x 21'
Mounted on legs with casters.
1/2 HP motor
with variable speed control.



\$7,140

Chain Driven Live Roller Conveyor
Effective Width.
Manufactured by Omni Metalcraft.
In good condition. Made in 2014.



\$1,400

Roach Power Belt Conveyor
4' W x 7' L. 1.5 HP motor.
No legs/supports.
Includes motor starter and controls.

SEE OUR WEBSITE FOR MORE USED INVENTORY LIKE:

*Bandsaw Pallet Dismantlers • Notchers • Pallet Stackers • Pallet Platers • Repair Lines • Rotary Dismantlers
Custom Conveyor Systems • Trim Saws • Stack Tipplers • Pallet Sorters • Dispensers • Stringer Splicers*

Our inventory is constantly changing. Visit our website for up to date listings!



30-Day Warranty on Pre-Owned Machines and 90-Day Guarantee on Refurbished Machines!

(844) 892-2322 | PRSGroupInc.com



**PIPER'S
SAW SHOP**

BEST BLADES!

BEST DEALS!

ALL IN ONE PLACE!



**Ask about the
Piper Chopper
for your Scrap Blades!!!**

800-845-6075

FOR SALE OR TRADE

'95 Rayco Nailing Machine, Will Trade For Third Man Nailer!

WANTED TO BUY

- #2 Pallet Lumber
- Line Bar Shims
- Hard Maple 4 x 6's, Special Pricing
- Cross Tie Siding
- 4 x 6 Cants

Elora Pallet Shop
Elora, TN

931-469-5558



50 YEARS OF METAL DETECTION EXPERIENCE

SAVE ON COSTLY REPAIRS AND DOWNTIME!

You can't afford to have less than the best metal detector protection for your valuable equipment.

TWA-2000-HD



Fiberglass Sections



MP-2000 Series



XR-3000 Series



Phone: 541 345 7454
 Fax: 541 345 7971
www.mdiblue.com

Metal Detectors, Inc.

Proudly made in the USA!

COMPLETE MILL FOR SALE

- 3HD 01 Frick Automatic Carriage w/Mellott #5 Turner, 17' (3) Chain Deck, Mellott Off Bearing Belt, 40' Rollcase, 60' Green Chain, Miner 4" Edger, Detroit 6V71 PU & Grizzly Wide Cut Resaw
- (2) 213 Tyrone Berry Feeds
- HMC 34' Ladderback Conveyor w/New Motor & Gearbox
- (2) Husk Frames

Everything for \$40,000!

615-848-5020 Night
615-477-4683 Day

DOUBLE the Life of your Bandsaw Blades in only 15 Minutes!!!



True Wheel, a patent-pending revolutionary new hand tool machine, will change the way you crown and smooth your bandsaw wheels. The True Wheel will cut your blade usage from 3 to 4 blades per day down to only one! Potentially save \$10,000 to \$20,000 in blade usage per year!

Manufactured & sold by True Wheel LLC Sales & Marketing.

For more information, contact:
931-469-5557 or 931-469-5558
www.truewheelllc.com

Cut Downtime and Keep Your Current Equipment Running!

Count on Brown For Low Prices, Quality Parts and Superior Service.

Sprockets
(Cast, Steel & UHMW Plastic)



Chains
(All Kinds)



Pillow Block/Flange Bearing Units



New/Rebuilt Speed Reducers



Power Drive Units



UHMW Wear Plates In Stock!



Brown Machinery and Supply, Inc.

800-748-9801
 Fax: 870-246-8044
www.brownmachinery-supply.com
 P.O. BOX 9, ARKADDELPHIA, AR 71923
 info@brownmacsupply.com

KEEPING YOUR OPERATION RUNNING SMOOTH FOR OVER 50 YEARS

Third Man Nailer



Jig & Stacker

Call for FREE DVD

Build Pallets Faster and For Less Money!

RT Pallet Equipment

306-737-3310

email: roberttrembley@hotmail.com
www.rtpalletequip.com

View the video on our website.

BOX 29 Imperial SK
S0G 2J0 Canada



Rotochopper EC 366

Call today for more information

PALLET MACHINERY GROUP

540-644-9220

or visit www.palletmachinery.com
 E-mail: info@palletmachinery.com

Your Cut Stock Source
 www.SomersLumber.com
 (704) 539-4751

Now offering
Common Carrier Services

- SYP Cut Stock
- Panel Cut Stock/CNC
- Band Groove



Union Grove, NC

kiln-direct.com

The leading provider of kilns for lumber, pallets and firewood



Pallet kiln
280-1000 pallets



Firewood kiln
6 cord MiniQuick



Lumber kiln
9000-21000 bf

- Portable turn key units with fast treating time
- Heat treats and dries in the same chamber
- Computerized record keeping
- High efficiency direct gas heating
- Aluminum or stainless steel chamber
- End-load models
300-1000 pallet capacity
- Side-load models
280-700 pallet capacity
- Piggy-back system for insulated van body or container
- Wood waste or gas heat
- Easily meets 160F/75mins
- Heat treat in 8-16 hours
- Kiln dries green firewood in 1-2 days
- 6 cord (MiniQuick) up to 24 cord
- Baskets for optimized airflow are available
- MiniQuick firewood kiln has been specifically designed to dry and HT firewood quickly and efficiently
- 100% aluminum construction
- Gas, hot water or steam heated
- Power venting with Heat Recovery
- Bi-fold door with electrical operation is optional upgrade
- Computerized control with wireless communication to office
- Loading capacity from 9000 bf to 21000 bf

Call us today and find out how our pallet, firewood and lumber kilns can increase your profit...

phone 910 259-1624 P.O. Box 159
 fax 910 259-1625 200 A Progress Drive
 www.kiln-direct.com Burgaw, NC 28425

SIMONDS
KILGORE
SAW
COMPANY

**Thin Kerf
 Band Saw
 Blades**

✓ **Check Out Our . . .**
 Quality
 Service
 Dependability
 Price

See why we are your best source for bandsaw blades!

Satisfaction Always Guaranteed

 Toll Free 

1-888-857-5153
 E-Mail: kilgoresaw@prodigy.net

STAKE POINTERS FOR SALE
 Keystone Machinery Corp.
 Ephrata, Pennsylvania
717-859-4977



NEW PRECISION 58" Chipper

Ben Jones Machinery
 Div. of Dickert Enterprises, Inc.
 Industry's Most Trusted Source
800-241-8983
 See more equipment at www.benjones.com

Pallet Dip Tank
 Key Design Features:

- Dip tank is fabricated in 1/8" thick stainless steel, type 304, with external painted enamel mild steel structure.
- Standard pallet carriage for pallet stack up to 114" tall and maximum 2500 lbs weight. Dead packed cut stock can also be dipped.
- Tilting carriage is fabricated in stainless steel and mild steel.
- Tilting carriage has clamp system to insure pallets or lumber is submerged.
- Hydraulic system is used for all mechanical operations.
- Estimated dip cycle for pallets is 4 minutes and is user defined.
- PLC control system with remote control for initiating the dip cycle. Dip time and other parameters are adjustable in the control cabinet display.

 **Eagle Dip Tanks**
 Complete Dip Tank Systems



www.eaglediptanks.com
910 259-9794

Buy and Sell Used Equipment On-The-Go!

Just go to the **NEW amlumber.com** from your tablet or smartphone and find what you need — **FAST!**

The **NEW amlumber.com** on-the-go!



SMART PRODUCTS

Is Your Answer! For Pallet Lumber Recovery and Repair Solutions.

“The Difference is Engineering”

Leasing & Financing Alternatives Available

Dismantlers

One-Man Dismantler



- 52" or 64" capacity
- 10 HP, 3-phase, electric motor standard (2200 FPM blade speed) (single phase available)
- Optional 15 HP, 3-phase (4400 FPM blade speed) electric motor available
- 18 HP gas-powered electric start on Portable Dismantler
- Gear reduction drive
- Self-contained hydraulic blade tensioning
- Low maintenance durable blade guide bearings
- Push button operated table height adjustment

Two-Man Dismantler



Pallet Dismantler System

- 64" capacity **Front Discharge** Dismantler
- Linear accumulating conveyor feeds boards easily to operator of Inclined Power Trim Saw
- Add additional dismantlers for higher production

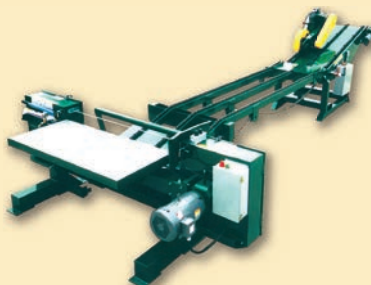

Portable Dismantler



Notchers

Double Head Notcher



- Two, 20 HP, three (3) phase, electric motors with V-belt driven indexable notching cutterheads
- One-person operation/1,000 double notched stringers per hour
- Notches new or recycled lumber
- 48" to 96" stringer capacity standard
- 9" x 1-1/2" notches, with 18" between notches
- Quick set-up
- Continuous power feed system
- Self exhaust design (useful when notching recycled material)

Single Head Notcher

- 20 HP, three (3) phase, electric motors with V-belt driven indexable notching cutterhead
- One-man operation/500 double notched stringers per hour
- Notches new or recycled lumber
- 72" stringer capacity standard
- Quick set-up
- Continuous power feed system
- Self exhaust design (useful when notching recycled material)



Pallet Prep



- Commonly referred to as the "SmartSaw"
- Smart Saw is **multifunctional**: designed for repair (1 person) or recycling (2 person) operations of BLOCK or GMA/STRINGER pallets
- Standard 10 HP, 3-phase, electric motor with gear reduction drive
- 20' standard **M42 bi-metal** band saw blade
- Air actuated, 3-position, roller table and table extension easily positions pallet for board removal
- Machine provided with **advanced safety measures** in place, including interlock switches for perimeter guarding and cabinet doors
- Improved **canopy guarding**, with front and rear portions that move up and down with the roller table

- Specifically designed to QUICKLY (as a **1-person** operation) cut out damaged boards, including **top and bottom** deck boards, as well as **connector** and **stringer** boards
- Also designed, as a **2-person** operation, to process the disassembly / tear-down of block or stringer pallets for **INCREASED LUMBER RECOVERY**. For block style machine, includes a specially designed **Block Recovery Tool** (or BRT) that **salvages blocks** now being scrapped with other machines and processes

Double End Power Feed Trim Saw



Trim Saws

- Power Feed Trim Saws trim boards 2" thick from 18" - 60" in length on the single end, and 18" - 66" in length on the double end
- Inclined board feed and overhead saw design help eliminate board kickback
- Manual Trim Saw handles boards up to 6" thick and 6" wide
- 18" diameter nail resistant saw blades and 10 HP motors
- Heavy duty steel tube construction
- Multiple adjustable board stops on Single End and on Manual Feed Trim Saws
- Easy blade change
- Easily moved with built-in fork lift pockets
- Right saw head on double end easily adjusts to cut desired board length

Single End Power Feed Trim Saw



Manual Feed Trim Saw



SMART PRODUCTS

3401 North Commerce Drive • Muncie, IN 47303
 Ph: 765.284.9545 • Fax: 765.284.7270
 website: www.smartproductsinc.com
 email: smartpro@smartproductsinc.com

800.401.0099

Every machine we build is backed by the pallet industry's most trusted and respected reputation. You can count on us being here long after the others are gone.

We Specialize in Dense Hardwood or Poplar:

- Pallet Deckboards (1x4 & 1x6)
- Stringers (Notched & No-Notch)
- Band-Groove Components
- Custom jobs no problem

For more information

Contact: Keith Barbo
E-mail: kbarbo@wvsr.com

304-472-8131 ext. 111

or 304-439-0392 Cell

Fax: 304-472-0212

WV Forest Products
Website: www.wvsr.com

PO Box 9, 16 Lumber St. • Buckhannon, WV 26201

NEW Wood Saw Pitch Cleaner



Order your FREE sample today!

This new and completely hazard-free wood pitch cleaner is revolutionary in its cleaning action. By immersing the saw blade in a tank, all the pitch and resin is removed, without the need for any heavy scrubbing action. The resinous pitch simply melts away!

Call (413) 525-0660 or visit www.us-fluids.com for more information.



Ask about our **NEW Wood Saw Lubricant** for **Faster, Easier, More Productive Sawing!**

CLEEREMAN SAWMILL MACHINERY

Why has CLEEREMAN Sold 1060 Carriages?

The Answer is Simple... QUALITY & SERVICE!



12 MODELS
A CARRIAGE TO FIT YOUR OPERATION!
COMPLETE GRADE & TIE MILL PACKAGES



Patent Pending

LUMBER PRO



CLEEREMAN
Not just Carriages!

- CARRIAGE DRIVES
Hydrostatic & Electric
- BAR TYPE LOG TURNERS
2500 – 3500 lbs.
- AIRBAG & HYDRAULIC CABLE TENSIONERS
- SAWYERS CABS & CONTROL CABS
- CUSTOM MATERIAL HANDLING SYSTEMS



Heavy Duty Double Cut Band Mill That is Sweeping the Industry.

- 54" or the New 62"
- Reduces Manpower
- Adds Flexibility from 4/4 – 12/4 Lumber, Beams, Cants, Cross Ties or EVEN as a Resaw!
- Lower Initial Installation Cost
- Unmatched Accuracy

All Machines are Cleereman Quality Throughout.
You Get the Best Machines Backed by the Top Service in the Industry – Call Cleereman Today!

INFO@CLEEREMAN.COM
WWW.CLEEREMAN.COM

PHONE: 715-674-2700
FAX: 715-674-7002
5500 PINE ST., NEWALD, WI. 54511



Mixed Hardwood Pallet Cutstock

- 1/2" - 1" Thickness
- 30" to 60" Length
- 3 1/2" - 5 3/4" Width

Stringer Orders Wanted

(Stringers Available in Hardwood and Green Pine)

#2 Pallet Lumber Available at Greatly Reduced Pricing!
(Heavy on 40" & 44" Lengths)

Call Todd or Lisa: 931-296-1455
trichardson@waverlywood.com

Waverly Wood • Waverly, TN

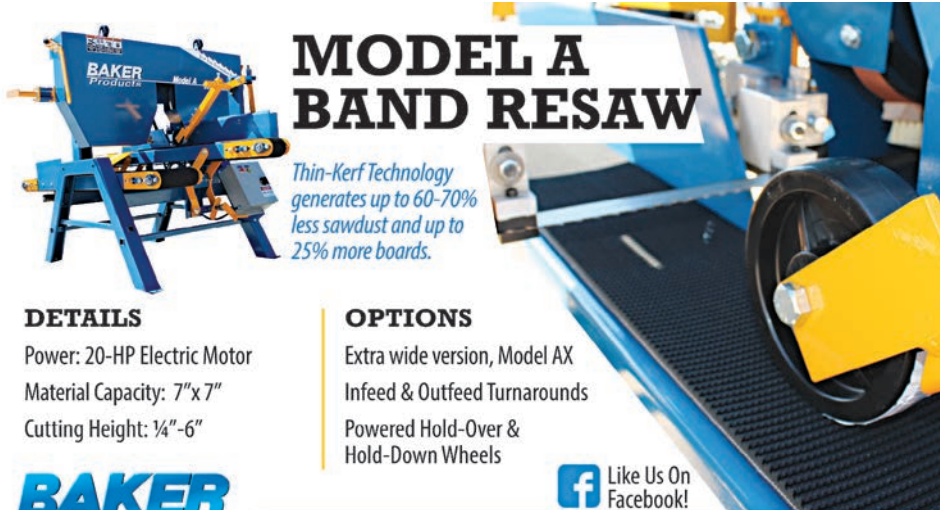

MODEL A BAND RESAW

Thin-Kerf Technology generates up to 60-70% less sawdust and up to 25% more boards.

DETAILS

Power: 20-HP Electric Motor
Material Capacity: 7"x7"
Cutting Height: 1/4"-6"

OPTIONS

Extra wide version, Model AX
Infeed & Outfeed Turnarounds
Powered Hold-Over & Hold-Down Wheels



573.663.7711 800.548.6914 BakerProducts.net info@BakerProducts.net



THINKING OF MAKING YOUR OWN CUT STOCK?



For Your Next Scragg
Call the Big Jake Himself,
Dennis Franks at
417.257.8190.

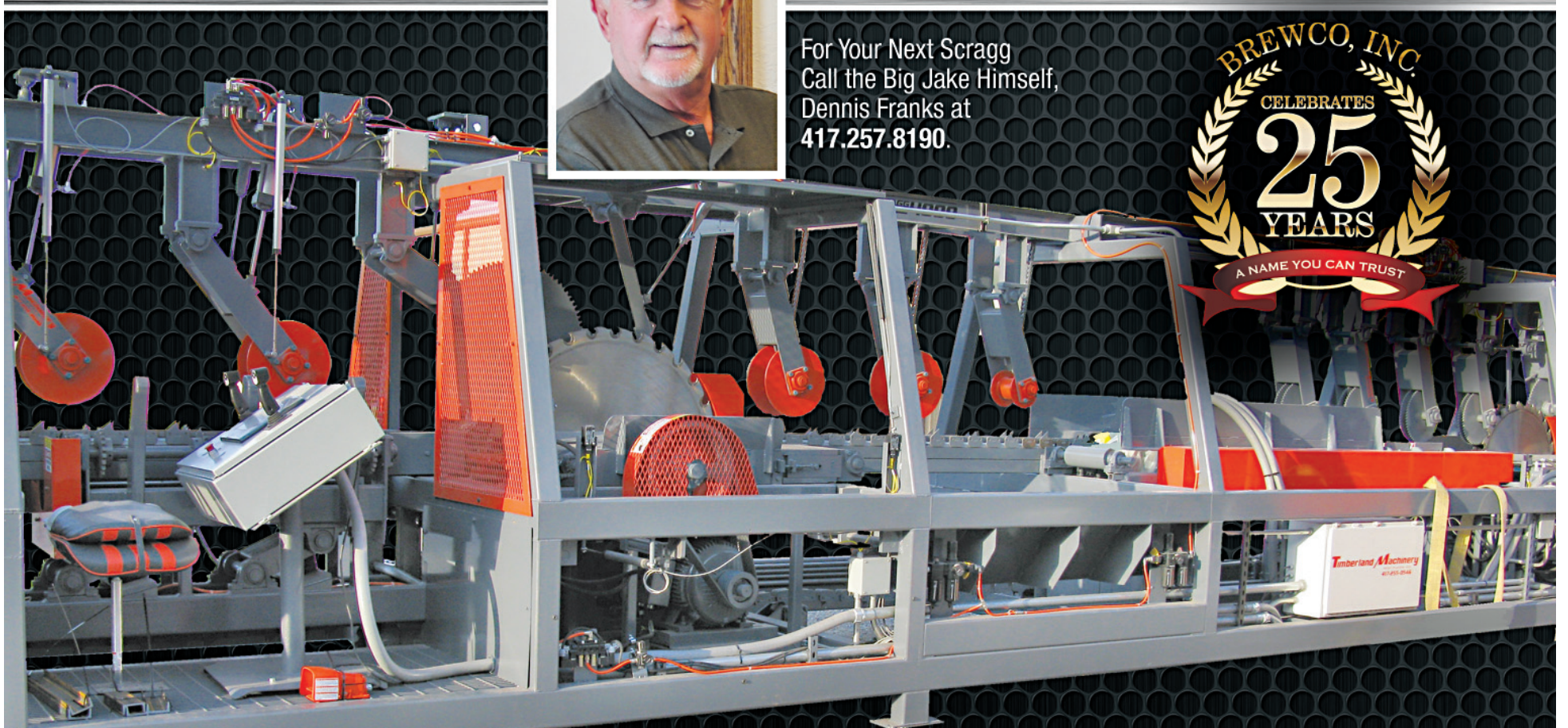

GET MORE CUT STOCK WITH THE
TIMBERLAND BIG JAKE 4000 SCRAGG
BY BREWCO

www.brewcoinc.com



607 Front St. • Central City, KY 42330

800.237.6880

Live Floor Trailers

From Pickup Truck Beds to 53'
BUY • SELL
RENT • NEW & USED
 Full Repair Service & Parts for
 Keith & Hallco Wet Kits, Hyd.
 Pumps, Valves, Hoses & More.

**If You're Thinking
 LIVE FLOOR —
 THINK FERGUSON FARMS!**

800-326-4919

Fax 574-453-3900 Cell 574-453-7120
 We Now Handle Western Belt Trailers!

Turn Your Surplus Equipment Into

CASH

*We pay top dollar for
 good used equipment.*

Go to our website for an
 up-to-date listing
 or call us at

800-241-8983



Ben Jones Machinery
 Div. of Dickert Enterprises, Inc.
 Industry's Most Trusted Source

UPDATED DAILY!

www.benjones.com

E-Mail: sales@benjones.com

PalMate[®] ERP

defining efficiency



Revolutionizing Recycling & Timber Operations



- Simplified inventory management
- Paperless BOL processing
- Streamlined production & delivery scheduling
- Track piece rates & productivity
- Forklift mounted tablet PCs and Bluetooth scanners

www.PalMateERP.com

Automated Machine Systems, Inc. | 877-267-8384



When You Buy Your Circular Saws From B.H. Payne – You've Bought The Best . . . **We Guarantee It!**

Here's What You Get With EVERY B.H. Payne Saw –

- Saws manufactured from only the Highest Quality Nickel Alloy Steel
- Each Saw Milled With State-Of-The-Art Precision CNC Milling Machine
- We Tension Your Saw to Your RPM **BEFORE** Leaving Our Factory
- Complete Guarantee of Your Satisfaction

We Are Hanchett Distributors

*We Manufacture & Sell Inserted Tooth Headsaws, Solid Tooth Saws, Inserted
 Tooth Cutoff Saws, Carbide Saws & Wide Band Saws. We Also Stock And
 Sell Bits & Shanks, Carbide Tips, Diamond Wheels, Knife Grinding Wheels,
 Saw Gumming Wheels, Knives, Babbitt & Babbitt Pots, "Lubie" Lubricants,
 Machine Parts for Various Filing Room Machines & More!*

B.H. PAYNE & COMPANY, INC.

P.O. BOX 90608, East Point, GA 30364
 404-761-8711 FAX 404-761-5398

"Traditional Quality Combined With Today's Technology"

Call 800-752-0627

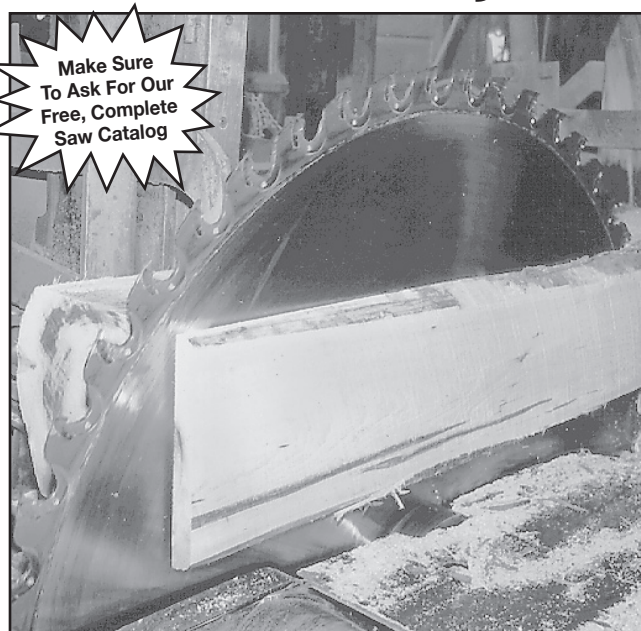

Make Sure
 To Ask For Our
 Free, Complete
 Saw Catalog

www.paynesaws.com



FOR SALE!

Georgetown Hydraulic Unit

LEERAY & LUKE HORTON
218-372-4232
 E-Mail: l1sales@frontiernet.net

Viking[®] Machine Parts For Sale

Call Jerry Lottes Parts Sales

(PH) **704-283-1920**

(CELL) **704-221-2205**

(FAX) **704-283-8716**

Jump Start Your Production With An A.I.T. HY 400 High-Speed Center Splitting Resaw

- Speeds up to 400 feet per minute
- Great for both center splitting and line bar cutting
- 50 HP Motors Power 2 12" .125 Kerf Saw Blades

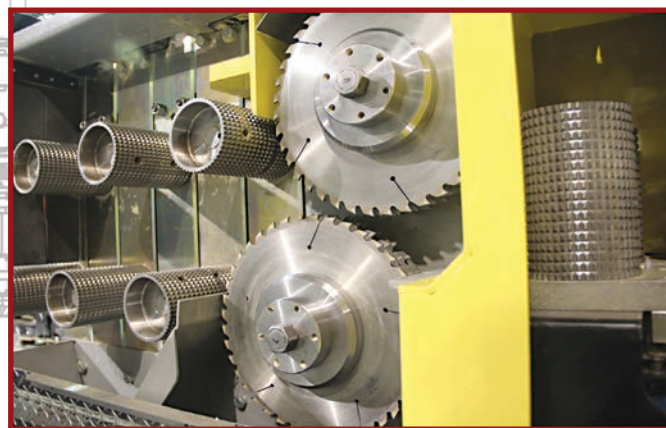
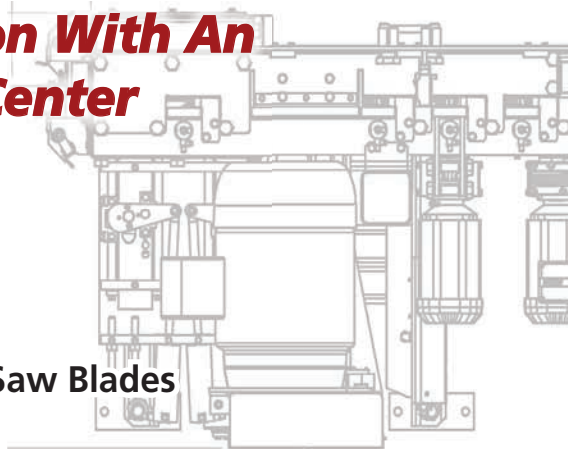

Increase Production and Reduce Labor With An M2L High-Speed Automatic Board Stacker

- Installs behind your resaw, notcher or chamfer
- Improve operator safety and save big on labor costs!
- Auto Tie strip option available • A Real Workhorse!



We're Ready To Help You Improve Your Bottom Line...

PALLET MACHINERY GROUP

6496 Landing Road / King George, VA 22485
 Phone: 540-644-9220 / Fax: 540-663-4081
 info@palletmachinery.com / palletmachinery.com

DEBARKER TEETH

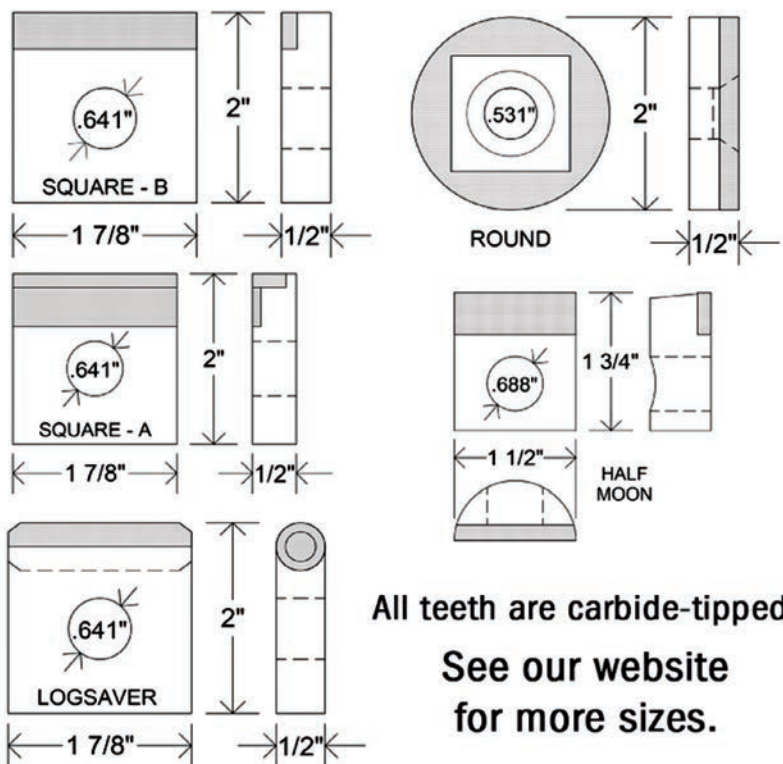

All teeth are carbide-tipped.
 See our website for more sizes.

Universal Wearparts, Inc.



142 Old Hwy. 98 West
 Tylertown, MS 39667
 800-647-8440 • 601-876-3442
 Fax 601-876-2342
 sales@universalwearparts.com
 www.universalwearparts.com

BANDSAW BLADES

We have the most popular sizes in stock & ready to ship from major manufacturers, including...

LENOX  **Wood-Mizer Blades**
 Your Leader in Blade Technology.

Welded to your lengths!

We also offer expert Sharpening Services, plus...

Gang • Edger • Scragg
 Trim • Split • Strob

...and just about any Custom Saws you need to keep you cutting longer...for less!

Call Marvin Miller for a quote
 231-924-5953 (fax) 231-924-6166

In Stock —
READY
 To Ship

Ask About
FREE
 Shipping!

MIDWEST
 SHARPENING SERVICE

The Morgan Line-Up!



Original Single Head Resaw

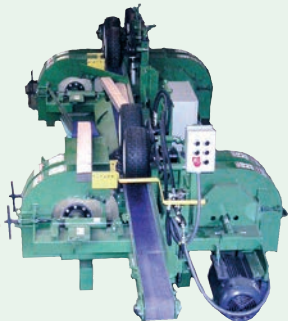

4-Head Resaw



Wide Cut Resaw



Multi-Head Trim Saw



Military Band Notcher

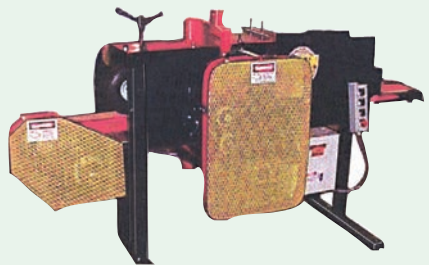

Board Duster



UNIVERSAL
MACHINERY SALES, INC.

Call Mona Tracy

855-298-8890

or 812-298-8090

sales.universalmachinerysales@gmail.com



ROTOCHOPPER
Inc.
Made In The USA

"Perfect In One Pass"®



**HIGH-VOLUME
WOOD GRINDING
SIMPLIFIED**



Follow Rotochopper on [f](#) [You Tube](#) [t](#) [+](#) [in](#) [✉](#)

320-548-3586 www.rotachopper.com

The proof is in the product

The Rotochopper FP-66 takes high-volume wood recycling to a new level, outperforming bigger grinders while minimizing fuel costs and maintenance downtime. Best of all, the FP-66 offers the same precision grinding built into every Rotochopper, so you get better mulch, fuel, or bedding, at a lower cost per ton or cubic yard.

How can the FP-66 maximize the value of your wood waste? Contact us to learn more.

3 Brand New GE 2002 Golden Eagle Chamfers



***In stock & ready
for immediate
delivery!***

Call **1-800-345-6516** or
visit www.brewermach.com

**Owner Retiring—
Business For Sale**

Profitable KY based manufacturer of Patented Saw Guides for band resaws and sawmills. Includes 2,500 sq. ft. building, complete machine shop, well established customer base, 4 U.S. patents & more!

Owner will train buyer.

Call 270-925-7127 for details.

BAKER Products



CUT MULTIPLES TO LENGTH IN ONE MOTION

DESIGNED

FOR

LOW LABOR!

AMBITRIM GANG TRIM SAW

FEATURES

Two to eight 18" diameter circular saws

Each saw is powered by a 7.5-HP electric motor

Saws can be set at equal or various distances from each other

Each saw head can easily be positioned independently

In one motion, saws cut the lumber into shorter pieces all at once

24"-Wide trough conveyor collects and discharges waste & end block material

RAW MATERIAL CAPACITIES

Width: 3/4 in. min-12 in. max

Length: 24 in. min-20 ft. max

Height: 1/4 in. min-3 1/2 in. max

OPTIONS

Board Singulator

Round Off-Stacking Turntable

Inclined Waste Conveyors

Self-Dumping Steel Hoppers

Infeed Unscrambler

800.548.6914

CALL US FOR MORE INFO

**BAKER
Products**

bakerproducts.net

info@bakerproducts.net

573.663.7711 800.548.6914

Like our page!

Your Log to Lumber Leader

Need Parts to Fit Your Morgan Saws?

MILITARY BAND NOTCHER



- 5hp motor
- Hydraulic adjustable feed
- Indexable carbide cutters
- Adjustable width & height
- Can custom build

Sawmill Supplies & Equipment, LLC

- Board De-Dusters
- Multi-Head Trim Saws
- Product & Waste Conveyors

Office: 318-994-2116

www.sawmillsupplies.net

E-mail: sawmillsupplies@centurylink.net

Call Mona Tracy
1-855-298-8890 (toll free)
sales.universalmachinerysales@gmail.com
universalmachinerysales.net

Still Building the ORIGINAL
Low Profile Single Resaw

THINKING AUCTION?

Call: 800-432-1922

WAUSAU/AUCTIONEERS

SALES CORP. P.O. BOX 1311 • WAUSAU, WI • 54402-1311

PH: (715) 536-1955 • (800) 432-1922

"Forest Products Specialists"

Your "Go-To" Source for Sawmill Supplies...

Wide Bandsaws * Shanks * Sawbits

Bartlett's Saw has supplied sawmills with better parts, supplies & service since 1978!
Rely on us to keep your mill running right.



Need Wide Bandsaws,
4-8" wide, in single and double cut,
1 3/4" to 2" tooth space.

**Guaranteed to run...
right out of the box!**



Our Shanks are so good,
they're guaranteed!

**If they split or crack,
we'll replace them for FREE!**



Check out
our Sawbits...
**The Eurobits
& Econobits**

Call us to place your next order...
800-566-0319

BARTLETT SAW SERVICE & SUPPLY

621 US 41A • Henderson, KY 42420

e-mail: eric@bartlettsaw.net



Every product we manufacture and sell
must meet our high standards
before being shipped.

**Guaranteed Products
+ Quick Delivery
+ Proven Experience
= Your Success**

**We also supply Edger Saws,
Slasher Saw Bits, Saw Grinders & Lots More!**

Ramp Up Your Firewood Business!



Model 2040xp2 – The Premier High Volume
Firewood Processor



Model 1610EZ - Joystick control, gas or diesel, live
deck or log lift, ultra mobile with integrated conveyor.



The Log Buster!

- Quarter Oversize Logs for further processing...
- 115 HP engine
 - Over 100 tons of brute splitting force.
 - Chip, Grind, Pulp, Firewood, Biomass & More!

MULTITEK NORTH AMERICA, LLC

Prentice, WI 54556-0170 USA • 800-243-5438 • e-mail: sales@multitekinc.com • www.multitekinc.com

Still Planning Your Next Mill Upgrade?

Complete Line of Meadows & Miner Edgers

From Portable & Board Edgers to 8" Combination Gang Edgers



from \$14,950

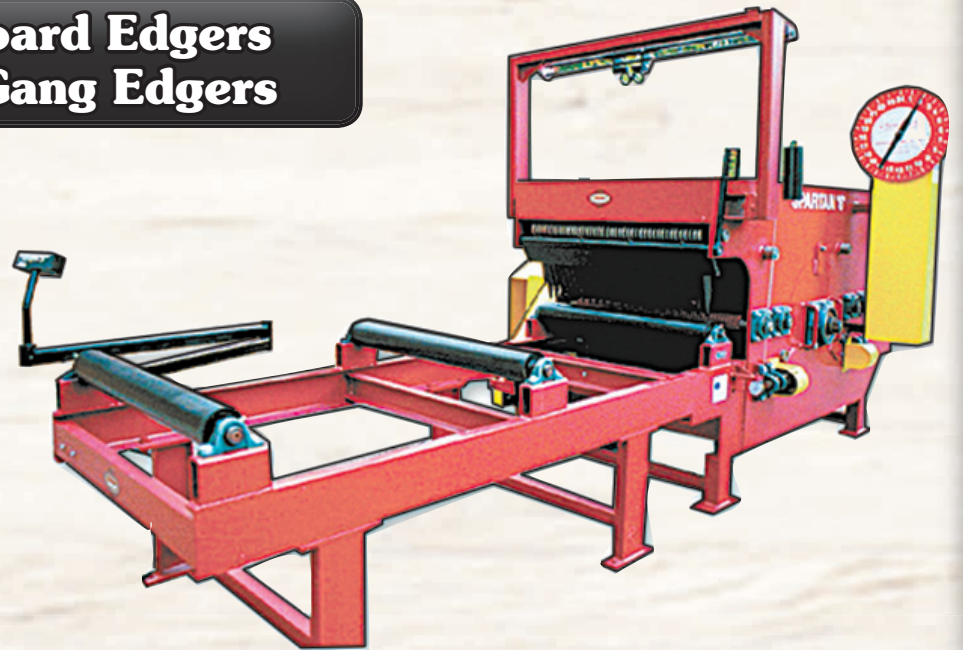

Don't Wait, Upgrade Now — Call Meadows Today!

Replacement Carriages and Complete Sawmills

Upgrade Your Production and Accuracy Quickly and Affordably...

NEW Center Dogging Series Carriage

- Handles a broad range of log lengths and diameters
- Cuts Grade lumber, cross ties, pallet material, long flitches and mat material

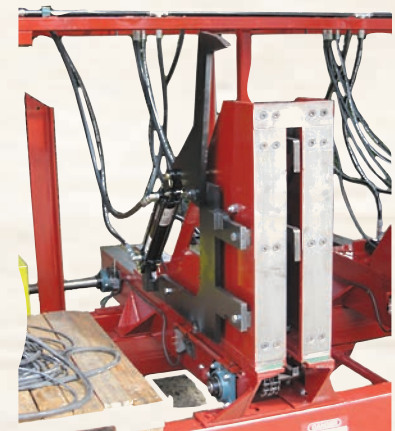

We've Streamlined Our Manufacturing and Increased Production To Save You Time and Money

Now's The Time To Save — AND Get Delivery **FAST!**

Custom Material Handling Equipment



Meadows Rollcase & Jump Transfer Decks

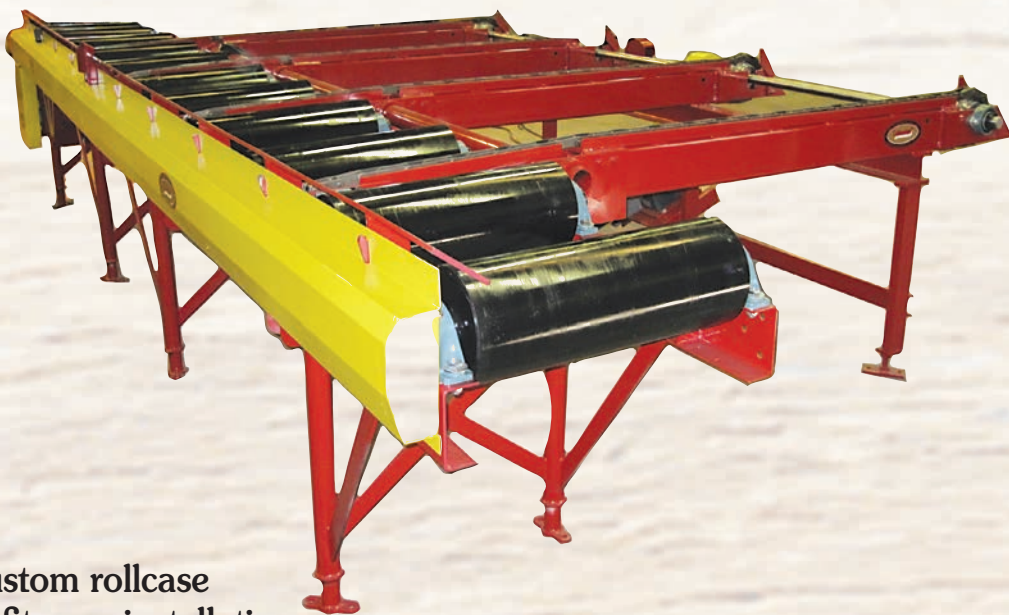

Custom rollcase to fit your installation
2-6 strand decks, length to fit, single or dual kick-off system for lumber, cant & waste sorting.
Plus **Green Chains & Grading Decks** — all **GUARANTEED** to ship within 30 days of drawing approval!

Meadows Log Deck



2, 3 or 4-strand, customized length and spacing to fit your application

Meadows Log Turner

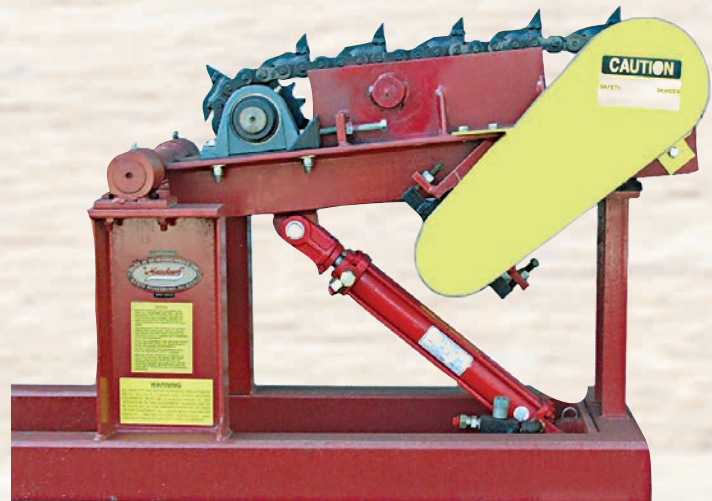

Hydraulic motor, 120H chain

Trusted by Sawmillers Everywhere — Since 1902

MEADOWS MILLS, INC. 800-626-2282



www.meadowsmills.com • sales@meadowsmills.com
1352 West D Street • North Wilkesboro, NC 28659

**THERE ARE MANY REASONS WHY YOU
NEED TO KNOW WHAT YOUR MILL IS WORTH**

EQUIPMENT & INSURANCE APPRAISALS • MARKETING PLANS • LENDERS

You have the right to choose your insurance appraiser!

See Our New Appraisal Website Today! www.kittrellappraisals.com
See Our New & Easy To Use Equipment Site! www.kittrellsawmillbrokers.com



**KITTRELL
APPRAISALS**
Forestry Equipment and Consultation
931-698-3342

**BE SURE YOU SPEAK WITH
JACQUELINE KITTRELL,**
OWNER, APPRAISER, AUCTIONEER,
REAL ESTATE BROKER, CAGA



info@kittrellappraisals.com • Fax: 931-231-1051 • Office: 931-797-6284 • Firm #5745

Bulk Box & Crate Care

*Our reinforcing corners & plates
are the answer for added*

- Protection • Durability
- Strength

- For New or Used items
- Apply by nail gun or hand
- 8 Sizes available
- Tough 20-gauge galvanized steel



MADE IN

U.S.A.



KLUG KORNER
800-471-5060 or
269-657-6858
www.klugkorners.com

**USED
EQUIPMENT**

We own what we advertise!
**New Equipment
Arriving Weekly**



PRS
PALLET REPAIR SYSTEMS, INC.

866-546-8864
<http://pallet-repair.com/viewused.asp>

K.M.C. Model 882HD Double Bandsaw

*We can provide the best machine
to meet your application
and production requirements!*



www.keystonemachinery.com Fax: 717-859-4979

- ✓ Self Adjusting Catty Track Hold Down System
- ✓ Harden & Baked Chrome Steel Paddle w/Lubrication System
- ✓ 18" Min. Length
- ✓ 3/8" to 6" High Material Climb from Blade Height — Optional 12" Climb
- ✓ Max Cut Height 8"
- ✓ Max Cut Width 8"

OPTIONAL: Digital Readout • Rubber Belt or Harden Steel Chain Feed • Floating Air Guide • Head Drive, Electric, Hydraulic or Lineshaft • Hydraulic Power Unit

717-859-4977

**KEYSTONE  MACHINERY
CORPORATION**

20 Cocalico Creek Rd. • Ephrata, PA 17522

Bandsaw Blades!
*Custom Welded – Immediate Shipment
Call for prices and sizes available.*

LENOX 

MORSE &

WOODMASTER
KASCO
SharpTech

SHARPENING SERVICES NOW AVAILABLE FOR 1", 1 1/4", 1 1/2", 2" BANDS

W-37 Wright Grinder
A compact, automatic grinder that is quick to set up and simple to operate. Precision cams produce excellent sharpness.





4800 SOLVAY RD - JAMESVILLE, NY 13078
1-800-952-8288
WWW.U-CUT.COM

Stop By and Visit Ben Jones Machinery's New Location

Ben Jones Machinery has moved and its new location provides lots of room for expansion away from the confines of the city of Columbus, GA but close enough for convenience.

The new physical address is:
**6475 Georgia Hwy 85
Waverly Hall, GA 31831**

And the new mailing address is:
**PO Box 207
Ellerslie, GA 31807**



Ben Jones Machinery
Div. of Dickert Enterprises, Inc.
Industry's Most Trusted Source

Ben Jones Machinery is the Wood Industry's Most Trusted Source for previously owned equipment. Please visit our new facility to discuss any equipment needs — *new, used or refurbished!* Call **1-800-241-8983** or visit www.benjones.com.

MULTI-HEAD END TRIMSAWS BUILT BY THE MORGAN FAMILY

PROCESSES BOARDS OR CANTS WITH PRECISION ACCURACY AT TOP PRODUCTION!

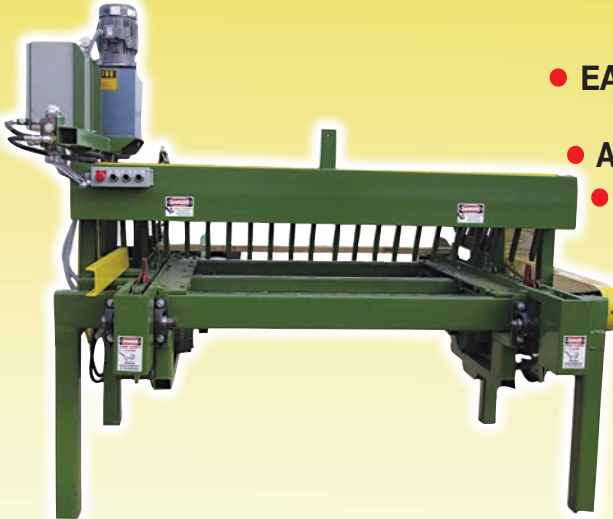

- AVAILABLE IN 2, 3, 4, & 5 HEAD MODELS
- EACH ONE EQUIPPED WITH 20" CARBIDE BLADES AND A 10 HP MOTOR PER HEAD
- ADJUSTABLE HEADS WITH VARIABLE FEED SPEED
- SPRING LOADED ADJUSTABLE HOLD DOWNS
- 5 HP HYDRAULIC UNIT POWERS CHAINS

» **OPTIONAL EQUIPMENT INCLUDES «**
 LARGER BLADES (22") AND MOTOR (20 HP)
 PLUS PRODUCT AND WASTE CONVEYORS



A family owned business. Builders of the ORIGINAL Low Profile Band Resaw.

Need parts for your Morgan Saw? We've got 'em!

**Sawmill Supplies
& Equipment LLC**
 Sarepta, LA
318-994-2116
 e-mail: sawmillsupplies@centurylink.net
 www.sawmillsupplies.net

Sales Office:
 Mona Tracy
Universal Machinery Sales, Inc.
1-855-298-8890
 e-mail: info@universalmachinerysales.net
 www.universalmachinerysales.net

Every Reputable Wide Band Supplier Offers...

- ✓ High Quality Swedish Steel
- ✓ 3" - 8" Band Width
- ✓ 16 to 20 Gage
- ✓ Double Cut Options
- ✓ Choice of Swage or Stellite

**BUT ONLY THE WOLVERINE
 BY MENOMINEE SAW GUARANTEES...**

- Cutting Edge Plasma Welds
- The Industry's Highest Cutting Capacity Band Saw
- Quick Delivery from our HUGE Inventory
- Fast Sharpening & Exchange Program to Keep YOU Running
- Competitive Pricing

And **ONLY** Menominee Gives You Everything You Need in a Wide Band Saw - Plus Expert Service from the Industry's Most Knowledgeable Staff.

Got a Wide Band Problem?
 Call Menominee Saw Today and You'll Learn Why More Mills Trust the Pros!



**TOLL FREE
 1-800-582-0470**

WWW.MENOMINEESAW.COM

Email: info@menomineesaw.com

NEW Chip Bins at Used Prices!

Having trouble finding good used chip bins? Save big \$\$ right now on New Bins from Crown Machinery...

Designed to fit **YOUR** application:

- ✓ Chips ✓ Dust
- ✓ Shavings
- ✓ Other Bulk Material



Our Bins are blowing the competitors' away — in Reliability, Durability and Cost!



CROWN MACHINERY

SCOTTSBORO, AL

256-218-3045

Fax: 256-218-3062

Sales, Service, Engineering, Installation & Removal of Equipment

www.CrownMachinery.us

harvey@crownmachinery.us

Cut Your Blade Costs – Keep Your Profits!



The Pallet Hawg Bandsaw Dismantler will pay for itself in no time in blade savings alone!

- One or Two Man Operation or Pallet Prep Saw
- The most versatile Pallet Dismantler Available
- Gear Reduction Drive for Long Blade Life
- Pneumatic Table Travels 5 1/4" to Allow for Easy Stringer, Block, or Deckboard Removal

NEW Power Feed Trim Saw

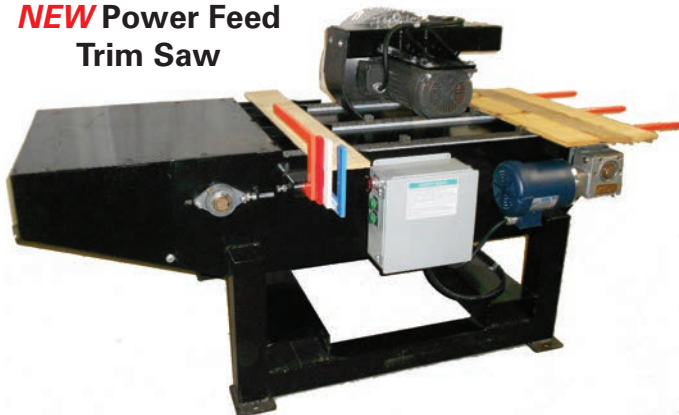

- Up to 12,000 trimmed boards per 8-hour shift!
- 4 adjustable board stops, set from 16" to 66" long
- No belts or pulleys to wear out or replace
- Handles stringer & deck boards up to 2 1/2" thick

NEW Pallet Hawg Up-cut Saw



- Trims both new & recycled lumber
- 10 HP, 18" blade
- 5" x 6" capacity

Change is good.

Get more blade life AND a smoother, more efficient operation.

Call Brad or Kent @
1-800-348-0703

www.noblemachine.com

NOBLE MACHINERY CO. INC.



FOR SALE!

Brewco E-Z Cut

LEERAY & LUKE HORTON
218-372-4232
E-Mail: llsales@frontiernet.net

FOR SALE

Stacker, Pendu Model 440 HD	#1515
Auxiliary Hydraulic Power Unit, Model 1030	#1525
West Plains 4 Strand 2080 Chain Deck	#1406
West Plains Rollcase	#1398 #1405
Skate Roll Deck, 20' long 2-strand w/ stops	#1494
Rollcase 15' long x 14" wide w/pillow block bearings	#1504
Pendu Model 1600 3 Strand Green Chain	#1027
Pendu Green Chain	#1270
Lumber Transfer Deck, 26' long 2-strand C55B rooftop chain	#1498
Lumber transfer deck, 19' long 2-strand C55B rooftop chain	#1495
Lumber Hoist / De-stacker, 4,000 lb capacity	#1499
10' long, 5" wide driven Roll-case w/ 2 driven top pinch rolls, air actuated	#1496
78 Chain Deck, 3-strand 10' long w/hyd. drive	#1502

For complete details call
800-233-0471
Email: info@pendu.com
www.pendu.com

CEMARLIGNE

NEED A LASER?

SEE PAGE 44...

CEMAR ELECTRO INC.
THE LEADER IN LINE LASER TECHNOLOGY

PRINTERS FOR THE PALLET INDUSTRY

444SM-PALLET PRINTER

- Cost-effective alternative for placement of HT, IPPC information on each and every pallet.
- Capable of mounting to automated pallet machines.
- Saves time and money compared to manually hand stamping or spraying information on pallets separately.
- Velcro backed hubs allow quick and easy changes to information placed on pallets.
- Spring tension maintains contact and even printing on every pallet.
- Fully adjustable.
- Permanent stamps and information.
- **7 different colors of ink and ink rolls available**

CLAUSSEN ALL-MARK INC.
8795 Grissom Pkwy. - Titusville, FL 32780
PHONE: 800-252-2736 FAX: 321-607-5071
Email: sales@claussenallmark.com • www.Claussenallmark.com

Used & Reconditioned Equipment In Stock!



In Stock! Used/Reconditioned Baghouses, such as this Torit 276RF 12—complete with rotary airlock & support steel with capacities from 5,000 CFM to 70,000 CFM depending on requirements. We stock a wide variety of replacement parts for baghouses: filter bags, cleaning head blowers & components, level detectors, rotary airlock speed reducers & drive components.



Used/Reconditioned Fan Packages Material handling or air handling fan, motor, drives, base & electrical (if required); 4,000 CFM to 60,000 CFM capacities available; Reconditioned units receive new paint, bearings & thorough check up!

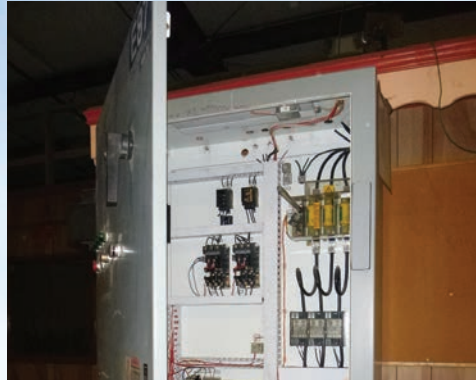

In Stock! A wide variety of used electrical control equipment including disconnects, magnetic starters, solid state soft starts, used spark detection/suppression panels, spark detection/suppression detectors & spray nozzles.



Used Woodworking Machinery, including Fletcher banders, CNC routers, saws, wood grinders/hogs, conveyors, etc.



Air Systems Mfg.
OF LENOIR, INC.



Check out our website at:
www.airsystemsmfg.com

(828) 757-3500
Fax (828) 758-5178

2621 Hogan Dr.
P. O. Box 1736 • Lenoir, NC 28645

STRAIGHT TALK & SAWMILLS

That's What You Get at Sawmill Exchange!

OVER 800 LISTINGS!

Band or Circular Sawmills, Portable or Stationary, Manual or Auto, Hobbyist to Professional Models.

Plus, the Support Equipment to "Make Your Dream Mill a Reality."

Like Resaws, Edgers, Planers, Dry Kilns, Chippers, Loaders, Firewood Processors and More!



1985 Sanborn Min Max High Production Band Mill

Complete upgrade performed in Sept. 2015 including new computer networks, new 30 HP 3 phase electric motor, new hydraulic valves, and new feed rolls. Includes 3 strand 20' log deck with stop & load, 2 extra blades. Uses 6" bands. Produces about 7,000 bf/day. Kept under cover and is portable. Cuts up to 20' length.

\$68,000

Location: Maine
Ad#: 17009

Call Today to Sell Your Mill
or Receive Current Inventory Listings!
Or Go Online —

www.sawmillexchange.com

SAWMILL EXCHANGE

800-459-2148

713-729-6455 (713-SAWMILL) • Fax 205-453-4262

Make More Money From Your Waste!

Alternative Energy Is The Way To Go Today!

Expand Your Business With A New Line of Pellet Mills and Complete Pelletizing Systems from Crown Machinery.

As one of the largest growing sources of alternative energy in the world, pellet mill facilities are popping up all over the globe; We can help you join this growing market!

Why Pay More?
Buy Direct From Crown
and SAVE 25% or More!



- Maximum Efficiency & Productivity • Warranty & Turn-Key Service from Crown
- Handles All Types of Material Found in Bio-Fuel and Feed Markets



CROWN MACHINERY

SCOTTSBORO, AL

256-218-3045

Fax: 256-218-3062

Sales, Service, Engineering, Installation & Removal of Equipment

www.CrownMachinery.us

harvey@crownmachinery.us

STREAMLINE LASERS



OUR MOST POPULAR ELD-15

IS THE INDUSTRY STANDARD FOR LONG LIFE & DURABILITY

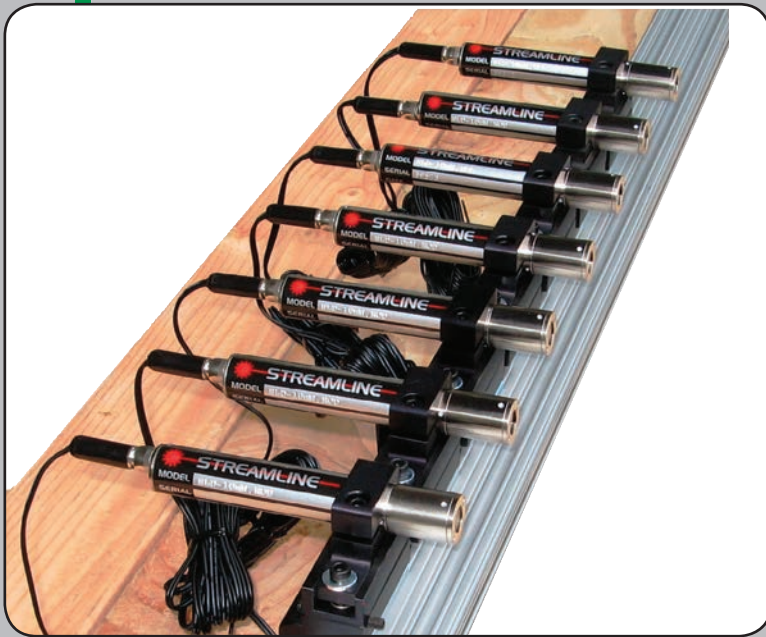

Get It All

- Cost Less Up Front!
- Longer Useful Life (*means it costs EVEN LESS!*)
- Superior Components
- Standard & Premium Grades Offered
- Straight Talk – we ONLY sell you the laser YOU NEED!
- Two Year Warranty on Most Lasers Sold
- Thinking **GREEN** Lasers? Call to Get the FACTS FIRST!

The EGL Has Landed... Again!
The New EGL Series of
Green Diode Lasers

- * *Economical*
- * *Precise*
- * *Enhanced Visibility*



Before you Buy ANY LASER –
For ANY Forest Industry Application
Call Ellison Sales FIRST!



Shift Kits Available for Moveable Saw Applications

The Laser Choice Since 1972 – Over 40 Years Of Laser Manufacturing and Straight Talk



ELLISON SALES
Toll-Free: 888-244-0161
E-mail: dan@ellisonsales.com
www.ellisonsales.com

Computer Networks for **ANY** Set Shaft or Linear Position Carriage

- ✓ Direct replacement for Silvatech
- ✓ 54 programmable set options
- ✓ Preset stack function
- ✓ Easy to read touch screen for operation, set-up and diagnostics
- ✓ Designed to run great in harsh environments
- ✓ Works on Cleereman air set carriages
- ✓ Other items include light curtain & 3D scanning, linebar resaw networks, vertical and flat edger networks

Setup		4.1/8	5.55/64	Mem1	Mem2
Top	Clear	1.1/2		0	0
7.1/8	12.1/8			SetQ	1
6.1/8	11.1/8			7.1/8	
5.1/8	10.1/8	2:35 PM		6.1/8	11.1/8
4.1/8	9.1/8	Ok		5.1/8	10.1/8
3.1/8	8.1/8	3/32		4.1/8	9.1/8
		0		1.1/8	8.1/8
Shim	Fill	Save	Stack	Clear	

Eliminate the guess work – Call today!

800-582-0470

e-mail: John@menomineesaw.com

MENOMINEE SAW

MASS Saver Computer Networks... Reliable and Affordable!

Need Money Now?

PROBLEM:

You give your customers 30 days to pay...

SOLUTION:

GET YOUR MONEY NOW and still offer credit terms to your valuable customers!

Here's How It Works:

- Invoice today - Get paid today up to 80% on your invoices. The other 20% is paid to you, less our fee, when your customer pays the invoice.
- Flexible fee structure
- You do not incur debt!! This is not a loan
- No application fee and no long term commitments
- Grow your business with the increased cash flow
- Take cash discounts offered by your vendors

Turn Your Invoices Into IMMEDIATE CASH!

Working Capital From A Company That Works For You!



FACTeON
ONLINE FACTORING

Call Steve Morgan today at **888-673-3863** (fund)

Apply online at www.facteon.com

UNBEATABLE PRICES ON NEW & USED MATERIAL HANDLING EQUIPMENT!



Refurbished 62 Unit Bin



New Single, Dual or Triple Truck Loading System



Assorted Cyclones



New & Used Belt Conveyors



Kockums 10' x 10' Shaker Screen

COMPLETE PACKAGE DEALS!!

- COMPLETE 4-HEAD BLUE DIAMOND DUAL BOX SHAVINGS MILL - 75+ Yds per hour. Includes Shaver, Dryer System and all components through Verville 3-station Bagger
- NEW Complete Pellet Mill Lines
- NEW Chip Bins
- NEW Hildebrand Kilns



Refurbished 30 Unit Bin



12' x 48' MEC Triple Pass Drum Dryer



Dry Kiln & Hurst Gas Boiler 20,000 board ft. per side!

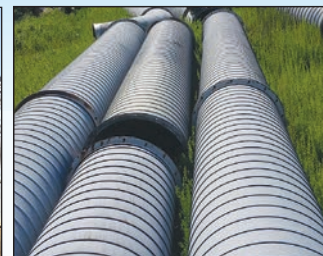

Assorted Blow Pipe

Need Something Else? Call Us... If We Don't Have It, We'll Find It!

www.CrownMachinery.us

harvey@crownmachinery.us

Kimber Wood Shavers are distributed by Crown Machinery, LLC



CROWN MACHINERY

SCOTTSBORO, AL

256-218-3045

Fax: 256-218-3062

Sales, Service, Engineering, Installation and Removal of Equipment

Superior Drying for Grade Lumber AND Pallet Treating... BOLDESIGNS Gives You More Options and Better Performance!



Smooth interior walls/ceiling for even air flow
Wall-to-wall heating coils for even heat distribution
Solid cast reversible aluminum fans for better air flow
Automatically raised baffles
Patented Wet Air™ Venting for fuel savings of 25-30%!



All aluminum construction
Non-corrosive mineral wool insulation
Customized size & shape
Easy operation, touch screen
Windows™ based controller
Techs onsite to train your operator
Easier in/out open chamber access

Call **BOLDESIGNS** at **1-800-645-7001**
P.O. Box 1586 Lenoir, NC 28645

See more at
www.drykilnboldesigns.com

Don't Wait... Let Us Solve Your Drying Issues Today!

Heat Treat Stamps



Branding Irons and Hot Stamps
Propane or Electric
ISPM 15 Compliant
also Available For Nailers



BrandNew Industries, Inc.
(800) 964-8251
BrandNew.net

Stock Your Sawmill With The Best Saws — Since 1890!

See our web specials at:
www.paynesaws.com
800-752-0627



High Performance Wood & Bark Hogs

Montgomery hogs are engineered to require less horsepower and produce consistent end product with a minimum of fines



KC Punch-and-Die Hogs



T3 Punch-and-Die Hogs



Swinghammer Hogs



LRW-J Slow Speed Grinders

- ✓ Lower Input Cost for Power
- ✓ More Efficient Burn in the Boiler
- ✓ Higher Quality of Mulch
- ✓ Rugged Construction
- ✓ Straightforward Maintenance

Protect your investment with parts engineered to perform.

MONTGOMERY

INDUSTRIES INTERNATIONAL

2017 Thelma Street • Jacksonville, Florida 32206
Ph> 904.355.5671 • Fax> 904.355.0401
www.montgomeryindustries.com

Honeyville DUST COLLECTION

Quality & Tradition.... Since 1951

See us at:
Feb 19-20 Buckeye Tool Expo Dalton, OH
May 13-14 East Coast Sawmill & Logging Richmond, VA
Aug 24-27 International Woodworking Fair Atlanta, GA



single, double & triple trailer loadout



36 models of Cyclone Collectors

- Flanged welded pipe & elbows in 18ga. up to 1/4" HR
- Galvanized lock-seam pipe in 26 ga. up to 16 ga.
- AR-400 steel available for green lumber applications



Flex Tip Rotary Airlock
5-models: 8" to 24"



Material Handling Fans
500 to 58,500 CFM



Round and Square Pulse Jet Baghouse Filters from 1,000 to 61,000 CFM



Honeyville Metal, Inc.

4200 S 900 W • Topeka, IN 46571 www.honeyvillemetal.com
Phone (800) 593-8377 • Fax (260) 593-2486

NEED TO REDUCE LABOR AND INCREASE YIELD?



HAS SOLUTIONS FOR YOU

FROM
CUTUP
SYSTEMS

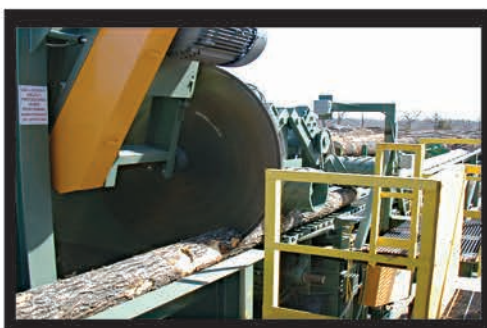

AND
EVERYTHING
IN
BETWEEN



TO
STACKING
SYSTEMS

YOUR ONE STOP FOR QUALITY CUSTOM SAWMILL EQUIPMENT SINCE 1965

DON'T WAIT, GIVE US A CALL AT 478-252-5885

EMAIL: INFO@COOPERMACHINE.COM WEBSITE: WWW.COOPERMACHINE.COM

YOUTUBE: WWW.YOUTUBE.COM/COOPERMACHINECOINC

Fast, Durable, Productive Machinery For Pallet & Lumber Mills - Recycled & New Producers!

27 years Building Dependable Machines Heartland Fab. & Machine



B54E
Band Saw
Pallet Dismantler



STS10
Single
End
Trim Saw

Band saw pallet dismantlers, single end trim saws, multi-head trim saws, chop saws, disc-type pallet dismantlers, conveyors & conveyor systems, rotary tables and custom machinery.



Heartland Fabrication & Machine Inc.

Pulaski, WI Phone: 920-822-2215, Phone/Fax: 800-422-2215

www.heartlandfabandmachine.com • e-mail: heartlandfabandmachine@gmail.com

1-920-822-2215

Thinking Auction? DON'T GAMBLE!



ASSOCIATED AUCTION & Liquidation Co. IS THE RIGHT CHOICE!

Upcoming Auctions

<p>✓ March 10, 2016 (Thursday) 9 AM PT Forks, WA Formerly Allen Logging Sawmill, Planer Mill, Rolling Stock (Rolling Stock will be sold promptly at 12 Noon PT)</p>	<p>✓ March 19, 2016 10 AM CT Tomahawk, WI Nokomis Sawmill Scragg Mill, Resaw Operation, Rolling Stock</p>
--	---

**To Schedule a No Obligation
Consultation Call 800-598-3651**

PO Box 147, Clarksburg, TN 38324
Fax: 731-986-4529
www.associatedauctioncompany.com
sales@associatedauctioncompany.com



**Morbark MorPack w/Topsaw
& Meadows 2-Saw
Vertical Edger**

All electrical & disconnects included.

Location: California
Ad #: 16664

\$275,000

SAWMILL EXCHANGE
800-459-2148
www.sawmillexchange.com



SAVE \$\$\$

Our metal connector plates repair wooden pallets to a like-new condition. High quality, superior strength.



Ready to Ship!

PALLET REPAIR SYSTEMS, INC.
866-546-8864
Fax: 217-291-0008
www.pallet-repair.com/alp

CEMARLINE®

www.cemarelectro.com



CEMAR ELECTRO INC.
LASERS

GREEN!
5,15,30,50mW

- Industrial Strength
- Patented Linear Optics
- 48-Hour Repair Service
- Powershift™ Technology
- 2-year Warranty

Call Toll Free Today:
1-800-298-5273
Fax: 518-298-2927

5-30 mW RED LASER



G401 Sawmill Networks

2 YEAR WARRANTY

Compare prices and features. Our G401 Networks is the ultimate saw controller, packed with features, rugged, and built to last with non-proprietary components. Call us or visit our website for more information on our other sawmill control solutions: Edgers, Trimmers, Resaws, Scraggs, Tallies, Customized Systems and more!



Thomas Industrial Controls
www.thomasic.com 1-866-899-0495



The Leader In Chain Bar Repairing Since 1961

🎉 : Celebrating 50 Years : 🎉

Cut off bars for bundled lumber and cut off applications
We repair all types of bars and offer custom manufactured bars for all aspects of the wood products industry.



CHAIN BAR REPAIRING

CALL TOLL FREE
1-877-SAW BARS (729-2277)
or 503-774-4266 www.chainbar.com
Email: chainbar@comcast.net

BILL DAVENPORT • 5425 SE Johnson Creek Blvd. • Portland, Oregon 97222

CALL FOR PRICE QUOTES

Pallet Assembly Solutions from Mona Tracy...

Thinking About Buying A Nailing System? Universal Gives You Choices...

**This Nailer Is Your
"NEXT STEP UP"
In Production!**

**New Universal
In-Line Nailing System!
Serious Stringer Pallet Production
Is Now Available...**

- Produces 1,200 pallets per day
- Eliminates use of hydraulic fluid for operation
- Up to standard size 64"x 84" pallet as its basic design (other size options available)
- Less air controls • Two or three man operation
- Fully automatic stacker • PLC controlled, no pneumatic switches



**Block Pallet
Attachment
Available!**

**The
"NAIL EASE"**



- Assembles all size pallets (up to 50" x 50") with easy adjustments
- For New & Recycled lumber

**Nailing
pallets has
never been
easier!**

**NAIL-MATE II
Flat Table/Manual Handling
Nailing Machine**

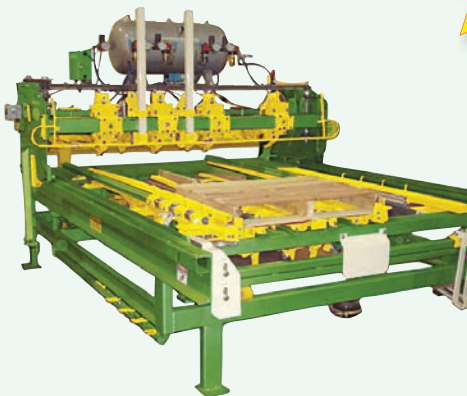

**Fast, Easy
Assembly
of Any Size
Pallets!**

**NAIL-MATE
Automatic Nailing Jig**

- 12 years proven in the industry
- Auto firing, one-man operation
- Handles 3 or 4-stringer pallets, wing pallets or others up to 56" x 50" at a rate of 1-2 pallets per minute!



**The "REVO" Revolving
Work Station**

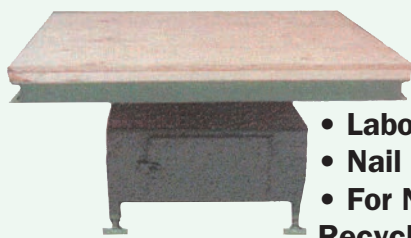

- Labor Saving!
- Nail at your own pace
- For New Pallets, Recycling or Reman jobs

**The
Nailing
Station**



- Hold down system and swivel turn over for nailing both sides
- Simple Construction of large, heavy & hard-to-handle sizes (any length possible)

**JAM DOCTOR
• Clears Nail Jams!**



UNIVERSAL
MACHINERY SALES, INC.

Sales: Mona Tracy
Universal Machinery Sales, Inc.
Toll Free 1-855-298-8890
e-mail: sales.universalmachinerysales@gmail.com
www.universalmachinerysales.net

**Leasing
& Financing
Available**

Why Wait? Get It Now... At the **BEST PRICE!**



Rotochopper EC124
(2) Available



Brewco Band Head Rig



Rebuilt Salem 6' Band Head Rig



Precision 48" Chip Pack (Like New)



Newnes 10" Thin Kerf Gang



Baker Deduster



McDonough Left Hand 62" Air Strand



G. Wine (PMG) M2L Board Stacker



120" Double End Notcher



Baker 2 Head



KM 16 5 Head Trimmer



Brewco B800 w/Return



Brewco Infeed & Unscrambler



Factory Rebuilt Pendu 2400



Brewco 5 Head Resaw

OTHER ITEMS NOT SHOWN

- Morbark 48" Chip Pac
- West Salem 2822 Horizontal Hog
- Nicholson 104" Chipper
- 30 Bay J Bar Bin Sorter
- Newnes 20' Optimizing Trimmer
- Newnes Optimizing Edger
- Brewco 800 4 Head

- SCMI Compact 22 Moulder
- Timberland Deduster
- Overhead Truck Loading System
- MEC 1035 Triple Pass Dryer
- Brewco EZ Cut 4 Head Resaw
- MEC 1240 Triple Pass Dryer
- Precision 66" 6 Knife Chipper
- Several Chip Bins

LPS EQUIPMENT & ACQUISITION CO.
731-986-4351 • Email: sales@lps-inc.com

800-598-3651
WWW.LPS-INC.COM

Go to www.lps-inc.com and select **SPECIALS** for up to the minute listings!

Is It New or Arkansas Electrical Outlet? Only Your Accountant Knows For Sure!

OUR COMPREHENSIVE RE-CONDITIONING PROCESS INCLUDES:

- Disassemble & Clean
- Repair & Powder Coat Enclosure
- Totally Rewired
- Rebuild or Replace ALL Components
- Thorough Pre-Shipment Testing

The SHOCKING PART... YOU STILL SAVE UP TO 50% AND AEO Provides a 1 Year Warranty!

**Get It Now!
Get It For Less!
Get A Warranty!**

**CALL ARKANSAS ELECTRICAL OUTLET
888.374.2364**
Or Visit www.AEOGlobal.com

- Huge Inventory of:
- Motor Control Centers
 - MCC Buckets
 - Circuit Breakers
 - Transformers
 - Switch Gear
 - Soft Start Starters
 - Custom Control Panels



PRECISION-MADE SHAFTS FOR ALL MONTGOMERY HOGS & BLO-HOGS



ELLISON SALES, INC.
PORTLAND, OREGON
888-244-0161
dan@ellisonsales.com

Crosscut Unit Saws

See in action at www.ptmi.net

Quick, Accurate Processing --- Low Labor!



SMALL EUROS WANTED

31.5 x 47.5 - Full & Half Loads
Ruma Pallet
617-455-1184
e-mail: pallets@rumas.com

Need Parts to Fit Your Morgan Saws?



Sawmill Supplies & Equipment, LLC
supplies, parts and more!

Office: 318-994-2116
www.sawmillsupplies.net
E-mail: sawmillsupplies@centurylink.net

Still Building the ORIGINAL Low Profile Single Resaw

**The Original
Lake States "Premier"
Industrial Hardwood
Lumber Producer**



**AJD
Forest
Products**



**Pallet operations
have relied on us for
High Quality Lumber
for over 40 Years!
.... 1/2 "thru 8/4"
pulled to length
Lumber, Timbers & Cants**

*If you want a good product to process
in your plant and not have to deal
with lots of waste...*

**Call us today!
989-348-5412
www.ajdforestproducts.com
info@ajdforestproducts.com
Four Mile Rd. • Grayling, MI 49738**



SIMONDS[®]

PreSharp[™]

IS REAL SHARP!

PreSharp[™] IS AVAILABLE IN 3 WIDTHS:
• 1" OS wide • 1-1/4" wide • 1-1/2" wide

**Not all Ground
Tooth blades are
created equal!**

PreSharp[™]
SQUARE FACE BLADE DETAIL

Simonds PreSharp[™] blades have a unique, square-face cutting edge.

Conventional blades, even "ground tooth" types, have a twist on the face. This twist pushes saw dust to the sides of the blade, potentially causing poor tracking and dust spillage.

BANDSAW BLADES FOR ALL CUTTING APPLICATIONS

MAKE SIMONDS YOUR SOURCE FOR PORTABLE SAWMILL BLADES, FIREWOOD PROCESSING SAWS, SAW TEETH, & CHIPPER KNIVES.



SAWBLADES AND TEETH FOR FIREWOOD PROCESSING SAWS



CHIPPER KNIVES



INSERTED TOOTH SAWS

CALL FOR THE DEALER NEAREST YOU



1-800-426-6226



www.simondsinternational.com
Simonds International Fitchburg, Mass. USA

Attention Southeast Pallet Operations -

We offer Pallet Cut Stock delivered to your plant. Reasonable prices - Reliable delivery!

We also supply:



Magnolia Forest Products, Inc.
P.O. Box 99 • Terry, MS 39170 • Fax: 601-878-2589

- Crating products
- Packaging products
- Treated Materials
- SYP Plywood, OSB
- SYP Lumber
- Particle Board, MDF
- Hardwood Lumber
- Import-Export wood products

**Call 800-366-6374
or 601-878-2581**

Actual Size Handheld Super-Size Performance

For Lumber, Logging, & Cruising, switch to the handheld that consistently out-performs all the others.

For more info and a risk-free demo call **888.520.1951**

Or go online at www.eLIMBS.com

Parts & Repairs For Your Nailing Machines...

Pallet, Wooden Box, Cable Reel & Tackless Nailers
Specializing in FMC, Doig
— even older Morgan & Gage machines!

F.W. Morse / PVI Co. • 518-747-2017
www.nailingmachineparts.com
e-mail: morgangageparts@gmail.com

West Salem 2822 Horizontal Hog

LPS EQUIPMENT & ACQUISITION CO. **800-598-3651**
731-986-4351 | sales@lps-inc.com **WWW.LPS-INC.COM**

Need Parts to Fit Your Morgan Saws?

Sawmill Supplies & Equipment, LLC
supplies parts and more!

- Board De-Dusters
- Multi-Head Trim Saws
- Military Band Groover/Notchers
- Product & Waste Conveyors

Tell us what you need. We'll build it... the RIGHT way!

Office: **318-994-2116**
www.sawmillsupplies.net
E-mail: sawmillsupplies@centurylink.net
Sarepta, LA

Sales:
Call **Mona Tracy**
1-855-298-8890 (toll free)
sales.universalmachinerysales@gmail.com
universalmachinerysales.net

Still Building the ORIGINAL Low Profile Single Resaw

See For Yourself... **TIMBER WOLF** Band Mill Blades

A New Way to Buy your Blades at

timberwolfbandmillblades.com

THE LOG STREET JOURNAL

"Your trusted authority for sawlog marketing information"

We Specialize In Current Log Prices!

Hard & Softwood Log Prices
Log Prices For New England, NY & PA
Veneer Logs | Grade Logs | Pallet Logs

www.TheLogStreet.com

Celebrating **26 YEARS!** 1989 - 2015

The Log Street Journal | P.O. Box 82 | Deerfield | New Hampshire 03037 | 603-463-1449 | sawlogs@outlook.com

ATTENTION SAWMILL OWNERS:

WOODMIZER LT300, LT70, WM4000, WM3500 BAKER 36 & COOKS AC36

New and current customers who see this add take advantage till the end of May 2016. Time to stock up! Why pay more?

PRICES INCLUDE SHIPPING*

- 13'2 (158") x 1.25" x 042 = \$13.40
- 13'2 (158") x 1" x 035 = \$9.99
- 15'4 (184") x 1.5" x 042 = \$19.75
- 15'4 (184") x 1.5" x 050 = \$21.25
- 15'4 (184") x 1.5" x 055 = \$22.75
- 16'4 (196") x 1.5" x 042 = \$20.50
- 16'4 (196") x 1.5" x 050 = \$22.15
- 16'4 (196") x 1.5" x 055 = \$23.60
- 17'1 (205") x 1.5" x 042 = \$21.00
- 17'1 (205") x 1.5" x 050 = \$22.75
- 17'1 (205") x 1.5" x 055 = \$24.25
- 17'4 (208") x 1.5" x 042 = \$21.25
- 17'4 (208") x 1.5" x 050 = \$23.00
- 17'4 (208") x 1.5" x 055 = \$24.50

LENOX 

Wood-Mizer

**DAKIN
FLATHERS**

SIMONDS



**SOUTHEASTERN
METALS**

**NATIONWIDE
SHIPPING**

678-207-8550 • www.semetals.net

*Prices are for a full box of blades (70lbs of steel). Example: 13'2 x 1.25 is packed 30 to a box to receive the promo price of \$13.40 each.

The Richmond Show

EXPO RICHMOND 2016

Richmond Raceway Complex * Richmond, Virginia
 Friday May 13th 8:30a.m. until 5:00p.m.

and

Saturday May 14th, 2016 8:30a.m. until 3:00p.m.

The 35th East Coast Sawmill and Logging Equipment Exposition



will be 2016's largest collection of sawmill, logging, biomass, pallet and related manufacturing equipment, supplies and services in the Eastern United States. More than 300 exhibiting companies and thousands of forest products industry people will convene for the 35th Richmond Show. The newest and most advanced machinery, equipment and technology in the industry will be on display. There will be acres of active hands-on machinery and equipment demonstrations outside, plus hundreds of indoor displays of new products, methods, technology and trends. Examine and compare products or services before making your purchasing decisions to improve the efficiency - and profitability - of your operation. Please fill out and return the pre-registration form below to the exposition office by April 1, 2016. Confirmations will be emailed to all pre-registered individuals by

May 4, 2016. If no email address is provided, hard copy confirmation will **NOT** be provided due to increased processing, handling, and mailing costs. There will be a **\$10.00** charge for those who register **on-site**. Pre-registrants receive HALF-OFF the on-site registration fee. All registration fees will be collected at EXPO Richmond entrance - **DO NOT SEND MONEY** with this form. Registration entitles attendees admission to BOTH EXPO 2016 exhibition days. Virginia Forest Products Association (VFPA) members who pre-register will **NOT** be assessed registration fees. For further information on becoming a VFPA member or regarding EXPO Richmond 2016, please call **(804) 737-5625**. Don't miss this opportunity to invest in your future.

EXPO RICHMOND 2016		Co-sponsored by Virginia Polytechnic Institute & State University Cooperative Extension and Virginia Forest Products Association
Return by April 1, 2016 to: EXPO RICHMOND 2016 • P. O. Box 160 • Sandston, VA 23150-0160 Please fill out completely and legibly. Incomplete or illegible forms can not be processed. Only industry personnel should complete this form. Please copy this form for additional registrants. Spouses and children under 18 DO NOT complete this form. EXHIBITORS: Please contact Show Management for registration forms.		
Your Name: _____	Nickname: _____	
Company: _____	Title: _____	
Address: _____		
City: _____	State: _____	ZIP: _____
Telephone: _____	FAX: _____	
E-mail: _____	Country (if not USA): _____	
PLEASE CHECK ALL CLASSIFICATIONS OF INTEREST: -- (You must check at least one)		
<input type="checkbox"/> Sawmilling	<input type="checkbox"/> Logging	<input type="checkbox"/> Pallet Production/Recycling
<input type="checkbox"/> Equipment Manufacturer	<input type="checkbox"/> Plywood/Panel	<input type="checkbox"/> Dealer Sales
		<input type="checkbox"/> Paper/Pulp
		<input type="checkbox"/> Other (Please Specify) :
Pre-registration allows entrance to EXPO 2016 at HALF-PRICE (\$5 per industry person). On-site registration is \$10.00. Spouses and children under 18 will be admitted free of charge. Registration fees will be collected at EXPO 2016 entrance. Additional information is available at www.exporichmond.com		

Educational Course Information Thursday, May 12, 2016

Educational Workshops will be held Thursday, May 12, 2016. Hosted by the Department of Sustainable Biomaterials at Virginia Tech, presenters and topics will include: Brian Bond - **Vacuum Drying Opportunities for the Wood Products Industries**; Urs Buehlmann - **The American Housing Market & its impact on the Wood Products Industry**; Henry Quesada - **Lean Logistics: Identifying & measuring waste in your supply chain**; and Mike Snow (TBA) - **American Hardwood Exports**. More information regarding these programs will be available after January 1, 2016. Registration for Educational Courses is SEPARATE from the exposition registration. **YOU MUST REGISTER FOR EACH EVENT SEPARATELY**. Information regarding the Educational Courses will be available at www.sbio.vt.edu

THE AWARD-WINNING NORTHEASTERN FOREST PRODUCTS EQUIPMENT EXPOSITION

Where serious business is conducted

Thousands of hard working people plan to get together in Essex Junction, Vermont this May to conduct serious business. The Loggers' Expo is the largest and best exposition of supplies and services, heavy equipment and trucks – for loggers and land clearers, tree care professionals and firewood dealers, sawmillers and landowners. If you're serious about your business – you need to attend or exhibit in Essex Junction, Vermont.

🌲

2016 Loggers' Expo May 6-7, 2016, Champlain Valley Exposition Essex Junction, Vermont

For information about attending or exhibiting at the **2016 Loggers' Expo**, visit us online at www.northernlogger.com or call toll-free **800-318-7561** or **315-369-3078**.

Navigating the Challenges

HMA NATIONAL CONFERENCE & EXPO 2016

March 9-11
Fort Worth, Texas

Conference Highlights:

- Revenue & Profit Centers: Are you Leaving Money on the Floor?
- Hardwood Market Trends
- 2016 Hardwood Federation Legislative Update
- Leveraging the Generational Differences in the Workplace
- Improving your Risk Profile to Slash your Rates
- Continuing the Conversation – Industry Confab
- Lessons from the ashes: The critical role of leadership in promoting safety
- Global Economic Outlook

HMA
Hardwood Manufacturers Association

✉ 665 Rodi Road, Suite 305, Pittsburgh, PA 15235
☎ **p:** 412-244-0440 📠 **f:** 412-244-9090
✉ **e:** jlowe@hardwood.org
🌐 AmericanHardwds 📘 American Hardwood Information Center
📄 Register online at www.HMAmembers.org

MILLTREE™

LUMBER HOLDINGS
A MILLWOOD, INC. COMPANY

Hardwood Pre-Cut Pallet Material

- **#1 and #2 Material**
(Available in deck boards and runners.)
- **Various Sizes & Lengths**

Other Products Available
Sawdust • Mulch • Raw Bark • Boiler Fuel
Chips • Chunk Wood • & MORE

Call 740-226-2090 | www.millwoodinc.com



HUGE EQUIPMENT AUCTION

FORMERLY ALLEN LOGGING

MARCH 10th, 2016 • 9AM PT

Forks, Washington

Rolling Stock Sells at 12 NOON SHARP!
SAWMILL, PLANER MILL & ROLLING STOCK



ACCEPTING CONSIGNMENTS

Toll Free: 800-598-3651

www.associatedauctioncompany.com
 Associated Auction & Liq. Co.
 PO Box 147 Clarksburg, TN 38324
 Fax: 731-986-4529
sales@associatedauctioncompany.com



Bid Live Online via
www.proxibid.com



Join Our Mailing List! Call or E-mail for Complete Brochure
 Auctioneer Tommy Ingram, Washington Lic #3033,
 TN Firm# 5524



... HIGHLIGHTS ...

**Nicholson A1 60" Ring Debarker – Can-Car Chip-n-Saw Line –
 Nicholson A5 22" Ring Debarker – Whole Tree Chipper – Weldon
 Wood Fired Boiler – Complete Planer Mill – Several Steel Buildings –
 Large Amount of Rolling Stock – Truck Repair Shop**



TERMS: Full Payment day of Auction either by cash or cashiers check. Personal or Company checks will only be accepted when accompanied with an irrevocable verifiable bank letter of guarantee with statement of limit. Full payment must be made before leaving the sale location. Equipment sold "AS IS – WHERE IS" with no expressed or implied warranties. Sale Day Announcements will take precedence over any written material. **10% Buyers premium On Site, 13% Buyer Premium Online & Phone Bidders.**

CHECK OUR WEBSITE WWW.ASSOCIATEDAUCTIONCOMPANY.COM FOR UPDATED INVENTORY LISTING

MARK YOUR CALENDARS - DON'T MISS THIS SALE!

NOKOMIS SAWMILL

W5299 SELMER RD, TOMAHAWK, WI

MARCH 19th, 2016, 10AM

**CORINTH SAWMILL • PRECISION SCRAGG MILL
MORBARK DEBARKER • CROSBY EDGER • COMPLETE
FILING ROOM • LOADERS • CONVEYORS OF ALL KINDS**

- MORBARK MODEL C16 DEBARKER, WITH 60HP HYDRAULIC MOTOR, POWER ROLLER INFEED AND HOUR GLASS ROLLER OUTFEED AND BOTTOM MOUNTED VIBRATING BARK CONVEYOR
- 54" CORINTH CIRCULAR SAWMILL WITH 150HP MOTOR; LAHARCO DUAL LIGHT BEAM ALIGNMENT SYSTEM; OPERATORS CAB WITH CONTROLS AND MONITOR, & LOG TURNER
- GRADING DECK WITH ALL CONVEYORS
- PRECISION SAWMILL SYSTEMS MODEL SHARP CHAIN SCRAGG SAW WITH ALL IN/OUT FEEDS
- CROSBY EDGER WITH LASER LIGHTS
- 54" MCDONOUGH HORIZONTAL BAND RESAW W/RUN AROUND SYSTEM - IN GREAT CONDITION!

- 8' UNSCRAMBLER, CHAIN DECKS, LOG & LUMBER DECKS AND CONVEYORS OF ALL TYPES AND SIZES
- 2 SAW TRIMMER WITH CARBIDE SAWS
- 58" 6K PRECISION HUSKY CHIP-PAC - LIKE NEW
- QUINCY MODEL 5120 RECIPROCATING AIR COMPRESSOR
- COMPLETE FILING ROOM INCL. HANCHETT MODEL 82 BENCH SAW LEVELER
- 1992 JOHN DEERE MODEL 544E WHEEL LOADER
- 1996 KAWASAKI END LOADER WITH 48" FORK AND BALER TYPE ATTACHMENT
- PARTS, SAWS, KNIVES, TOOLS - PLUS MUCH MUCH MORE!



**VISIT OUR WEBSITE
ASSOCIATEDAUCTIONCOMPANY.COM
FOR UPDATED INVENTORY LISTING**



**ASSOCIATED AUCTION
& LIQUIDATION CO.**
PO Box 147 Clarksburg, TN 38324
Fax: 731-986-4529

**sales@associatedauctioncompany.com
Toll Free: 800-598-3651**

Auctioneer: Tommy Ingram, WI Lic# 2190-052, TN Firm# 5524

**Join Our Mailing List! Call or E-mail for
Complete Brochure!**

**Bid Live Online via
www.proxibid.com**

TERMS: Full Payment day of Auction either by cash or cashiers check. Personal or Company checks will only be accepted when accompanied with an irrevocable verifiable bank letter of guarantee with statement of limit. Full payment must be made before leaving the sale location. Equipment sold "AS IS - WHERE IS" with no expressed or implied warranties. Sale Day Announcements will take precedence over any written material. 10% Buyers premium On Site, 13% Buyer Premium Online & Phone Bidders.

OUR UNIQUE & INNOVATIVE WOOD DRYING PROCESS DELIVERS RESULTS



BRIGHTER LUMBER MEANS HIGHER SALES

Nova Dry Kiln's innovative technology offers a unique drying method that is kinder and gentler to the wood drying process. This process results in brighter lumber and gives our customers higher sales. Nova Dry Kiln builds and designs medium and large kilns ranging from 5,500 to 120,000 or more board feet.

TIMBER DRY MANAGEMENT CONTROLS OFFER FLEXIBILITY AND EASE OF USE

When using the Timber Dry Management System kiln operators have a straight forward, simple to use, flexible program. Kiln operators can make instant changes on the touch screen interface that is provided for each individual kiln. This drying control technology uses the exclusive proven and cost-saving Nova Dry Kiln methodology.

INNOVATIVE TECHNOLOGY SAVES MONEY ON UTILITIES AND DEGRADE

Our kilns not only save money on utilities but our customers experience end results of only a 1 to 1 1/2% degrade. Using the combination of a thermal blanket created from our heated floors, with fans that do not reverse rewetting the lumber surface, also moisture is not reintroduced into the drying chamber for humidity control or conditioning, to the aluminum-lined walls that offer a superbly insulated chamber, the Nova Dry Kiln saves you money on your utilities and provides you with a superior end product and in most cases only a 1 to 1 1/2% degrade.

CONTACT US FOR FURTHER DETAILS

We provide turnkey construction services along with excellent customer service as part of our dry solutions. Call our technical staff today for further information about Nova Dry Kiln and our Timber Dry Management system.



*Ask about our
Pallet Treating Kilns &
Firewood Kilns*

1-502-409-4539

www.novadrykiln.com • e-mail: info@novadrykiln.com



EFFICIENTLY REMOVE BY-PRODUCT WITH PENDU BLOWERS & BARK CONVEYORS

BLOWERS

- 4 and 6 blade fan designs
- Quality steel components
- 18", 26", and 42" models
- Alloy steel shafts, heavy-duty ball bearings
- Quiet operation



BARK CONVEYORS

- Easily move secondary products: bark, sawdust, shavings, etc.
- Straight line or any combination of degree angles
- Can be elevated up to 35° for material depositing into trucks, hoppers, or piles



**Stackers Trim Saws Gang Saws Scragg Mills Edgers
800.233.0471 717.354.4348 www.Pendu.com**



DOUBLE-CUT SAWMILLS

Extremely Fast!!

Visit our website for **NEW Products** in 2016... *trim saws, edger outfeed finger, rooftop chain deck*

Complete Sawmill Layout Options with full line of accessory equipment for the first transformation of wood
HELPING YOU TO GROW YOUR BUSINESS



"Authorized Dealer" for



U.S. Blades is your single source supplier of high quality knives, saws and related maintenance supplies for Sawmills & Chip Mills. With locations to serve mills throughout the Southern wood belt to the Northeast, U.S. Blades is here to support the Forest Products Industry providing new products as well as repair services.

U.S. Blades knives and saws are "Feared By Trees Everywhere."

U.S. Blades also has field service technicians for installation and service of all Armstrong equipment with many years of Armstrong parts and equipment knowledge that will benefit our customers.

Armstrong SDSC Territory Map

Shaded areas of this map represent U.S. Blades "Authorized" selling region.



Stocking Locations for "Genuine Armstrong Parts and Equipment"

LOCATIONS AUTHORIZED TO SELL:
 Florence, SC • Hampden, ME • Meridian, MS



usblades.net • 800-862-4544



Crosscut Solutions, Inc.

E5763 County Road B • Manawa, WI 54949

Ph: 920-596-2330 • Fx: 920-596-2324

crosscut@wolfnet.net

Pneumatic OR Mechanical

The industry's most durable pneumatic and mechanical cut-off saws, delivering smooth, accurate cuts for the manufacturing of flooring, windows and cabinets. Both saws are available with a cool mist lube system for the processing of aluminum.



Available in left or right hand

Mechanical Saw -
 No compressed air required

Pneumatic Saw -
 Cushioned air cylinders

www.crosscutsolutionsinc.com



Pallet Recycling Solutions from Smetco...



Stringer/
Board
Splicer



Notchers



Trim Saws



Turntables



Stackers



"Quick-Stack" System

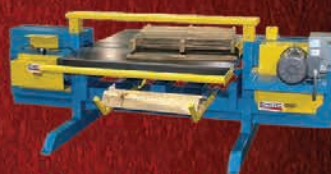

Dismantlers



Single End
Trim Saw

SMETCO also makes a complete line of repair and recycling equipment.



Sorting Systems

SMETCO, INC.
Pallet Handling Systems
PO BOX 560
AURORA OREGON 97002

Phone: 1-800-253-5400
Fax: 503-678-3095
www.smetco.com
sales@smetco.com



New Inserted Tooth for Cutoff Saws



B-ITCO

- Slasher Saw Operations
- Log Merchandising
- Firewood Processing

Bartlett's Saw Service & Supply
800-566-0319

PRECISION-BALANCED HOG ROTORS

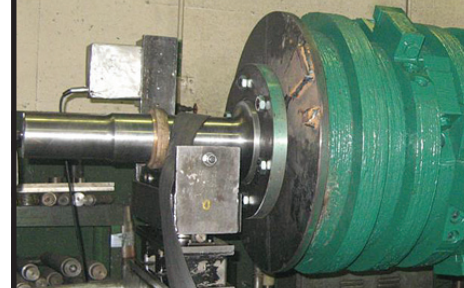

ELLISON SALES, INC.
Toll-Free: 888-244-0161
dan@ellisonsales.com

Used Machinery Call Mona Tracy Today

- 1- Pallet Shop, Ohio, NY, Iowa
- 1- Stake Machine - Chisel Cut
- 1- 2 Head Trim Saw
- 1- Air Compressor - Phase Converter
- 1- Morgan Portable Scragg
- 1- Gas Band Saw Disassembler
- 4- Nailing Jigs/Tables, Revo
- 1- 3 Head Trio Disassembler
- 2- Morgan Nailers & Stackers
- 1- Hand Held Brander
- 1- 12" Wide Resaw, Baker A
- 1- Band Saw Disassembler
- 1- Brewer D. A. Gang, Planer
- 1- Third Man Nailer
- 2- Pallet Kat Bandsaws
- 1- Vermeer Chipper VC-1000
- 1- KM-16 4 Head
- 1- Single Notcher
- 1- Chamfer
- Blowers, Phase Converter-40 HP
- 2- Morgan Dedusters
- 2- Solo, Pass I, Disassemblers
- 1- Tipper
- 1- Stacker 60 x 60
- 1- Complete Sawmill For Sale (NY)
- 1- Pallet Sizer - Resize Pallets
- 1- Pallet Chief I, II
- 1- Military Band Notcher
- 1- Gap Nailer
- 1- Rayco Pro
- 1- 4 Head Brewer w/Deduster
- 1- Baker Cut Off Saw
- 1- Cyclone Dust Collector Bag
- 1- Table Top Slinger/Plater

List your used
equipment with us!

UNIVERSAL
MACHINERY SALES, INC.

Toll Free **1-855-298-8890**
or **812-298-8090**
sales.universalmachinerysales@gmail.com

REAL TUFF Shavings Baler



Ben Jones Machinery

Div. of Dickert Enterprises, Inc.

Industry's Most Trusted Source

800-241-8983

See more equipment at
www.benjones.com

2008 Select Sawmill Model 4221 w/115 HP John Deere Diesel Engine



3500 hrs.
Location:
Pennsylvania
Ad #: 16873

\$75,000

In Operation

SAWMILL EXCHANGE
800-459-2148
www.sawmillexchange.com

Wood Fired **BOILER PARTS**
Supplies and Materials

PARTS IN STOCK

BOILER REPLACEMENT PARTS
Hurst Boiler is a major supplier of boiler parts and controls that are commonly found on most boiler systems. We warehouse and stock parts and supplies for gas, oil, coal or solid fuel systems. No matter the maker, Hurst can fill all your part needs.

The Industries Largest Supplier of Wood & Biomass Fired Boilers and Related Boiler Room Parts and Supplies

Pumps **Burners**
Controls **Refractory**
Gaskets **Fire Bricks**
Valves **Water Softeners**

CALL Parts Sales Dept. 1 877 774-8778
24 / 7 After Hours Parts 229 221-3338

OVERNIGHT DELIVERY

HURST BOILER & WELDING CO., INC.
100 Boilermaker Lane • Coolidge, GA 31738-0530
Tel: (229) 346-3545 • Fax: (229) 346-3874
email: info@hurstboiler.com

 hurstboiler.com

The Longest Lasting Debarker Head on the Market!

Why? Cutting Edge technology allows the carbide teeth to be indexed up to 6 times before they need replacing. That saves you money!



- 12" & 15" models
- Solidly constructed with All Steel bodies

The Bark-King Depth Control bearing can be used on many Rosserhead debarking heads to provide excellent control of the debarking process by preserving wood fiber.

Again — this saves you money!



So, get the #1 performing head on the market AND save money!
Find out more by calling

Stringer Industries, Inc.
1-601-876-3376
Or visit www.bark-king-tools.com



2 "TIPS"
FOR MONTGOMERY HOG OWNERS!!

Inventors of the
"SHANKLESS" 2-PIECE HARDFACED HAMMERS
Bring You
2 TIME-PROVEN MAINTENANCE SOLUTIONS



Replaceable-Tip Hammers for
XL-KC, CS-KC & PM-KC Montgomery Hogs



Available in
Overlapping-Cut & Hi-Rake Style, Too!

Replaceable-Tip Hammers and
Lower Teeth for Montgomery Hogs

PRECISION-MACHINED OUT OF OUR SPECIAL MATERIALS, THESE INSERTS WEAR LIKE HARDFACED PARTS!!

- PARTS FIT - FIRST TIME, EVERY TIME!
- No more shipping parts back and forth to be rebuilt!
- No more waiting for parts to get back to you!
- No messy hardfacing welding and grinding of hammers!
- No more cracking/breaking off of hardfacing!
- You can **"REBUILD" HAMMERS IN MINUTES!**

Need Other Parts, Screens or Rebuilds?
Call the experts with over 40 years experience!

 **ELLISON SALES, INC.**
TOLL-FREE: 1-888-244-0161
FAX: 503-293-0816
EMAIL: sales@ellisonsales.com • WEBSITE: www.ellisonsales.com

JAMES G. MURPHY CO. NO MINIMUMS - NO RESERVES



PUBLIC AUCTION



THE FORMER SIMPSON MILL IN DAYTON
9AM - TUESDAY - FEBRUARY 16, 2016



AUCTION TO INCLUDE: (2) LINDEN STEP FEEDERS - UNITED HYDRAULICS
REMOTE LOG LOADER - (1) KOCKUMS 66" CUT OFF SAW & (8) KOCKUMS 44" CUT OFF
SAWS - USNR 6' TWIN BAND CANTER LINE W/2013 PORTER SCANNING - 4-BAY SURGE
DECK - CAE NEWNES/MCGEHEE 6" CURVE SAWING GANG & CAE NEWNES/MCGEHEE
4" BOARD EDGER - PORTER/CAE NEWNES SCANNERS - COE 16' TRIMMER
COE 16', 15-BIN SORTER - COE 16' STICKER STACKER - JEFFREY 55WB HOG
(1) ACROWOOD 5216-6K CHIPPER & (2) CAE 62" 10K CHIPPERS
(6) EDEM BALANCED VIBRATORY CONVEYORS - BMM 10'X12' 2D CHIP SCREEN
(2) PEERLESS 40-UNIT CHIP BINS & (3) 30-UNIT CHIP BINS - CAROTHERS SURGE BIN
(3) WESTERN PNEUMATICS/TWIN CITY DUST COLLECTORS - (2) SULLAIR 350 HP
COMPRESSORS & (1) SULLAIR 150 HP COMPRESSOR - (1) AIR TEK 4000 SCFM & (1)
GREAT LAKES 800 SCFM DRYERS - (2) WAGNER L120 LOG STACKERS- JOHN DEERE 220
LC EXCAVATOR - CAT D8H DOZER - CAT 966F & 966C WHEEL LOADERS - (2) HYSTER
H210HD FORKLIFTS - HYSTER H210XL FORKLIFT HYSTER H190XL FORKLIFT - HYSTER
S50X FORKLIFT CAT 769 ROCK TRUCK - CASE 580E BACKHOE - BROCE RJ300 BROOM
- PETERBILT TRACTOR - KLEIN 26' TANKER - (4) PICKUPS - (2) TRUCKS - (110±) LOG
DECKS, HAULS, TRANSFERS, CONVEYORS & ROLLCASES (ALL W/REX OR SKK DRIVES)
MILL ELECTRICS - FILING ROOM EQUIPMENT - MILL SMALLS & STORES
AND MUCH MORE!



MURPHYAUCTION.COM - 1.800.426.3008
BID LIVE OR BID ONLINE WITH MURPHYLIVE



JAMES G. MURPHY CO. - NO MINIMUMS - NO RESERVES

JG M PUBLIC AUCTION JG M

THE CALIFORNIA REDWOOD COMPANY

9AM - WED & THURS - APRIL 6 & 7

5151 HIGHWAY 101 NORTH, EUREKA, CA 95503

200 KORBEL MILL ROAD, KORBEL, CA 95550

REMAN PLANT - ROLLING STOCK

ITEMS LOCATED IN EUREKA

- 2013 LINDE H80D-02 FORKLIFT
- 1979 HYSTER H200 FORKLIFT
- (4) HYSTER H190XL FORKLIFTS
- 2012 HYSTER H80FT SMALL FORKLIFT
- 1994 TAYLOR GT250 FORKLIFT
- 1978 TAYLOR TE 2205 FORKLIFT
- 1978 TAYLOR TE 1805 FORKLIFT
- 1976 CLARK L FORKLIFT
- (2) HYSTER M300H CARRIERS

ROLLING STOCK

- 1988 CATERPILLER 416 BACKHOE
- 1993 FORD F-150 PICKUP
- 1978 KUBOTA L1720 TRACTOR
- 1999 JOHN DEERE GATOR
- 1975 GROVE RT58 14 TON CRANE
- 1997 DODGE MAINTENANCE TRUCK
- 1991 GROVE MANLIFT MZ46A
- LARGE ASSORTMENT OF PICKUPS
- LARGE ASSORTMENT OF SUVs

REMAN EQUIPMENT

- (2) RESAWS
- (4) TRIMMERS (1) GMR
- TRAY SORTER
- (2) STACKERS
- BANDER
- (2) PLANERS
- (2) STICKER RECOVERY SYSTEMS
- MOULDER
- (4) TILT HOISTS
- (3) HULA SAWS
- (4) HOGS
- CHIP SCREEN
- (3) BAGHOUSES
- (2) BOILERS
- (3) HIGH PRESSURE BLOWERS
- (3) LOW PRESSURE BLOWERS
- (3) CHIP FEEDERS
- WALKING FLOOR
- (4) COMPRESSORS
- (4) AIR RECEIVERS
- KILN DOORS, CONTROLS, KILN CARTS,
- STICKERS, LUMBER
- FILING & GRINDING EQUIPMENT &
- STORES

ITEMS LOCATED IN KORBEL

LOG STACKERS

- 1998 LETOURNEAU 4594 LOG STACKER
- 1996 LETOURNEAU 2594SS LOG STACKER
- 1984 LETOURNEAU 2594SS LOG STACKER
- 1976 LETOURNEAU 2594S LOG STACKER

LOG LOADERS

- 2009 CAT 345C HEEL BOOM LOG LOADER
- 2001 JOHN DEERE 450LC HEEL BOOM
- 1996 KOMATSU PC300HD HEEL BOOM
- KOMATSU PC300HD3 HEEL BOOM

WHEEL LOADERS

- CAT 930 WHEEL LOADER
- JOHN DEERE 210C 4X4 SKIP LOADER
- BOBCAT RS0170 SKIDSTEER LOADER
- BOBCAT S175 SKIDSTEER LOADER
- BOBCAT MT55 SKIDSTEER LOADER

BACKHOE

- CASE 580C BACKHOE

FORKLIFTS

- TAYLOR T360L FORKLIFT
- (4) TAYLOR TE330L FORKLIFTS
- (2) TAYLOR GT280 FORKLIFTS
- (2) TAYLOR TE250M FORKLIFTS
- (2) TAYLOR TE180M FORKLIFTS
- (2) HYSTER FORKLIFT H360HDS
- (3) HYSTER H230XL FORKLIFTS
- 2002 HYSTER H190HD FORKLIFT
- HYSTER H150H FORKLIFT
- (2) HYSTER H50FT FORKLIFTS
- 2001 MITSUBISHI FG25 FORKLIFT

LARGE ASSORTMENT OF PICKUPS & SUVs

- (4) RELIANCE LUMBER TRAILERS
- 1974 KENWORTH W900 DUMP TRUCK

*INVENTORY SUBJECT TO MINIMAL CHANGE



MURPHYAUCTION.COM - 1.800.426.3008

JAMES G. MURPHY CO. - NO MINIMUMS - NO RESERVES

JGM PUBLIC AUCTION JGM

SEATTLE-SNOHOMISH MILL COMPANY

9AM - APRIL 27TH 2016

9525 AIRPORT WAY, SNOHOMISH, WA 98296

COMPLETE MILL AND ROLLING STOCK

2014 CAT 980K



2007 USNR KILNS



ROLLING STOCK

- 2014 CAT 980K WHEEL LOADER
- 2006 CAT 330D FM HEEL BOOM
- 2003 CAT 980G SERIES II WHEEL LOADER
- 1995 CAT 980F SERIES II WHEEL LOADER
- 2004 KUBOTA R520S 4X4 WHEEL LOADER
- 1987 KOMATSU PC400LC-3 HEEL BOOM
- (4) HYSTER H210XL FORKLIFT
- (2) HYSTER H210HD FORKLIFT
- (2) HYSTER H50XM FORKLIFT
- HYSTER H250XL FORKLIFT
- HYSTER H165H FORKLIFT
- HYSTER H200HS FORKLIFT
- HYSTER H180 FORKLIFT
- INTERNATIONAL 9400 TRACTOR
- HYSTER M200H STRADDLE CARRIER



MURPHYAUCTION.COM - 1.800.426.3008

LumberLine Laser



Now Available In Green!

24 month warranty
24 hour repair turnaround



5-30mW Units with a
range of input voltages
and configurations



sales@lumberlinelaser.com | toll free 855-686-3077 | www.lumberlinelaser.com

American Lumber & Pallet — Digital Edition —

Loaded with Pages and Pages
of New & Used Equipment and More!



The
NEW
amlumber.com

The latest, easiest
and most affordable way
to buy or sell used equipment...

For just one item to
an entire yard of inventory
— Check it out TODAY! —

www.amlumber.com!

KASCO
WOODMAXX Premium Band Saw Blades

CUTS WHAT OTHER BLADES CAN'T

MAXX4 4° Hook Angle
for frozen wood and extreme hardwoods;
maximum performance on all horsepower saws

MAXX7 7° Hook Angle
for frozen wood, tropical woods, and extreme hardwoods;
great for wider cuts on all species; performs better on
higher horsepower saws

Both are available in 7/8" tooth spacing (1.1 TPI) on 1-1/4" x 0.042", 1-1/4" x 0.045", 1-1/2" x 0.050, and 1-1/2" x 0.055" bands.

877.366.1696
www.WoodMaxxBlades.com

NEW HFP150 COMPACT FIREWOOD PRO From HAHN MACHINERY INC.

An affordable firewood processing attachment for those who use a lot of firewood but don't need the production capacity offered by the larger, more expensive commercial units.

Designed for use with most mid-sized and larger skid steer loaders, the new HFP150 Compact weighs 1700 lbs and requires a 15 gpm hydraulic flow.

Like its big brother, the HFP160 Firewood Pro commercial processor, the new HFP150 Compact can pick up a log up to 15" in diameter off the ground or deck, cut it into firewood lengths ranging from 12" to 20", and split those blocks into 2, 4, or 6 pieces with all functions being performed by one person from the comfort and safety of the loader's cab.

Please call **800-483-8825** or email info@hahnmachinery.com for a free DVD, complete specifications, and pricing.

HAHN MACHINERY INC • PO BOX 220
TWO HARBORS, MN 55616

www.HahnMachinery.com



Watch Hahn HFP 150 Compact online:
www.HahnMachinery.com

With the HFP150 Compact, the logs roll down the processor's forks into the machine's unique "shuttle trough" which carries the log up to the splitting wedge in 24" increments. Once the log is advanced to the cutting position, the trough retracts and a high speed hydraulic chainsaw cuts the firewood block. The block drops into the splitting trough and, as it's being split, the "shuttle trough" is carrying the next log segment in for cutting. The cycle is repeated until the entire log has been reduced to cut and split firewood.



Newnes 20' Optimizing Trimmer

LPS EQUIPMENT & ACQUISITION CO. **800-598-3651**
731-986-4351 | sales@lps-inc.com WWW.LPS-INC.COM

HIGH DEMAND FOR EXHIBIT SPACE AT EXPO RICHMOND 2016



Sales of exhibit space for the 35th East Coast Sawmill and Logging Equipment Exposition (**EXPO RICHMOND 2016**) are pacing well ahead of schedule with over 68% of the available space committed as of early December. The exposition is scheduled for May 13-14, 2016, at Richmond Raceway complex in Richmond, Virginia and will be 2016's largest showcase of sawmill, logging, pallet and related manufacturing equipment, supplies and services in the United States. It is co-sponsored by the Virginia Forest Products Association and the Cooperative Extension Service of Virginia Polytechnic Institute and State University.

A high percentage of companies who exhibited in **EXPO RICHMOND '14** have already signed up for the 2016 show. A high volume of inquiries from new exhibitors flood the show management offices daily. The Richmond show continues to be a valuable, cost-effective sales and marketing opportunity for exhibiting companies.

Don't miss your opportunity to be a part of EXPO Richmond 2016. For more information about either exhibiting or attending, please call (804) 737-5625, fax (804) 737-9437 or e-mail: Info@exporichmond.com. More information can be obtained by visiting ExpoRichmond.com.



Wanted to Buy Edger
Call Jeff **574-370-5050**
or e-mail:
jeff5743705050@hotmail.com

See Our New Equipment Website
www.kittrellsawmillbrokers.com
Request Our Award-Winning Newsletter with Equipment listings, Wanted Equipment, Appraisal information...and much more
Join our network and get your copy today!
Call us today **(931) 797-6284 TO GAIN ACCESS**

Dusty Boards A Problem?



Fix It With a Go Fast Deduster!!!

Under New Ownership!



Videos Available!

- Board Knocker System Nearly Eliminates All Stalls, Even With Frozen Boards
- Adjust Between Board Thicknesses In Under 60 Seconds!
- Standard With Steel Brushes
- No Dust Collection System Required
- Heavy Duty Steel Tubing Frame Construction
- Low Maintenance Machine
- Self-Contained Hydraulic System

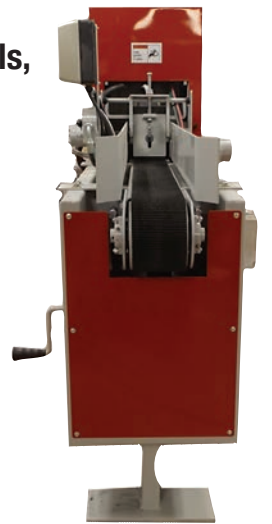

Be Sure To Check Out Our New Website! www.gofastmfg.com

1-800-854-7439

E-Mail: sales@gofastmfg.com • Fax: 920-227-1961

We Have New and Refurbished Units Available

Resaws • DeDusters • Chopsaws • Grade Systems • Parts

PRECISION CUTSTOCK!

GOLDEN EAGLE GANG SAW SYSTEM

- Dust Free Lumber
- Single, Double or Twin Double Arbors
- Built-In Planer Sizer
- 8" to 25" Bay Widths
- As Thin as .125 Kerf in Double Arbors
- Variable Feed Rates

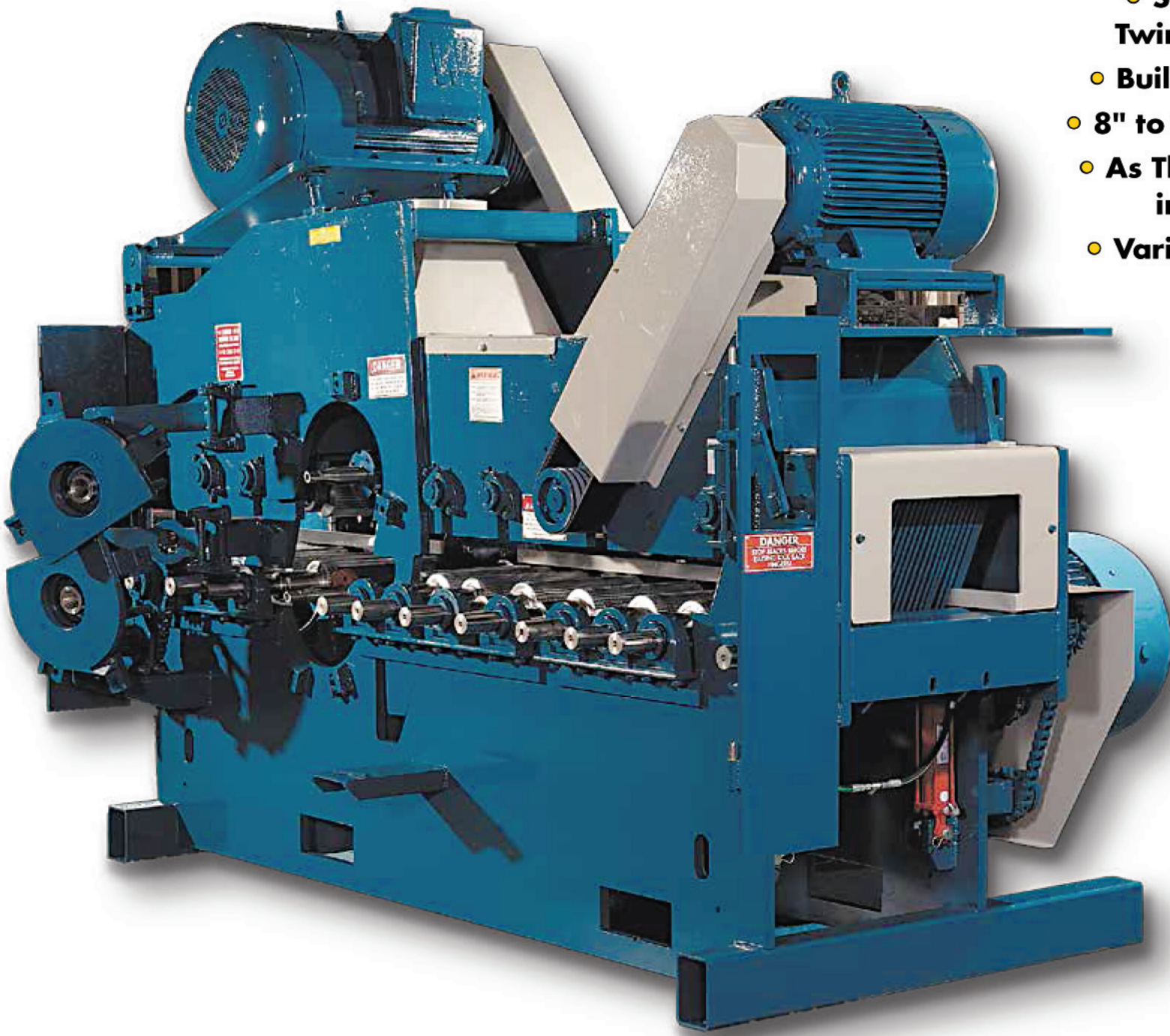

800-345-6516
www.brewermach.com

FULL PRODUCT LINES FOR PALLET, STAVE, GRADE AND RAIL TIE INDUSTRIES.

HOT ON THE MARKET!

Rough Terrain Forklift



Sellick Equipment Ltd. of Harrow, Ontario, Canada announces a new model of rough terrain forklift. The model S150, 15,000 lb. capacity @ 24" load center is now in full production. This new model is powered by an economical 74 HP 4 cylinder intercooled tier 4 final electronic engine that produces 295 ft/lbs of torque. Operator safety and comfort is consistent with all Sellick models. The S150 features a fully isolated operator platform that reduces noise and vibration, and the overhead guard structure is both ROPS and FOPS certified. Operators can monitor the machines systems through a multi-function digital LCD screen that also provides on board diagnostics that reduces downtime.

The S150 is designed for heavy industrial applications to meet the most demanding sawmill conditions. Established in 1969, Sellick Equipment continues providing quality rough terrain material handling products and support through a North American wide dealer network.

Call toll-free or email today for complete information, 1-877-735-4525 or sales@sellickequipment.com.

Model TX Pallet Stacker



NEW for 2016, PRS has introduced a newly remodeled version of their popular Model TX pallet stackers. These fully automatic pallet stackers are hydraulically powered, plc controlled and stack pallets at rates of 10-12 per minute. The new design features a simplified, low maintenance pallet gate, improved hydraulics and more manual over-ride features.

For more information, contact: PRS today (866) 546-8864 or visit their website at: <http://www.pallet-repair.com/equipment/Material-Handling/>

NEW PRODUCTS GET

HUGE

RESPONSE HERE!

Make sure to reserve your space in an upcoming issue.

For information, call

800-727-9684 or 800-992-3432, Ext. 4

or e-mail to

alp@amlumber.com

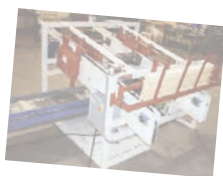

CNC Guide Dresser



Williams & White Equipment of Burnaby, BC has further expanded its product line with the introduction of its new CNC Guide Dresser. The company, a leading manufacturer of saw filing equipment for nearly 50 years, made a big splash last year with its highly anticipated saw sharpening center.

The new Guide Dresser accurately mills Babbitt to a tolerance of +/- .0002 inch at speeds up to 20 times faster than manual machines. The Williams & White model also significantly reduces floor space by using customized flexible fixturing to accommodate all saw guides on one machine (compared to the multiple manual machines typically used).

As one of the industry's largest steel and aluminum saw guide manufacturers, Williams & White knows the importance of accuracy. An accurate saw guide is critical in maximizing lumber recovery and profits.

For more information, contact: Williams & White Equipment 604-293-2268 • www.williamsandwhiteequipment.com

RETOOL REPOSITION RELAUNCH

 <p>1-1/2" RADIUS NOTCHING HEAD</p>	 <p>1/2" RADIUS INDEXABLE NOTCHING HEAD</p>		
 <p>HIGH SPEED BRAZED SURFACING HEADS</p>	 <p>INDEXABLE/ SIZER PLANNER HEAD</p>	 <p>FENCE POST PROFILE BRAZED HEAD</p>	 <p>CORNER ROUNDER INSERT HEAD</p>
 <p>INSERT CHAMFER CUTTERS</p>	 <p>INDEXABLE INSERTS & SAW TIPS</p>	 <p>EDGER/CHIPPER BRAZED HEAD</p>	 <p>NAILBUSTER® SAW BLADES</p>



**GENERAL PURPOSE
WOOD CUTTING SAW BLADES**

- STROB SAWS
- RIP SAWS
- CROSS CUT
- CUSTOM



CUTTING WOOD WITH NAILS
CUTTER HEADS • SAW BLADES
INDEXABLE INSERTS
20 YEARS EXPERIENCE



John Lieber, President

CUSTOM ENGINEERED TOOLING

PROFILE TECHNOLOGY INC.

9116 Rott Rd. St. Louis, MO 63127
TEL 314-965-9111 FAX 314-966-5550
info@profiletech.com www.profiletech.com

North America **800-369-4242** Since 1970



David Lieber, Sales Engineer

FOR SALE!

BREWER, IN GOLDEN EAGLE EQUIPMENT

Brewer Golden Eagle Resaw

LEERAY & LUKE HORTON
218-372-4232
E-Mail: llsales@frontiernet.net

DISMANTLING BARS
"LIFETIME WARRANTY"

from... **PRSPALLET REPAIR SYSTEMS, INC.**

SAME DAY STOCK SHIPMENT

Pallet Repair Systems, Inc. • 3550 Mayflower Blvd. • Springfield, IL 62707
PHONE: 217.291.0009 FAX: 217.291.0008
TOLL FREE: 866-546-8864 www.pallet-repair.com

WE REBUILD MONTGOMERY HOG ROTOR ASSEMBLIES

ELLISON SALES, INC.
Toll-Free: 888-244-0161
dan@ellisonsales.com

NOW BUYING

Used Pallet and Pallet Recycling Machinery

1-800-348-0703

NOBLE MACHINERY CO. INC.

STILL THE FASTEST SWING SAW FOR MOST CUT-OFF OPERATIONS

FAST! The H & A Swing Saw

- Up to 72 Cuts Per Minute
- Greater Capacity & Easiest Operation
- 3 Models All w/Best Safety Features

"Plants" Using OSHA Inspected & Approved

Call 1-800-397-3703
H & A Swing Saw Inc. • Since 1921
PO Box 127 • Lockridge, IA 52635

www.hasaws.com
email: hasaws10@lisco.com



NEW PRECISION 6x6 Chip Screen

Ben Jones Machinery
Div. of Dickert Enterprises, Inc.
Industry's Most Trusted Source
800-241-8983
See more equipment at www.benjones.com



Bandit Builds **Your Bottom Line.**



THERE ARE MANY REASONS WHY PROFESSIONALS AROUND THE WORLD TURN TO THE BEAST® FOR GRINDING AND RECYCLING PALLETS.

Rugged construction, excellent fuel economy, and exceptional performance. Bandit's patented cuttermill easily grinds pallets into any number of desirable end products – whether it's mulch, boiler fuel, or pellet stock. And powerful magnets trap metal nails before material leaves the discharge, helping ensure you have a cleaner, more valuable product.

Beast XP-Series Horizontal Grinders make you money... Bandit Builds your bottom line.

Let us prove it to you! Contact Bandit Industries today to set up a machine demonstration. Call 1-800-952-0178 or visit us online at www.banditchippers.com.



CHECK US OUT ON YOUTUBE!



Bandit INDUSTRIES, INC.

www.banditchippers.com | 1.800.952.0178 | Remus, MI - USA



silver^{Tip} *Wood-Mizer*
CARBON BANDSAW BLADES



Profile Ground Tooth
TIP TO TIP

Wood-Mizer's SilverTip blade is a **TOP-PERFORMING**, economical blade for primary and secondary wood processing.

Smith Sawmill Service

800.598.6344

181 Co Rd 4763
Timpson, TX 75975

The Wood-Mizer quality you love. The convenience you need.